

Caggiati[®]

CATALOGO
GENERALE
2018

INDICE



SERIE CALICE
P. 10 - 21

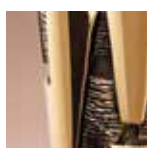

I PREZIOSI
CERA PERSA
P. 22 - 35



SHELL
MOULDING
P. 36 - 65

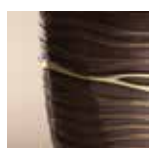

PRESSOFUSIONE
P. 66 - 109

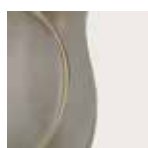

DECORATI
P. 110 - 121



BOTTICINO
P. 122 - 143

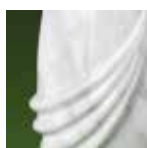

CARRARA
P. 144 - 165



VERDE ALPI
P. 166 - 169



UNIBLANC
P. 170 - 189



DARK
P. 190 - 199



ORO
P. 200 - 203



PORCELLANA
P. 204 - 221



ACCIAIO INOX
P. 222 - 245



CAGGIATI
DESIGN
P. 246 - 261



CARATTERI
BRONZO
P. 262 - 291



CARATTERI
INOX
P. 292 - 299

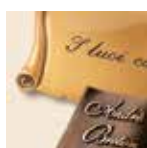

LIBRI E
PERGAMENE
p. 300 - 307



TARGHE
COMMEMORATIVE
p. 308 - 315



INCASSI
P. 316 - 323



ILLUMINAZIONE
P. 324 - 335



CORNICI
P. 336 - 345



CROCI E
CROCEFFISSI
P. 346 - 373

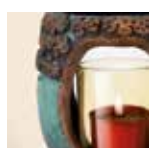

LAMPADE A
CERO
P. 374 - 385



MOTM
FLOREALI
P. 386 - 431



MOSAICI
P. 432 - 439



TARGHE
P. 440 - 465



STATUE E BUSTI
P. 466 - 509



CAPPELLE E
E SOSTEGNI
P. 510 - 521



STAFFE
BORCHIE
E ANELLONI
P. 522 - 531



PREFABBRICATI
P. 532 - 533



CREMAZIONE
CINERARI
E OSSARI
P. 534 - 551



CREMAZIONE
URNE
P. 552 - 565



CRISTALLI
DI LUCE
P. 566 - 601



ACCESSORI
P. 602 - 613



SISTEMI
ESPOSITIVI
P. 614 - 617

COME UTILIZZARE I LINK DEL CATALOGO DIGITALE CAGGIATI 2018

1



Link alla
prima pagina
della sezione

2

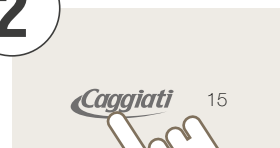

Link all'indice
delle sezioni

3

OGGETTISTICA ORNAMENTA			
	Codice Articolo	Descrizione	Pagina
1			
P	1 011/25P	Vaso	15
P	1 011/1	Vaso	173,186,544
P	1 011/2	Vaso	173

Link all'indice
progressivo per
codice



CATALOGO 2018

Matthews International S.p.A.

Sede Legale ed Uffici Direzionali: Via Martiri della Libertà, 71 - 43052 Colorno - Parma - Italy
Cap. i.v. € 2.500.000,00 - Partita Iva 02104230343 - Codice Fiscale 12475620154
Tel. +39 0521 5208 - Fax +39 0521 521148/0521 816777 - www.matw.it - servizio.clienti@matw.it

Uffici Commerciali ed Assistenza Clienti: Via Galileo Galilei, 1 - 43052 Colorno - Parma - Italy
Tel. +39 0521 815801 - Fax verde 840 022444 - www.caggiati.it - servizio.clienti@caggiati.it

Capacità, Conoscenza e Dedizione,
un patrimonio umano indispensabile per creare l'esclusività ed il prestigio di un prodotto Caggiati.

Capacité, Connaissance et Dévouement,
un patrimoine humain indispensable pour créer l'exclusivité et le prestige d'un produit Caggiati.

Capacidad, Conocimiento y Dedicación,
un patrimonio humano indispensable para crear la exclusividad y el prestigio de un producto Caggiati.

Capability, Knowledge and Dedication,
a human heritage, indispensable to create the exclusivity and prestige of a Caggiati product.

Leistungsfähigkeit, Wissen und Hingabe
ein humaner Reichtum - auf den man nicht verzichten kann, um die Exklusivität und das Prestige eines Caggiati-Produktes zu erreichen.



*Esperienza, Tecnologia e Precisione,
Organizzazione, Determinazione e Logistica.
elementi fondamentali di una qualità superiore.*

*Expérience, Technologie et Précision,
Organisation, Détermination et Logistique.
les éléments fondamentaux d'une qualité supérieur.*

*Experiencia, Tecnología y Precisión,
Organización, Determinación y Logística.
elementos fundamentales de una calidad superior.*

*Experience, Technology and Precision,
Organisation, Determination and Logistics.
fundamental elements of superior quality.*

*Erfahrung, Technologie und Präzision,
Organisation, Bestimmtheit und Logistik.
grundlegende Elemente einer hohen Qualität.*



Come si legge il catalogo

Comment se lit le catalogue

How the catalogue is read

Cómo se lee el catálogo

Wie der katalog zu lesen ist



Diamond Shield



Bronzo 87

Gli articoli rappresentati sono proporzionati fra loro.

Les articles représentés sont proportionnés entre eux

Articles are shown proportionate one to another

Los artículos se representan proporcionados los unos con los otros

Die dargestellten Artikel sind untereinander proportioniert

L'immagine può variare in base alle misure dell'articolo.

L'image peut différer en fonction des mesures de l'article.

The image may vary depending on the measures of the product.

La imagen puede variar de conformidad con las medidas del producto.

Das Bild kann abhängig von den Abmessungen des Produkts abweichen.

I colori dei prodotti rappresentati nelle immagini fotografiche di questo catalogo possono essere leggermente differenti dal vero considerati i limiti della riproduzione a mezzo stampa rispetto alla realtà.

Les couleurs des produits présentés sur les images photographiques de ce catalogue peuvent être légèrement différentes des vraies compte tenu des limites de la reproduction au moyen d'une imprimante par rapport à la réalité.

The colour of the products shown in the photographs in this catalogue can be slightly different than they appear in reality due to the limited possibilities offered by printing processes.

Los colores de los productos que aparecen en las imágenes fotográficas de este catálogo pueden diferir ligeramente de los reales, debido a las limitaciones de la reproducción por impresión para reflejar la realidad.

Die Farben der in den Fotografien dieses Kataloges dargestellten Produkte können sich leicht von den echten Originalen unterscheiden, da die Druckwiedergabe in Bezug auf die Wirklichkeit ihre Grenzen kennt.



Articolo con attacco a parete

Article à appliquer
Wall-attached article
Artículo a pared
Artikel mit Wandbefestigung



Articolo con attacco a terreno

Article à poser
Ground-attached article
Artículo a tierra
Artikel mit Bodenbefestigung

1 030/20 R

Codice dell'articolo

Article code
Artículo code
Artikel

Tipo di interno del portafiori

Type d'interne des porte-fleurs
Type of vase-holder interior
Tipo de interior de búcaros
Art der Blumenständer - Innenfläche

Simbologie impiegate per le dimensioni degli articoli

Symboles utilisés pour les dimensions des articles
Symbols used for sizes of articles
Símbolos empleados para las dimensiones de los artículos
Gebrauchte Symbole für den Umfang der Artikel



Rame, alluminio e altri metalli

Cuivre, aluminium et autres métaux
Copper, aluminum and others metals
Cobre, aluminio y otros metales
Kupfer, Aluminium und anderen edlen Materialien



Plastica - Plastique - Plastic - Plastico - Plastik



Altezza
Hauteur
Height
Altura
Höhe



Sporgenza e/o profondità
Profondeur
Projection
Profundidad
Vorsprung



Base
Base
Base
Base
Basis

Indicazioni per l'ordinazione. Per l'ordinazione riportare solamente il numero di codice e l'altezza dell'articolo.

Avvertenza: tutti i disegni, i modelli e stampi sono di esclusiva proprietà della Matthews International S.p.a. e quindi sono tutelati dalle norme in materia di diritto d'Autore. La loro riproduzione parziale o totale è pertanto vietata.

Indications pour les commandes. Pour les commandes, il suffit d'indiquer le numéro de code et la hauteur des articles désirés. Avertissement: tous les dessins, modèles et illustrations sont la propriété exclusive de la Matthews International S.p.a. et sont protégés par la législation sur les droits d'auteurs. Toute reproduction partielle ou totale en est interdite.

Instructions for orders. To place an order please note only the reference number and the height of the article.

Note: all the design models are the exclusive property of Matthews International S.p.a. and all rights are therefore reserved. The reproduction of partial or all is strictly forbidden.

Indicaciones para su pedido. Para hacer su pedido debe hacer constar solamente el número de código y la altura del artículo.

Advertencia: todo diseño y modelo impreso es de la única y exclusiva propiedad de Matthews International S.p.a., y por lo tanto están protegidos por la ley de derechos de autor. La sola reproducción parcial o total está rigurosamente prohibida.

Bestellangaben. Bei der Bestellung ist nur die Kode-Nr. und die Höhe des Artikels anzugeben.

Hinweis: sämtliche Zeichnungen, Modelle und Formen sind ausschließliches Eigentum der Matthews International S.p.a. und sind insofern durch das Gesetz des Urheberrechts geschützt. Ihre partielle oder komplette Nachahmung ist verboten.



"In un contesto di grande competitività e cambiamento, Matthews ha da tempo intrapreso, in modo deciso, una strada di sviluppo improntata sulla qualità senza compromessi; un modo di operare che ha permesso all'azienda di divenire Leader indiscusso del proprio mercato.

Il nostro percorso di eccellenza trova oggi concretizzazione in un nuovo progetto che abbiamo voluto chiamare INFINITA, a rappresentare l'importanza del nostro impegno, a lungo termine, per la gestione di una qualità superiore.

INFINITA è il nuovo cuore delle attività Matthews, un concetto che abbraccia ogni comportamento e ci guiderà nel futuro, per definire, in modo chiaro e preciso, il percorso da seguire.

INFINITA, per il cliente, significa certezza; certezza di avere come partner un'azienda che è impegnata a fondo nella scelta delle migliori materie prime, nell'utilizzo di sistemi produttivi all'avanguardia, di durata nel tempo, di impegno ambientale, di investimenti per la sicurezza dei lavoratori, di qualità dei servizi commerciali, informativi e di comunicazione.

INFINITA è il nuovo marchio Matthews che certifica l'eccellenza di ogni comportamento aziendale, per gestire ed organizzare ogni fase di vita del prodotto, secondo i più moderni criteri di qualità globale, per garantire la perfezione ed il valore di un investimento sicuro e duraturo nel tempo".

Matthews International S.p.A.

INFINITA

Excellence, Protection, Duration, Safety, Environment

"Within a context of great competitiveness and change, Matthews has clearly chosen a development approach based on quality without compromise.

This approach led the company to become the undisputed leading player on its market.

Today our approach to excellence translates into a new project we decided to call INFINITA, since it accounts for the scope of our long-term efforts aimed at the management of superior quality.

INFINITA is the new heart of Matthews' activities, a concept embracing all behaviours which in the future will guide us in providing a clear and precise definition of the approach to be implemented.

For our customers, INFINITA means certainties: The certainty of establishing a partnership with a company deeply committed to the selection of the best raw materials, the implementation of avant-garde production systems, to long life, the protection of the environment, investments for the safety of workers, the quality of business, information and communication services.

INFINITA is Matthews' brand meaning excellence in all corporate behaviours according to the most modern global quality criteria, to ensure perfection and safe investment values lasting in time".

Matthews International S.p.A.

INFINITA

Excellence, Protection, Durabilité, Sécurité, Environnement

"Dans un contexte de grande compétitivité et de grands changements, Matthews a entrepris depuis déjà longtemps et avec une grande détermination, un parcours de développement fondé sur une qualité sans compromis, une méthode qui nous a permis de devenir le leader indiscutable du marché. Notre parcours d'excellence se concrétise aujourd'hui dans un nouveau projet que nous avons appelé INFINITA, pour souligner l'importance de notre engagement à long terme, pour la gestion d'une qualité supérieure.

INFINITA est le nouveau cœur des activités de Matthews, un concept qui embrasse chaque comportement de l'entreprise et qui nous guidera à l'avenir pour définir la voie à suivre de manière claire et précise. INFINITA, pour le client, signifie certitude; la certitude d'avoir comme partenaire une entreprise qui s'est engagée à fond dans le choix des meilleures matières premières, dans l'utilisation de systèmes de production d'avant-garde, sous le signe de la durabilité, de l'engagement environnemental, d'investissements pour la sécurité des travailleurs et pour la qualité des services commerciaux, d'information et de communication. INFINITA est la nouvelle marque de Matthews qui certifie l'excellence de chaque comportement en entreprise afin de gérer et d'organiser chaque phase de la vie du produit selon les critères les plus modernes".

INFINITA est le nouveau cœur des activités de Matthews, un concept qui embrasse chaque comportement de l'entreprise et qui nous guidera à l'avenir pour définir la voie à suivre de manière claire et précise. INFINITA, pour le client, signifie certitude; la certitude d'avoir comme partenaire une entreprise qui s'est engagée à fond dans le choix des meilleures matières premières, dans l'utilisation de systèmes de production d'avant-garde, sous le signe de la durabilité, de l'engagement environnemental, d'investissements pour la sécurité des travailleurs et pour la qualité des services commerciaux, d'information et de communication. INFINITA est la nouvelle marque de Matthews qui certifie l'excellence de chaque comportement en entreprise afin de gérer et d'organiser chaque phase de la vie du produit selon les critères les plus modernes".

INFINITA est le nouveau cœur des activités de Matthews, un concept qui embrasse chaque comportement de l'entreprise et qui nous guidera à l'avenir pour définir la voie à suivre de manière claire et précise. INFINITA, pour le client, signifie certitude; la certitude d'avoir comme partenaire une entreprise qui s'est engagée à fond dans le choix des meilleures matières premières, dans l'utilisation de systèmes de production d'avant-garde, sous le signe de la durabilité, de l'engagement environnemental, d'investissements pour la sécurité des travailleurs et pour la qualité des services commerciaux, d'information et de communication. INFINITA est la nouvelle marque de Matthews qui certifie l'excellence de chaque comportement en entreprise afin de gérer et d'organiser chaque phase de la vie du produit selon les critères les plus modernes".

INFINITA est le nouveau cœur des activités de Matthews, un concept qui embrasse chaque comportement de l'entreprise et qui nous guidera à l'avenir pour définir la voie à suivre de manière claire et précise. INFINITA, pour le client, signifie certitude; la certitude d'avoir comme partenaire une entreprise qui s'est engagée à fond dans le choix des meilleures matières premières, dans l'utilisation de systèmes de production d'avant-garde, sous le signe de la durabilité, de l'engagement environnemental, d'investissements pour la sécurité des travailleurs et pour la qualité des services commerciaux, d'information et de communication. INFINITA est la nouvelle marque de Matthews qui certifie l'excellence de chaque comportement en entreprise afin de gérer et d'organiser chaque phase de la vie du produit selon les critères les plus modernes".

Matthews International S.p.A.

INFINITA

Excelencia, Protección, Durabilidad, Seguridad, Ambiente

"En un contexto de gran competitividad y cambio, Matthews ha emprendido, desde hace tiempo y de manera decidida, un camino de desarrollo distinguido por la calidad sin compromisos; un modo de trabajar que le ha permitido a la empresa posicionarse como líder indiscutido en su propio mercado.

Hoy día, nuestro camino de excelencia se ha concretado mediante un nuevo proyecto, que hemos querido llamar INFINITA, a través del cual buscamos destacar la importancia que adquiere nuestro compromiso a largo plazo para la gestión de una calidad superior. INFINITA es el nuevo corazón de las actividades de Matthews, un concepto que abraza cualquier comportamiento y que nos guiará hacia el futuro para definir, de manera clara y precisa, el camino a seguir.

INFINITA, para el cliente, significa certeza; certeza de tener como socio a una empresa que está profundamente comprometida con la elección de las mejores materias primas, el uso de sistemas productivos de avanzada, durabilidad en el tiempo, responsabilidad ambiental, inversiones para garantizar la seguridad de los trabajadores, calidad en los servicios comerciales, informativos y de comunicación.

INFINITA es la nueva marca Matthews que certifica la excelencia de los comportamientos empresariales en la gestión y organización de todas las fases de vida del producto, conforme a los más modernos criterios de calidad global, a fin de garantizar la perfección y el valor de una inversión segura y duradera en el tiempo".

Matthews International S.p.A.

INFINITA

Exzellenz, Schutz, Dauerhaftigkeit, Sicherheit, Umwelt

"Im Rahmen eines starken Wettbewerbs und der Veränderungen hat Matthews schon seit langem schlagkräftig den Weg der Entwicklung im Zeichen einer kompromisslosen Qualität eingeschlagen. In dieser Weise hat sich das Unternehmen zum unbestrittenen Marktführer entwickelt.

Unser Streben nach Exzellenz hat sich heute in einem neuen Projekt konkretisiert, das wir wie das Unendliche INFINITA genannt haben, um die langfristige Bedeutung unseres Schaffens zugunsten einer gehobenen Qualität darzustellen. INFINITA ist die neue Kernaktivität von Matthews, ein Konzept, das alle Schritte umfasst und uns in die Zukunft führt, um deutlich und genau den richtigen Weg zu bestimmen.

INFINITA bedeutet für unsere Kunden Gewissheit; Die Gewissheit eines Partners, der für eine gründliche Wahl der besten Rohstoffe sorgt, für den Einsatz hochmoderner Produktionssysteme, für Dauerhaftigkeit, Umweltschutz, Investitionen für die Sicherheit der Arbeiterschaft, Qualität der Serviceleistungen für Vertrieb, Information und Kommunikation.

INFINITA ist die neue Marke von Matthews – als Zeugnis der Exzellenz aller Verfahren des Unternehmens, die alle Lebensphasen des Produkts nach den modernsten globalen Qualitätsmaßstäben verwalten und organisieren und die Perfektion und den Wert einer sicheren und dauerhaften Investition garantieren."

Matthews International S.p.A.

“UNA LAPIDE
POSTA A
RICORDO È
L'ULTIMO GESTO
DI UN AMORE
ETERNO”



NUOVA
COLLEZIONE
CALICE



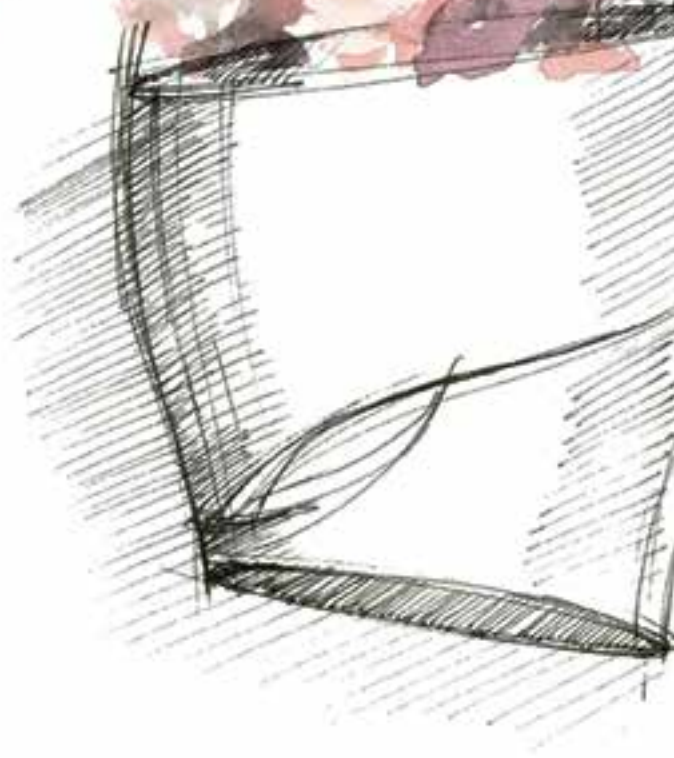
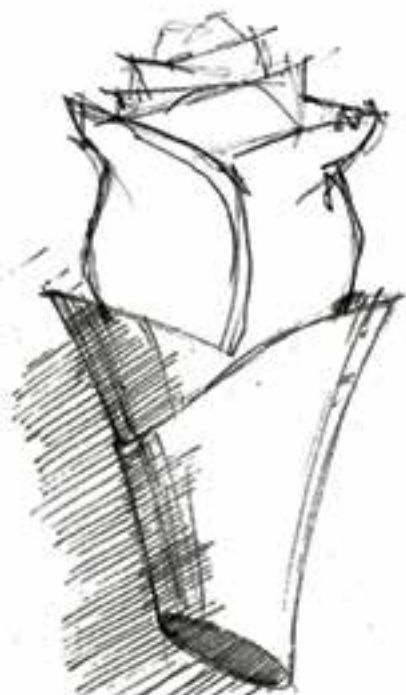

Calice racchiude un'infiorescenza
prima che sbocci, proteggendola.

Il disegno si compone
di due elementi uniti dal decoro
leggero di una foglia che
impresiosisce e caratterizza
la collezione.

Questa unione permette di abbinare
differenti cromie e finiture dando
la possibilità di creare molteplici
composizioni.

Realizzata in pressofusione,
la collezione si completa con
il portalume che avvolge il cristallo
votivo in forma di bocciolo.







portafiori
vasche
lampade

porte-fleurs
vases
lampes

vases
and lamps

bucaros
jardineras
lamparas

blumenvasen
schalen
lampen



CALICE BRONZO

Designed by Habits Studio



P 1 001/25P ⓘ
cm ±25x9,2x10

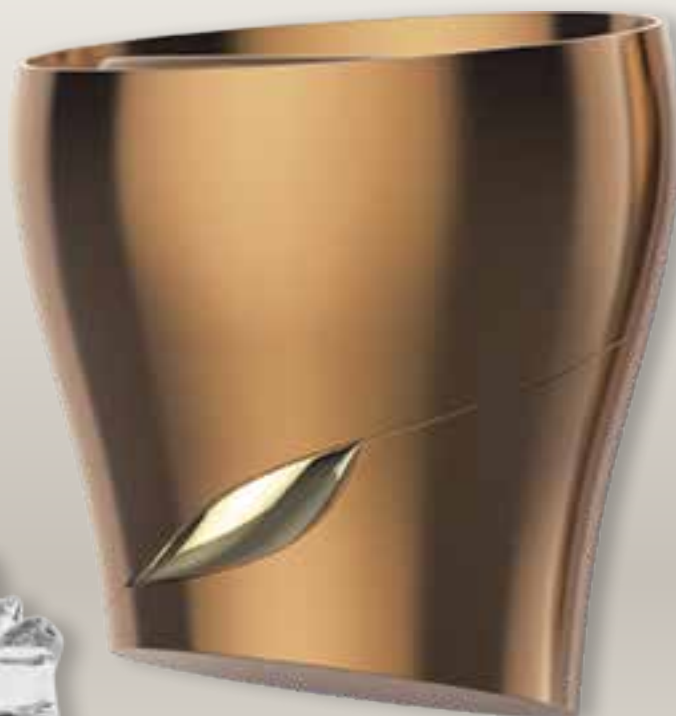

P 2 302/20P ⓘ
cm ±20x19,2x12



P 9 401/19
cm ±19x8,2x8
Con Fiamma di cristallo
98 041/0 inclusa



portafiori
vasche
lampade

porte-fleurs
vases
lampes

vases
and lamps

bucaros
jardineras
lamparas

blumenvasen
schalen
lampen



CALICE BRONZO/CLASSIC

Designed by Habits Studio



P 1 047/25P ⓘ
cm ±25x9,2x10



P 2 313/20P ⓘ
cm ±20x19,2x12



P 9 424/19
cm ±19x8,2x8
Con Fiamma di cristallo
98 041/0 inclusa



portafiori
vasche
lampade

porte-fleurs
vases
lampes

vases
and lamps

bucaros
jardineras
lamparas

blumenvasen
schalen
lampen



CALICE

BOTTICINO/BRONZO

Designed by Habits Studio



P 1 053/25P ⓘ
cm ±25x9,2x10



P 2 324/20P ⓘ
cm ±20x19,2x12



P 9 435/19
cm ±19x8,2x8
Con Fiamma di cristallo
98 041/0 inclusa



portafiori
vasche
lampade

porte-fleurs
vases
lampes

vases
and lamps

bucaros
jardineras
lamparas

blumenvasen
schalen
lampen



CALICE

CARRARA/CROMINOX

Designed by Habits Studio



P 1 089/25P ⓘ
cm ±25x9,2x10



P 2 357/20P ⓘ
cm ±20x19,2x12



P 9 468/19
cm ±19x8,2x8
Con Fiamma di cristallo
98 041/0 inclusa



I PREZIOSI
CERA PERSA



EVOLUTION

Direzione creativa Fabio Ragni



portafiori
vasche
lampade

porte-fleurs
vases
lampes

vases
and lamps

bucaros
jardineras
lamparas

blumenvasen
schalen
lampen



P 1 030/20R

cm ±20x11,±11,5

T 1 032/20R

cm ±20x11,±ø 7

P 7 034/19

cm ±18x8,±ø 8,5

T 7 063/19

cm ±18x8,±ø 6

P 2 172/18R

cm ±18x17,±11

T 2 189/18R

cm ±18x17,±13x8



P 23 005/15

cm ±14,5x7

P 23 005/20

cm ±19,5x9,5



P 19 002/09

cm 9x12

P 19 002/11

cm 11x15



T 10 005/25

cm ±25x13,±10x10



T 7 063/19

cm ±18x8,±ø 6



T 1 032/25R

cm ±23x15,±ø 9,5

portafiori
vasche
lampade

porte-fleurs
vases
lampes

vases
and lamps

bucaros
jardineras
lamparas

blumenvasen
schalen
lampen



EVOLUTION GOLD

Direzione creativa Fabio Ragni



P 1 038/20R

cm ±20x11,±11,5

T 1 040/20R

cm ±20x11,±ø 7

P 7 073/19

cm ±18x8,±8,5

T 7 096/19

cm ±18x8,±ø 6

P 2 200/18R

cm ±18x17,±11

T 2 216/18R

cm ±18x17,±13x8



P 23 010/15

cm ±14,5x7

P 23 010/20

cm ±19,5x9,5



P 19 014/09

cm 9x12

P 19 014/11

cm 11x15



T 10 021/25

cm ±25x13,±10x10



T 7 096/19

cm ±18x8,±ø 6



T 1 040/25R

cm ±23x15,±ø 9,5

FEDELTÀ

Designed by Claudia Storci



portafiori
vasche
lampade

porte-fleurs
vases
lampes

vases
and lamps

bucaros
jardineras
lamparas

blumenvasen
schalen
lampen



P 4 010/20 ◉
cm ±20x12,5±13

P 4 237/19 ◉
cm ±19x18,5±13

P 7 021/20
cm ±21x9,5±9,5



P 19 063/07 cm 7x9
P 19 063/08 cm 8x10
P 19 063/09 cm 9x12
P 19 063/11 cm 11x15
P 19 063/13 cm 13x18



P 21 012/09 cm 9x12
P 21 012/10 cm 10x15
P 21 012/11 cm 11x15
P 21 012/13 cm 13x18

portafiori
vasche
lampade

porte-fleurs
vases
lampes

vases
and lamps

bucaros
jardineras
lamparas

blumenvasen
schalen
lampen



FEDELTÀ

CINERARI E OSSARI



P 7 021/15
cm ±15x7,±7,5



P 4 010/13 ●
cm ±13x8,5,±9



P 10 611/18
cm ±18x14,±12,5



T 7 035/27
cm ±27x11,±5,5



T 4 021/30 ●
cm ±30x15,±6



T 10 622/24
cm ±24x19,±8,5

GARDEN

Designed by Pietro Zegna



portafiori
vasche
lampade

porte-fleurs
vases
lampes

vases
and lamps

bucaros
jardineras
lamparas

blumenvasen
schalen
lampen



P 6 452/22 ⓘ
cm :20x14,~12

P 6 439/17 ⓘ
cm :17x20,5,~10

P 9 819/22
cm :22x12,~10



P 19 005/09
cm 9x12



P 21 010/09
cm 9x12



I 13 516/17
cm :17,~ø13,5



I 13 057/4 ⓘ
cm :4,~ø21



I 10 186/15
cm :15,~ø21



P 10 344/19
cm :19x14,~12,5

P 19 005/11
cm 11x15

P 21 010/10
cm 10x15

P 21 010/11
cm 11x15

portafiori
vasche
lampade

porte-fleurs
vases
lampes

vases
and lamps

bucaros
jardineras
lamparas

blumenvasen
schalen
lampen



GARDEN DECORATA

Designed by Pietro Zegna



P 4 712/22 
cm ±20x14,~12

P 6 441/17 
cm ±17x20,5,~10

P 9 592/22
cm ±22x12,~10



P 19 008/09 cm 9x12

P 19 008/11 cm 11x15



P 21 018/09 cm 9x12

P 21 018/10 cm 10x15

P 21 018/11 cm 11x15



P 10 346/19
cm ±19x14,~12,5

CELLINI

Designed by Gianluca Ugoletti - Guido Mariani



portafiori
vasche
lampade

porte-fleurs
vases
lampes

vases
and lamps

bucaros
jardineras
lamparas

blumenvasen
schalen
lampen



P 5 041/20 ●
cm ±20x11,±12

T 5 043/20 ●
cm ±20x11,±07

P 9 015/20
cm ±20x10,±10,5

T 9 017/20
cm ±20x10,±05

P 5 045/19 ●
cm ±19x17,±11,5

T 5 047/19 ●
cm ±19x17,±13x7



P 19 024/09
cm 9x12

P 19 024/11
cm 11x15



P 21 025/09
cm 9x12

P 21 025/10
cm 10x15

P 21 025/11
cm 11x15

portafiori
vasche
lampade

porte-fleurs
vases
lampes

vases
and lamps

bucaros
jardineras
lamparas

blumenvasen
schalen
lampen



CELLINI DECORATA

Designed by Gianluca Ugoletti - Guido Mariani



P 5 060/20 ⓘ
cm ±20x11,±12

P 5 064/19 ⓘ
cm ±19x17,±11,5

P 9 013/20
cm ±20x10,±10,5



P 19 022/09
cm 9x12

P 19 022/11
cm 11x15



P 21 023/09
cm 9x12

P 21 023/10
cm 10x15

P 21 023/11
cm 11x15



portafiori
vasche
lampade

porte-fleurs
vases
lampes

vases
and lamps

bucaros
jardineras
lamparas

blumenvasen
schalen
lampen



P 1 110/20
cm ±20x13,5,±14

I 1 111/20
cm ±20x13,5,±8,5x9,5

P 7 110/20
cm ±20x9,5,±9

I 7 111/20
cm ±20x9,5,±6,5

P 1 112/18
cm ±20x19,±14

I 1 113/18
cm ±20x19,±12x6



P 24 500/15 cm ±15x6

P 24 500/20 cm ±20x7,5

P 24 500/25 cm ±25x9,5



P 19 042/09 cm 9x12

P 19 042/11 cm 11x15



P 21 054/09 cm 9x12

P 21 054/11 cm 11x15

portafiori
vasche
lampade

porte-fleurs
vases
lampes

vases
and lamps

bucaros
jardineras
lamparas

blumenvasen
schalen
lampen



COMPOSIZIONI ARTISTICHE



Vasca

P 5 146/28
cm :28,5x27,5,~10



Lampada elettrica

P 7 101/23
cm :23,5x26,5,~9



Lampada elettrica

P 7 060/18
cm :18x10,~10



Lampada elettrica

P 7 103/34
cm :34x23,~7



Vasca

P 5 140/23
cm :23,5x26,~10



P 14 290/09 ● Cornice cm 9x12

P 14 290/11 ● Cornice cm 11x15

cm ±50x64±14
Cornice inclinabile e chiusa sul retro

Specificare al momento
dell'ordine il carattere desiderato:
Corsivo, Bastone o Romano.
L'incisione è compresa nel prezzo.



P 14 130/09 • Cornice cm 9x12

P 14 130/11 • Cornice cm 11x15

cm 45x65,7x14
Cornice inclinabile e chiusa sul retro

Specificare al momento
dell'ordine il carattere desiderato:
Corsivo, Bastone o Romano.
L'incisione è compresa nel prezzo.

SHELL MOULDING



SPIGA

Designed by Gianluca Ugoletti



portafiori
vasche
lampade

porte-fleurs
vases
lampes

vases
and lamps

bucaros
jardineras
lamparas

blumenvasen
schalen
lampen



P 5 101/20
cm ±20x11,↔11,5

I 5 112/20
cm ±20x11,↔ø5



P 7 301/20
cm ±20x8,5,↔9,5

I 7 312/20
cm ±20x8,5,↔ø4



P 5 103/17
cm ±17x17,↔12

I 5 114/17
cm ±17x17,↔11x5,5



P 19 003/06 cm 6x8

P 19 003/07 cm 7x9

P 19 003/08 cm 8x10

P 19 003/09 cm 9x12

P 19 003/11 cm 11x15

P 19 003/13 cm 13x18



P 21 007/09 cm 9x12

P 21 007/10 cm 10x15

P 21 007/11 cm 11x15

P 21 007/13 cm 13x18



I 19 017/09 cm 9x12

I 19 017/11 cm 11x15



I 21 034/09 cm 9x12

I 21 034/10 cm 10x15

I 21 034/11 cm 11x15

portafiori
vasche
lampade

porte-fleurs
vases
lampes

vases
and lamps

bucaros
jardineras
lamparas

blumenvasen
schalen
lampen



SPIGA

CINERARI E OSSARI



P 7 301/15
cm :15x6,7



P 5 101/12
cm :12,5x5,76



P 10 007/20
cm :20x12,712
T 10 016/20
cm :20x12,7ø8



P 4 001/17
cm :17x33,713



T 7 312/25
cm :25x12,7ø6



T 13 512/22
cm :22x11,7ø7,5



T 13 003/12
cm :12x16



T 5 112/29
cm :29x16,7ø8



T 12 011/23
cm :23x32,5,7ø17

ELIOS

Designed by Gianluca Ugoletti



portafiori
vasche
lampade

porte-fleurs
vases
lampes

vases
and lamps

bucaros
jardineras
lamparas

blumenvasen
schalen
lampen



P 5 105/20
cm :20x11,↗11,5

T 5 116/20
cm :20x11,↗ø5



P 7 303/20
cm :20x8,5,↗9,5

T 7 314/20
cm :20x8,5,↗ø4



P 5 124/17
cm :17x17,↗12

T 5 136/17
cm :17x17,↗11x5,5



P 10 023/20
cm :20x12,↗12

T 10 031/20
cm :20x12,↗ø8



T 7 314/25
cm :25x12,↗ø6



T 5 116/29
cm :29x16,↗ø8

portafiori
vasche
lampade

porte-fleurs
vases
lampes

vases
and lamps

bucaros
jardineras
lamparas

blumenvasen
schalen
lampen



FOGLIE D'AUTUNNO

Designed by Alessandro Asti



P 5 178/20
cm ±20x12,±11,5

T 5 189/20
cm ±20x12,±ø5



P 7 038/20
cm ±20x9,±8,5

T 7 078/20
cm ±20x9,±ø4,5



P 5 126/17
cm ±17x17,±11

T 5 138/17
cm ±17x17,±10,5x4,5



P 19 050/09 cm 9x12

P 19 050/11 cm 11x15



P 21 035/09 cm 9x12

P 21 035/11 cm 11x15

FENICE

BRONZO PATINA A CERA

Designed by Alessandro Asti



portafiori
vasche
lampade

porte-fleurs
vases
lampes

vases
and lamps

bucaros
jardineras
lamparas

blumenvasen
schalen
lampen



P 1 034/20R
cm ±20x12,±11,5

T 1 100/20R
cm ±20x12,±5x6

T 1 100/25R
cm ±25x15,±ø7

P 7 138/20
cm ±20x10,±9,5

T 7 182/20
cm ±20x10,±4,5x6

P 1 215/18R
cm ±18,5x18,±10,5

T 1 280/18R
cm ±18,5x18,±10,5x4,5

CINERARI E OSSARI



P 19 021/08
cm 8x10



P 21 004/09
cm 9x12



T 13 107/7
cm ±7,±ø13,5



P 10 050/20
cm ±20x12,±12



P 7 138/15
cm ±16x7,±7



P 1 034/13P
cm ±13x7,5,±7,5



P 1 215/09P
cm ±10x11,±7

P 19 021/09
cm 9x12

P 21 004/11
cm 11x15

T 10 065/20
cm ±20x12,±ø8

P 19 021/11
cm 11x15

portafiori
vasche
lampade

porte-fleurs
vases
lampes

vases
and lamps

bucaros
jardineras
lamparas

blumenvasen
schalen
lampen



FENICE

PATINA A CERA VERDE POMPEIANO

Designed by Alessandro Asti



P 1 143/20R
cm 20x12,2x11,5

I 1 185/20R
cm 20x12,2x5x6

I 1 185/25R
cm 25x15,2xø7



P 7 204/20
cm 20x10,2x9,5

I 7 238/20
cm 20x10,2x4,5x6



P 1 260/18R
cm 18,5x18,2x10,5

I 1 298/18R
cm 18,5x18,2x10,5x4,5



P 19 106/09
cm 9x12

P 19 106/11
cm 11x15



P 21 305/09
cm 9x12

P 21 305/11
cm 11x15



P 10 084/20
cm 20x12,2x12

I 10 101/20
cm 20x12,2xø8

FENICE

TERRA ANTICA PATINA A CERA

Designed by Alessandro Asti



portafiori
vasche
lampade

porte-fleurs
vases
lampes

vases
and lamps

bucaros
jardineras
lamparas

blumenvasen
schalen
lampen



P 1 042/20R
cm ±20x12,±11,5

T 1 121/20R
cm ±20x12,±5x6

T 1 121/25R
cm ±25x15,±ø7

P 7 147/20
cm ±20x10,±9,5

T 7 195/20
cm ±20x10,±4,5x6

P 1 227/18R
cm ±18,5x18,±10,5

T 1 285/18R
cm ±18,5x18,±10,5x4,5



P 19 032/09
cm 9x12

P 19 032/11
cm 11x15



P 21 044/09
cm 9x12

P 21 044/11
cm 11x15



P 10 121/20
cm ±20x12,±12

T 10 135/20
cm ±20x12,±ø8

portafiori
vasche
lampade

porte-fleurs
vases
lampes

vases
and lamps

bucaros
jardineras
lamparas

blumenvasen
schalen
lampen



FENICE

PATINA A CERA BLU

Designed by Alessandro Asti



P 1 020/20R ●
cm ±20x12,±11,5



P 7 155/20
cm ±20x10,±9,5



P 1 219/18R ●
cm ±18,5x18,±10,5



P 19 045/09
cm 9x12

P 19 045/11
cm 11x15



P 21 050/09
cm 9x12

P 21 050/11
cm 11x15



P 24 510/15
cm ±15x6

P 24 510/20
cm ±20x7,5

P 24 510/25
cm ±25x9,5



P 30 035/25
cm ±25x10

ONDINA



portafiori
vasche
lampade

porte-fleurs
vases
lampes

vases
and lamps

bucaros
jardineras
lamparas

blumenvasen
schalen
lampen



P 1 539/20R
cm ±20,5x13,5,±13,5

I 1 570/20R
cm ±20,5x13,5,±ø8

I 1 570/30R
cm ±30x19,±10x11,5

P 7 140/20
cm ±20x10,5,±11

I 7 180/20
cm ±20x10,5,±ø6

I 7 180/26
cm ±26x11,5,±ø9

P 1 980/19R
cm ±19,5x21,±14

I 2 030/19R
cm ±19,5x21,±12x7,5



P 19 820/09
cm 9x12

P 19 820/11
cm 11x15



P 21 620/09
cm 9x12

P 21 620/10
cm 10x15



P 23 200/25
cm ±25x14



P 10 160/19
cm ±19x14,5,±12,5

I 10 180/19
cm ±19x14,5,±ø8

portafiori
vasche
lampade

porte-fleurs
vases
lampes

vases
and lamps

bucaras
jardineras
lamparas

blumenvasen
schalen
lampen



ONDINA

PATINA A CERA VERDE POMPEIANO



P 1 560/20R
cm ±20,5x13,5,±13,5

T 1 620/20R
cm ±20,5x13,5,±08

T 1 620/30R
cm ±30x19,±10x11,5

P 7 150/20
cm ±20x10,5,±11

T 7 230/20
cm ±20x10,5,±06

T 7 230/26
cm ±26x11,5,±09

P 2 020/19R
cm ±19,5x21,±14

T 2 060/19R
cm ±19,5x21,±12x7,5



P 19 365/09
cm 9x12

P 19 365/11
cm 11x15



P 21 228/09
cm 9x12

P 21 228/10
cm 10x15



P 23 210/25
cm ±25x14



P 23 300/25
cm ±25x14



P 10 200/19
cm ±19x14,5,±12,5

T 10 220/19
cm ±19x14,5,±08

NILO

Designed by Alberto Nodolini



portafiori
vasche
lampade

porte-fleurs
vases
lampes

vases
and lamps

bucaros
jardineras
lamparas

blumenvasen
schalen
lampen



P 6 972/20
cm ±20x13,5,±13

T 6 983/20
cm ±20x13,5,±106,5

P 6 975/17
cm ±17x19,±13

T 6 986/17
cm ±17x19,±11,5x6,5

P 9 986/19
cm ±18,5x11,±10,5

T 9 998/19
cm ±19x11,±104,5



P 19 011/09 cm 9x12

P 19 011/11 cm 11x15

P 19 011/13 cm 13x18



P 21 001/09 cm 9x12

P 21 001/10 cm 10x15

P 21 001/11 cm 11x15

P 21 001/13 cm 13x18



T 19 007/09 cm 9x12

T 19 007/11 cm 11x15



T 21 014/09 cm 9x12

T 21 014/10 cm 10x15

T 21 014/11 cm 11x15

portafiori
vasche
lampade

porte-fleurs
vases
lampes

vases
and lamps

bucaros
jardineras
lamparas

blumenvasen
schalen
lampen



NILO

CINERARI E OSSARI



P 9 986/13
cm :13,5x7,5x7,5



P 6 972/12 ●
cm :12x8,7x7,5



P 10 303/18
cm :18x14,7x12,5

T 10 316/18
cm :18x14,7x7



P 6 978/17 ●
cm :17x33,7x13,5



T 9 998/25
cm :25,5x13,7x14,5



T 10 316/24
cm :24x19,7x18,5



T 6 983/30 ●
cm :30x19,7x19,5

NILO CLASSIC

Designed by Alberto Nodolini



portafiori
vasche
lampade

porte-fleurs
vases
lampes

vases
and lamps

bucaros
jardineras
lamparas

blumenvasen
schalen
lampen



P 6 954/20 ◐
cm ±20x13,5,±13

T 6 965/20 ◐
cm ±20x13,5,±ø6,5

P 9 988/19
cm ±18,5x11,±10,5

T 9 996/19
cm ±19x11,±ø4,5

P 6 957/17 ◐
cm ±17x19,±13

T 6 968/17 ◐
cm ±17x19,±11,5x6,5



P 19 013/09 cm 9x12

P 19 013/11 cm 11x15

P 19 013/13 cm 13x18



P 21 003/09 cm 9x12

P 21 003/10 cm 10x15

P 21 003/11 cm 11x15

P 21 003/13 cm 13x18

portafiori
vasche
lampade

porte-fleurs
vases
lampes

vases
and lamps

bucaros
jardineras
lamparas

blumenvasen
schalen
lampen



NILO
CLASSIC



Cristo

P 31 672/13 cm ±13x9
P 31 672/18 cm ±18x12,5



Pietà

P 31 688/14 cm ±14x12,5
P 31 688/18 cm ±18x16,5



Madonna

P 31 661/13 cm ±13x10
P 31 661/18 cm ±18x13



P 23 296/12 cm ±12x6,5
P 23 296/15 cm ±15x8
P 23 296/20 cm ±20x10



P 10 305/18
cm ±18x14,±12,5
I 10 318/18
cm ±18x14,±ø7

CLAUDIA

Designed by Vittorio Asti



portafiori
vasche
lampade

porte-fleurs
vases
lampes

vases
and lamps

bucaros
jardineras
lamparas

blumenvasen
schalen
lampen



P 2 195/19 
cm ±19x11,5,±10,5

I 2 207/19 
cm ±19x11,5,±ø7



P 7 852/17
cm ±17x10,±9

I 7 863/17
cm ±17x10,±7,5x5,5



P 2 173/16 
cm ±16x18,5,±11,5,±15x10
Predisposta anche per
l'applicazione a terreno



P 23 316/15 cm ±15x7,5

P 23 316/20 cm ±19,5x9,5

P 23 316/28 cm ±28x14,5

P 23 316/35 cm ±35x15

P 23 316/50 cm ±50x24



P 19 195/09 cm 9x12

P 19 195/11 cm 11x15

portafiori
vasche
lampade

porte-fleurs
vases
lampes

vases
and lamps

bucaros
jardineras
lamparas

blumenvasen
schalen
lampen



CLAUDIA



P 7 839/19
cm :19x16,↔9



P 2 218/15 
cm :16x32,↔11,↔28x9
Predisposta anche per
l'applicazione a terreno



T 10 925/23
cm :23x17,↔ø11,5



P 10 231/21
cm :21x16,↔11,5

T 10 242/21
cm :21x16,↔11x9



T 9 147/24
cm :24,5x14,↔ø11



T 4 745/30 
cm :30x17,↔12x11

OLIMPIA

Designed by Gianluca Ugoletti



portafiori
vasche
lampade

porte-fleurs
vases
lampes

vases
and lamps

bucaros
jardineras
lamparas

blumenvasen
schalen
lampen



P 2 181/19
cm ±19x13,±12
T 2 223/19
cm ±19x13,±5x4

P 2 595/18
cm ±18x18,5,±12
T 2 792/18
cm ±18x18,5,±7x3,5

P 9 515/20
cm ±20x11,±9,5
T 9 526/20
cm ±20x11,±ø4x3,5



P 10 912/18
cm ±18x14,±12,5
T 10 933/18
cm ±18x14,±ø7



T 9 526/27
cm ±27x13,±5x4,5



T 10 933/24
cm ±24x19,±ø8,5



T 2 223/29
cm ±29x17,±7,5x6

portafiori
vasche
lampade

porte-fleurs
vases
lampes

vases
and lamps

bucaros
jardineras
lamparas

blumenvasen
schalen
lampen



METEORA

Designed by Vittorio Asti



P 5 176/19
cm ±19x11,±12,5

T 5 187/19
cm ±19x11,±ø8



P 9 579/19
cm ±19x10,5,±8,5



P 5 198/18
cm ±17,5x18,±11



P 11 892/17
cm ±17,5x12,±11,5

T 11 904/17
cm ±17,5x12,±ø8



P 9 557/19
cm ±18,5x8,5,±9

T 9 568/19
cm ±18,5x8,5,±ø5,5

T 9 568/26
cm ±26x10,5,±ø6,5



T 11 243/24
cm ±24,5x15,±ø10



T 5 187/29
cm ±29x15,±ø9

SELENE

Designed by Gianluca Ugoletti



portafiori
vasche
lampade

porte-fleurs
vases
lampes

vases
and lamps

bucaros
jardineras
lamparas

blumenvasen
schalen
lampen

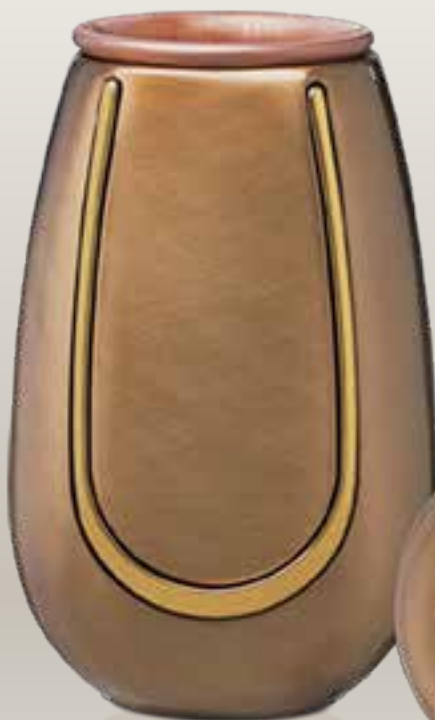

P 4 211/20
cm ±19,5x12,5↔10,5

I 4 222/20
cm ±20x12,5↔7x5,5



P 9 251/19
cm ±19,5x11↔8

I 9 262/20
cm ±20x11↔6x3,5



P 4 233/17
cm ±17x19↔9,5

I 4 244/17
cm ±17,5x19↔8x4



P 9 295/17
cm ±17x16,5↔8

I 9 227/17
cm ±17,5x16,5↔6x3



P 11 892/17
cm ±17,5x12↔11,5

I 11 904/17
cm ±17,5x12↔8



P 9 216/17
cm ±17x16,5↔8

I 9 227/17
cm ±17,5x16,5↔6x3

portafiori
vasche
lampade

porte-fleurs
vases
lampes

vases
and lamps

bucaros
jardineras
lamparas

blumenvasen
schalen
lampen



STELLA

Designed by Vittorio Asti



P 5 655/20
cm ±20x14,±11,5



P 9 672/19
cm ±19x10,5,±8,5



P 5 611/17
cm ±17,5x19,5,±10



P 24 237/15
cm ±15x7

P 24 237/20
cm ±20x8,5

P 24 237/25
cm ±25x11

P 24 237/30
cm ±30x13

P 24 237/40
cm ±40x16
con fregio
dorato



P 19 537/09 cm 9x12

P 19 537/11 cm 11x15

P 19 537/13 cm 13x18



P 21 473/09 cm 9x12

P 21 473/10 cm 10x15

P 21 473/11 cm 11x15

P 21 473/13 cm 13x18

PERLA

Designed by Vittorio Asti



portafiori
vasche
lampade

porte-fleurs
vases
lampes

vases
and lamps

bucaros
jardineras
lamparas

blumenvasen
schalen
lampen



P 4 756/18
cm ±17,5x9,±10

P 4 756/22
cm ±22,5x12,±12

I 4 767/18
cm ±17,5x9,±ø5

I 4 767/22
cm ±22,5x12,±ø6

P 9 002/16
cm ±19x9,5,±9

I 9 011/16
cm ±19x9,5,±2,5x4

P 2 107/17
cm ±17,5x17,±11,5

I 2 118/17
cm ±17,5x17,±8x4,5



I 10 307/18
cm ±18x14,±12,5

I 10 320/18
cm ±18x14,±ø7
Patina chiara



P 9 158/16
cm ±16x8,5,±10

P 9 158/18
cm ±17,5x11,±12

I 9 169/18
cm ±17,5x11,±ø6

I 9 169/21
cm ±22x13,±ø7



I 10 320/24
cm ±24x19,±ø8,5
Patina chiara



I 4 767/28
cm ±27,5x14,±ø6,5

portafiori
vasche
lampade

porte-fleurs
vases
lampes

vases
and lamps

bucaros
jardineras
lamparas

blumenvasen
schalen
lampen



TULIPANO

Designed by Alessandro Asti



P 4 552/20
cm ±19,5x10,±11

T 4 563/20
cm ±19,5x10,±05

T 4 563/24
cm ±25,5x11,5,±06

T 4 563/30
cm ±30,5x14,±08

T 4 563/38
cm ±37,5x17,±09,5

T 4 563/50
cm ±50x22,5,±012,5



P 9 056/18
cm ±18x9,5,±10

T 9 067/18
cm ±18x9,5,±05



P 4 574/18
cm ±19x15,5,±11

T 4 585/18
cm ±19x15,5,±11x4,5



P 10 754/18
cm ±18x11,5,±11,5



P 12 038/09
cm ±9x9,5,±10

T 12 049/09
cm ±9x9,5,±05



T 12 049/20
cm ±20x18,5,±011



T 9 067/24
cm ±24,5x11,5,±06,5



T 10 801/24
cm ±24,5x15,±010



T 4 608/55
cm ±55x22,5,±023

T 10 765/18
cm ±18x11,5,±08

P 12 038/10
cm ±11x12,±12,5

T 12 049/10
cm ±11x12,±06,5

TULIPANO

Designed by Alessandro Asti



portafiori
vasche
lampade

porte-fleurs
vases
lampes

vases
and lamps

bucaros
jardineras
lamparas

blumenvasen
schalen
lampen



P 4 676/20 ◉
cm :19,5x10,↔11

I 4 687/20 ◉
cm :19,5x10,↔ø5



P 9 091/18
cm :18x9,5,↔10

I 9 103/18
cm :18x9,5,↔ø5



P 10 754/18
cm :18x11,5,↔11,5

I 10 765/18
cm :18x11,5,↔ø8



I 9 103/24
cm :24,5x11,5,↔ø6,5



I 10 801/24
cm :24,5x15,↔ø10



I 4 687/30 ◉
cm :30,5x14,↔ø8

portafiori
vasche
lampade

porte-fleurs
vases
lampes

vases
and lamps

bucaros
jardineras
lamparas

blumenvasen
schalen
lampen



TULIPANO

Designed by Alessandro Asti



P 4 619/20
cm ±19,5x10,±11

T 4 621/20
cm ±19,5x10,±05

T 4 621/30
cm ±30,5x14,±08

T 4 621/38
cm ±37,5x17,±09,5

T 4 621/50
cm ±50x22,5,±12,5



P 9 078/18
cm ±18x9,5,±10

T 9 089/18
cm ±18x9,5,±05



P 4 632/18
cm ±19x15,5,±11

T 4 643/18
cm ±19x15,5,±11x4,5



P 10 754/18
cm ±18x11,5,±11,5

T 10 765/18
cm ±18x11,5,±08



T 9 089/24
cm ±24,5x11,5,±06,5



T 10 801/24
cm ±24,5x15,±010



T 4 665/55
cm ±55x22,5,±023

GALASSIA

Designed by Vittorio Asti



portafiori
vasche
lampade

porte-fleurs
vases
lampes

vases
and lamps

bucaros
jardineras
lamparas

blumenvasen
schalen
lampen



P 2 311/19 ⓘ
cm ±19x11,±11,5



P 7 896/18
cm ±18x16,±9,5



P 2 297/17 ⓘ
cm ±17x23,±12,5



P 19 116/09 cm 9x12
P 19 116/11 cm 11x15
P 19 116/13 cm 13x18



P 2 333/17 ⓘ
cm ±16,5x37,±13

portafiori
vasche
lampade

porte-fleurs
vases
lampes

vases
and lamps

bucaros
jardineras
lamparas

blumenvasen
schalen
lampen



ORO

Designed by Vittorio Asti



P 1 319/20 ⓘ
cm :20x9,5,2-10,5



P 7 214/18
cm :18x8,5,2-10



P 1 252/16 ⓘ
cm :16,5x15,5,2-9,5



P 19 218/09
cm 9x12

P 19 218/11
cm 11x15



P 21 132/09
cm 9x12

P 21 132/10
cm 10x15

P 21 132/11
cm 11x15

DRAPPO



portafiori
vasche
lampade

porte-fleurs
vases
lampes

vases
and lamps

bucaros
jardineras
lamparas

blumenvasen
schalen
lampen



P 6 645/19 ◉
cm ±19x9,±9,5

I 6 656/19 ◉
cm ±19x9,±ø5,5



P 9 353/20
cm ±20x8,5,±8,5

I 9 364/20
cm ±20x8,5,±ø4,5



P 10 492/15
cm ±15x10,±10,5

I 10 504/15
cm ±15x10,±ø6



P 24 897/17
cm ±17x9



P 19 823/07
cm 7x9

P 19 823/09
cm 9x12

P 19 823/11
cm 11x15

P 19 823/13
cm 13x18

P 19 823/18
cm 18x24



P 9 353/24
cm ±24,5x10,±10,5

I 9 364/24
cm ±24,5x10,±ø5,5



P 6 645/23 ◉
cm ±23x11,±11,5

I 6 656/23 ◉
cm ±23x11,±ø7



P 10 492/19
cm ±19x12,±11

I 10 504/19
cm ±19x12,±ø7,5



portafiori
vasche
lampade

porte-fleurs
vases
lampes

vases
and lamps

bucaros
jardineras
lamparas

blumenvasen
schalen
lampen



PERGAMENA



P 6 485/20 ⓘ
cm ±20x12,↗9
I 6 496/20 ⓘ
cm ±20x12,↗5x6



P 9 865/20
cm ±21,5x10,5,↗8,5
I 9 876/20
cm ±21,5x10,5,↗5,5x5



P 23 247/18
cm ±18x10



P 19 834/09 cm 9x12
P 19 834/11 cm 11x15



P 9 887/21
cm ±21x12,5,↗8,5



P 2 812/16 ⓘ
cm ±16x20,↗10



P 7 293/19
cm ±18x9,↗7



P 1 412/20 ⓘ
cm ±20x12,↗8



P 7 759/19
cm ±19x9,↗9,5



P 1 979/20 ⓘ
cm ±20,5x9,5,↗11



I 5 861/27 ⓘ
cm ±27x15,↗10,5x10,5



I 10 567/24
cm ±24,5x15,↗8,5x8,5



I 9 808/26
cm ±26,5x15,5,↗ø6,5



I 6 428/30 ⓘ
cm ±30,5x23,↗ø8,5



I 5 381/29 ⓘ
cm ±29x15,5,↗ø9,5



I 10 082/22
cm ±22,5x12,5,↗8,5x8,5



PRESSOFUSIONE





portafiori
vasche
lampade

porte-fleurs
vases
lampes

vases
and lamps

bucaros
jardineras
lamparas

blumenvasen
schalen
lampen



OLMO

Designed by Alessandro Asti



P 1 019/20R
cm ±20x13,±11

I 1 037/20R
cm ±20x13,±6x5,5

P 7 004/19
cm ±19x11,±9,5

I 7 018/19
cm ±19x11,±5,5x4,5

P 2 050/18R
cm ±18x18,±12

I 2 065/18R
cm ±18x18,±6,5x12



P 24 160/15
cm 15x7



P 19 018/09
cm 9x12



P 21 005/09
cm 9x12



CINERARI E OSSARI



P 7 004/16
cm ±16x8,±7



P 1 019/13P
cm ±13x8,±7,5



P 21 051/08
cm 8x10



P 19 020/08
cm 8x10

P 24 160/20
cm 20x8,5

P 19 018/11
cm 11x15

P 21 005/11
cm 11x15

P 24 160/25
cm 25x11

OLMO VERDE POMPEIANO

Designed by Alessandro Asti



portafiori
vasche
lampade

porte-fleurs
vases
lampes

vases
and lamps

bucaros
jardineras
lamparas

blumenvasen
schalen
lampen



P 1 052/20R
cm ±20x13,±11

I 1 065/20R
cm ±20x13,±6x5,5

P 7 068/19
cm ±19x11,±9,5

I 7 116/19
cm ±19x11,±5,5x4,5

P 2 074/18R
cm ±18x18,±12

I 2 091/18R
cm ±18x18,±6,5x12

CINERARI E OSSARI



P 24 185/15
cm 15x7



P 19 029/09
cm 9x12



P 21 021/09
cm 9x12



P 7 068/16
cm ±16x8,±7



P 1 052/13P
cm ±13x8,±7,5



P 21 059/08
cm 8x10



P 19 054/08
cm 8x10

P 24 185/20
cm 20x8,5

P 19 029/11
cm 11x15

P 21 021/11
cm 11x15

P 24 185 /25
cm 25x11

portafiori
vasche
lampade

porte-fleurs
vases
lampes

vases
and lamps

bucaros
jardineras
lamparas

blumenvasen
schalen
lampen



OLMO CROMINOX

Designed by Alessandro Asti



P 1 087/20R
cm ±20x13,±11



P 7 154/19
cm ±19x11,±9,5



P 2 158/18R
cm ±18x18,±12



P 19 078/08
cm 8x10

P 19 078/09
cm 9x12

P 19 078/11
cm 11x15



P 21 112/08
cm 8x10

P 21 112/09
cm 9x12

P 21 112/10
cm 10x15

P 21 112/11
cm 11x15

CINERARI E OSSARI



P 7 154/16
cm ±16x8,±7



P 1 087/13P
cm ±13x8,±7,5



portafiori
vasche
lampade

porte-fleurs
vases
lampes

vases
and lamps

bucaros
jardineras
lamparas

blumenvasen
schalen
lampen



FIORE LINE



P 1 108/21P
cm ±21x11,5,±11,5

T 1 122/21P
cm ±21x11,5,±7,5x8

P 7 136/19
cm ±19x9,±8,5

T 7 148/19
cm ±19x9,±6x5

P 2 031/18P
cm ±18,5x19,±14

T 2 048/18P
cm ±18,5x19,±14x9



T 13 018/10P
cm ±10x16

Vaso incasso
interno H. cm 20



T 12 008/10R
cm ±10x16

Fioriera
interno H. cm 6



T 10 029/23
cm ±23x12,5



T 1 122/28P
cm ±28x15,±10x10,5

SEMIVASO



P 1 408/13
cm ±14x7,±4

P 1 408/21
cm ±21x11,5,±6

CINERARI E OSSARI



P 2 928/12P
cm ±12x4,5,±3,5

P 7 136/14
cm ±14x7,±7,5

P 1 108/13P
cm ±13x7,±7,5

ATHENEIA

Designed by Gianluca Ugoletti



portafiori
vasche
lampade

porte-fleurs
vases
lampes

vases
and lamps

bucaros
jardineras
lamparas

blumenvasen
schalen
lampen



P 5 314/18
cm ±18x9,5,±10

P 5 314/20
cm ±20x10,5,±11,5

T 5 325/18
cm ±18x9,5,±05

T 5 325/20
cm ±20x10,5,±06

P 9 535/18
cm ±18x8,5,±9

P 9 535/26
cm ±26x11,5,±12

T 9 546/18
cm ±18x8,5,±05

T 9 546/26
cm ±26x11,5,±06,5

P 5 336/16
cm ±17x16,±12

T 5 347/16
cm ±17x16,±11,5x6,5



P 19 537/09
cm 9x12

P 19 537/11
cm 11x15

P 19 537/13
cm 13x18



P 21 473/09
cm 9x12

P 21 473/10
cm 10x15

P 21 473/11
cm 11x15

P 21 473/13
cm 13x18



T 19 892/09
cm 9x12

T 19 892/11
cm 11x15

T 19 892/13
cm 13x18



T 21 651/09
cm 9x12

T 21 651/10
cm 10x15

T 21 651/11
cm 11x15

T 21 651/13
cm 13x18

portafiori
vasche
lampade

porte-fleurs
vases
lampes

vases
and lamps

bucaros
jardineras
lamparas

blumenvasen
schalen
lampen



ATHENEAE

CINERARI E OSSARI



P 9 535/15
cm :14,5x6,5,7

T 9 546/15
cm :14,5x6,5,ø3,5



P 5 314/13 ◉
cm :13x7,7,5

T 5 325/13 ◉
cm :13x7,ø3,5



P 11 892/17
cm :17,5x12,ø11,5

T 11 904/17
cm :17,5x12,ø8



P 5 358/16 ◉
cm :16,5x30,5,ø12,5



P 11 892/24
cm :26x15,ø18

T 11 904/24
cm :26x15,ø9



T 12 541/21 ◉
cm :20,5x30,ø22



P 5 314/26 ◉ cm :26x13,5,ø14

P 5 314/30 ◉ cm :30x14,ø15,5

T 5 325/26 ◉ cm :26x13,5,ø7,5

T 5 325/28 ◉ cm :28x14,ø8,5

T 5 325/35 ◉ cm :34,5x16,5,ø9

T 5 576/56 ◉ cm :56x26,5,ø14,5



T 13 746/21
cm :21x11,ø6,5



T 13 245/95 ◉
cm :9,5x16

GRAZIA

Designed by Gianluca Ugoletti



portafiori
vasche
lampade

porte-fleurs
vases
lampes

vases
and lamps

bucaros
jardineras
lamparas

blumenvasen
schalen
lampen



P 2 234/20R ◉
cm :20x11,5,↔12

T 2 244/20R ◉
cm :20x11,5,↔ø6,5

P 9 026/21
cm :21x10,↔10,5

T 9 037/21
cm :21x10,↔ø6

P 4 253/19R ◉
cm :19x17,5,↔11,5

T 4 262/19R ◉
cm :19x17,5,↔12x6



T 13 623/21
cm :21x12,↔ø9



T 12 811/12 ◉
cm :12x23,↔ø18,5



T 13 036/09R ◉
cm :9x16



T 12 112/12 ◉
cm :12x23

portafiori
vasche
lampade

porte-fleurs
vases
lampes

vases
and lamps

bucaros
jardineras
lamparas

blumenvasen
schalen
lampen



GRAZIA



P 10 584/18
cm :18x11,5x11

T 10 695/18
cm :18x11,5xø6,5

T 10 695/24
cm :24x16xø9,5



P 4 326/17R

cm :17x32,5x12,5



P 19 559/09 cm 9x12

P 19 559/11 cm 11x15

P 19 559/13 cm 13x18



P 21 451/09 cm 9x12

P 21 451/10 cm 10x15

P 21 451/11 cm 11x15

P 21 451/13 cm 13x18



T 19 602/09 cm 9x12

T 19 602/11 cm 11x15

T 19 602/13 cm 13x18

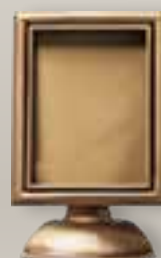

T 21 646/09 cm 9x12

T 21 646/10 cm 10x15

T 21 646/11 cm 11x15

T 21 646/13 cm 13x18



T 9 037/27
cm :27x12,5xø7,5



T 2 244/30R

cm :30x16,5xø10



T 10 695/24
cm :24x16xø9,5

GRAZIA

ORO

Designed by Gianluca Ugoletti



portafiori
vasche
lampade

porte-fleurs
vases
lampes

vases
and lamps

bucaros
jardineras
lamparas

blumenvasen
schalen
lampen



P 2 236/20R ◉
cm :20x11,5,→12

T 2 245/20R ◉
cm :20x11,5,→ø6,5

P 9 028/21
cm :21x10,→10,5

T 9 042/21
cm :21x10,→ø6

P 4 251/19R ◉
cm :19x17,5,→11,5

T 4 263/19R ◉
cm :19x17,5,→12x6



T 13 625/21
cm :21x12,→ø9



T 12 812/12 ◉
cm :12x23,→ø18,5



T 13 031/09R ◉
cm :9x16



T 12 111/12 ◉
cm :12x23

portafiori
vasche
lampade

porte-fleurs
vases
lampes

vases
and lamps

bucaros
jardineras
lamparas

blumenvasen
schalen
lampen



GRAZIA ORO



P 10 581/18
cm ±18x11,5x11

T 10 692/18
cm ±18x11,5xø6,5



P 4 328/17R ⓘ
cm ±17x32,5x12,5



P 19 537/09 cm 9x12
P 19 537/11 cm 11x15
P 19 537/13 cm 13x18



P 21 473/09 cm 9x12
P 21 473/10 cm 10x15
P 21 473/11 cm 11x15
P 21 473/13 cm 13x18



T 19 892/09 cm 9x12
T 19 892/11 cm 11x15
T 19 892/13 cm 13x18



T 21 651/09 cm 9x12
T 21 651/10 cm 10x15
T 21 651/11 cm 11x15
T 21 651/13 cm 13x18



T 9 042/27
cm ±27x12,5xø7,5



T 2 245/30R ⓘ
cm ±30x16,5xø10



T 10 692/24
cm ±24x16xø9,5

LUNA



portafiori
vasche
lampade

porte-fleurs
vases
lampes

vases
and lamps

bucaros
jardineras
lamparas

blumenvasen
schalen
lampen



P 1 170/20R
cm ±20x12,±11,5

T 1 180/20R
cm ±20x12,±7

P 1 196/20R
cm ±19,5x19,±11,5

T 1 200/20R
cm ±19,5x19,±10,5x6,5



P 7 190/20
cm ±19,5x9,5,±9

T 7 100/20
cm ±19,5x9,5,±5



P 19 660/09 cm 9x12
P 19 660/11 cm 11x15



P 21 500/09 cm 9x12
P 21 500/10 cm 10x15

portafiori
vasche
lampade

porte-fleurs
vases
lampes

vases
and lamps

bucaros
jardineras
lamparas

blumenvasen
schalen
lampen



LUNA

CINERARI E OSSARI



P 7 190/13
cm ±13x7,±6
T 7 100/13
cm ±13x7,±ø4



P 1 170/13R Ⓛ
cm ±13x8,±7,5
T 1 180/13R Ⓛ
cm ±13x8,±ø4,5



P 10 085/12
cm ±11,5x9,5,±8,5
T 10 090/12
cm ±11,5x9,5,±ø6



T 13 055/07P Ⓛ
cm ±7,±24x22



T 13 065/25
cm ±24,5,±24x22



P 10 085/20
cm ±19,5x11,±13
T 10 090/20
cm ±19,5x11,±6,5x8,5



T 7 100/25
cm ±25x11,±ø8



T 10 090/23
cm ±22,5x15,±7,5x9,5



T 1 180/30R Ⓛ
cm ±30,5x17,±ø9

AQUA



portafiori
vasche
lampade

porte-fleurs
vases
lampes

vases
and lamps

bucaros
jardineras
lamparas

blumenvasen
schalen
lampen



P 1 045/20R
cm ±20,5x13,±12

I 1 050/20R
cm ±20,5x13,±07



P 7 205/20
cm ±20x9,±8

I 7 300/20
cm ±20x9,±5x5,5



P 1 060/20R
cm ±20x19,±12

I 1 070/20R
cm ±20x19,±10,5x7



P 10 030/20
cm ±19,5x12,±12

I 10 040/20
cm ±19,5x12,±7,5x9



I 7 300/25
cm ±25x15,±7x9



I 10 040/25
cm ±24,5x15,±8x9



I 1 050/30R
cm ±30x17,±9x10

portafiori
vasche
lampade

porte-fleurs
vases
lampes

vases
and lamps

bucaros
jardineras
lamparas

blumenvasen
schalen
lampen



SMIGLIA

Designed by Gianluca Ugoletti



P 1 128/20R ⓘ
cm ±19,5x11,5, ±10,5

I 1 127/20R ⓘ
cm ±19,5x11,5, ±6,5x6



P 7 050/20
cm ±20x10, ±9

I 7 062/20
cm ±20x10, ±6x5,5



P 1 129/19R ⓘ
cm ±18,5x17, ±11,5

I 1 130/19R ⓘ
cm ±18,5x17, ±11x7



I 1 127/29P ⓘ
cm ±29x14, ±9x8



I 10 829/24
cm ±24x13, ±8x8

CINERARI E OSSARI



P 7 050/15
cm ±15x7, ±7



P 1 128/13P ⓘ
cm ±13x7, ±7

VENUS

Designed by Gianluca Ugoletti



portafiori
vasche
lampade

porte-fleurs
vases
lampes

vases
and lamps

bucaros
jardineras
lamparas

blumenvasen
schalen
lampen



P 1 120/20R
cm ±19,5x11,5, ±10,5

I 1 125/20R
cm ±19,5x11,5, ±6,5x6



P 7 070/20
cm ±20x10, ±9

I 7 086/20
cm ±20x10, ±6x5,5



P 1 123/19R
cm ±18,5x17, ±11,5

I 1 135/19R
cm ±18,5x17, ±11x7

CINERARI E OSSARI



P 7 070/15
cm ±15x7, ±7



P 1 120/13P
cm ±13x7, ±7



P 19 101/09 cm 9x12

P 19 101/11 cm 11x15

P 19 101/13 cm 13x18



P 21 081/09 cm 9x12

P 21 081/10 cm 10x15

P 21 081/11 cm 11x15

P 21 081/13 cm 13x18

portafiori
vasche
lampade

porte-fleurs
vases
lampes

vases
and lamps

bucaros
jardineras
lamparas

blumenvasen
schalen
lampen



AURORA



P 1 420/20P
cm ±20x12,5x11

P 2 430/20P
cm ±20x20x11,5

P 8 380/21
cm ±21,5x9,5x8,5



P 19 559/09 cm 9x12
P 19 559/11 cm 11x15
P 19 559/13 cm 13x18



P 21 451/09 cm 9x12
P 21 451/10 cm 10x15
P 21 451/11 cm 11x15
P 21 451/13 cm 13x18



P 10 770/19
cm ±19,5x12x11

LE CANTARE



portafiori
vasche
lampade

porte-fleurs
vases
lampes

vases
and lamps

bucaras
jardineras
lamparas

blumenvasen
schalen
lampen



P 5 974/19R Ⓢ

P 5 974/19P Ⓢ
cm :19,5x11,5

T 5 985/19R Ⓢ

T 5 985/19P Ⓢ
cm :19,5x11,5

P 9 193/19

cm :19,5x9,9

T 9 205/19

cm :19,5x9,5

P 4 893/18R Ⓢ

P 4 893/18P Ⓢ
cm :18,5x17,5

T 4 905/18R Ⓢ

T 4 905/18P Ⓢ
cm :18,5x17,5



P 10 307/18

cm :18x14,5

T 10 320/18

cm :18x14,5

Patina chiara

T 9 205/25

cm :27x11,5

T 5 985/30R Ⓢ

cm :29x18,5

T 5 985/30P Ⓢ

cm :29x18,5

T 11 447/24

cm :24,5x18,5

portafiori
vasche
lampade

porte-fleurs
vases
lampes

vases
and lamps

bucaros
jardineras
lamparas

blumenvasen
schalen
lampen



LE CANTARE CLASSIC



P 5 976/19
cm ±19,5x11,±11,5

T 5 987/19
cm ±19,5x11,±ø8



P 9 196/19
cm ±19,5x9,±9

T 9 207/19
cm ±19,5x9,±ø4,5



P 4 896/18
cm ±18,5x17,±11,5

T 4 907/18
cm ±18,5x17,±ø9,5x5



P 10 305/18
cm ±18x14,±12,5

T 10 318/18
cm ±18x14,±ø7



T 9 207/25
cm ±27x11,5,±ø6



T 5 987/30
cm ±29x18,±ø13



T 10 318/24
cm ±24x19,±ø8,5

DANUBIO

Designed by Gianluca Ugoletti



portafiori
vasche
lampade

porte-fleurs
vases
lampes

vases
and lamps

bucaros
jardineras
lamparas

blumenvasen
schalen
lampen



P 2 140/18R Ⓡ

P 2 140/18P Ⓡ
cm ±18,5x11,±10

P 2 140/20R Ⓡ

P 2 140/20P Ⓡ
cm ±20x13,±12

T 2 142/18R Ⓡ

T 2 142/18P Ⓡ
cm ±18,5x11,±6x5

T 2 142/20R Ⓡ

T 2 142/20P Ⓡ
cm ±20x13,±6,5

P 7 240/21
cm ±21x10,±9

T 7 242/21
cm ±21x10,±6,5

P 2 146/19R Ⓡ

P 2 146/19P Ⓡ
cm ±19x18,5,±11,5

T 2 148/19R Ⓡ

T 2 148/19P Ⓡ
cm ±19x18,5,±12x6



T 13 511/12
cm ±12,±18,5



T 13 422/11R Ⓡ
T 13 422/11P Ⓡ
cm ±11x17

portafiori
vasche
lampade

porte-fleurs
vases
lampes

vases
and lamps

bucaros
jardineras
lamparas

blumenvasen
schalen
lampen



DANUBIO

CINERARI E OSSARI



P 7 240/15
cm ±15x7,±6,5

T 7 242/15
cm ±15x7,±4x3,5



P 2 140/13R

cm ±13x8,±7,5

P 2 140/13P

cm ±13x8,±7,5

T 2 142/13R

cm ±13x8,±4,5x3,5



P 19 101/09
cm 9x12

P 19 101/11
cm 11x15

P 19 101/13
cm 13x18



P 21 081/09
cm 9x12

P 21 081/10
cm 10x15

P 21 081/11
cm 11x15

P 21 081/13
cm 13x18



T 19 181/09
cm 9x12

T 19 181/11
cm 11x15



T 21 161/09
cm 9x12

T 21 161/10
cm 10x15

T 21 161/11
cm 11x15



P 10 561/19
cm ±19x12,±12,5

T 10 563/19
cm ±19x12,±7x7



T 7 242/27
cm ±26,5x12,5,±7x6



T 2 142/30R

T 2 142/30P

cm ±30x18,5,±9,5x8,5



T 10 563/24
cm ±24,5x15,±8,5x8,5

IBISCO

Designed by Gianluca Ugoletti



portafiori
vasche
lampade

porte-fleurs
vases
lampes

vases
and lamps

bucaros
jardineras
lamparas

blumenvasen
schalen
lampen



P 5 071/20R Ⓢ

P 5 071/20P Ⓢ
cm ±20x12,±13

T 5 092/20R Ⓢ

T 5 092/20P Ⓢ
cm ±20x12,±ø5,5

P 9 603/21
cm ±21x10,±10,5

T 9 692/21
cm ±21x10,±ø4,5

P 5 073/18R Ⓢ

P 5 073/18P Ⓢ
cm ±18x17,5,±12

T 5 094/18R Ⓢ

T 5 094/18P Ⓢ
cm ±18x17,5,±10,5x4,5



P 10 303/18
cm ±18x14,±12,5

T 10 316/18
cm ±18x14,±ø7

T 9 692/27
cm ±27x12,5,±ø6

T 5 092/29R Ⓢ

T 5 092/29P Ⓢ
cm ±29x17,5,±ø8

T 10 316/24
cm ±24x19,±ø8,5

portafiori
vasche
lampade

porte-fleurs
vases
lampes

vases
and lamps

bucaros
jardineras
lamparas

blumenvasen
schalen
lampen



FIOR DI LOTO

Designed by Enzo Naso



P 6 889/20R Ⓡ

P 6 889/20P Ⓡ
cm ±20x12,±11

T 6 892/20R Ⓡ

T 6 892/20P Ⓡ
cm ±20x12,±ø7

P 9 982/19
cm ±19x10,5,±8,5

T 9 994/19
cm ±19x10,5,±ø5,5

P 6 887/17R Ⓡ

P 6 887/17P Ⓡ
cm ±17x19,±12

T 6 894/17R Ⓡ

T 6 894/17P Ⓡ
cm ±17x19,±10x6,5



P 10 341/18
cm ±18x14,±12,5

T 10 352/18
cm ±18x14,±ø7



T 9 994/26
cm ±27x13,±ø7,5



T 6 892/30R Ⓡ
T 6 892/30P Ⓡ
cm ±29,5x16,5,±ø9,5



T 10 352/24
cm ±24x19,±ø8,5

ANTICA

Designed by Gianluca Ugoletti



portafiori
vasche
lampade

porte-fleurs
vases
lampes

vases
and lamps

bucaros
jardineras
lamparas

blumenvasen
schalen
lampen



P 2 347/20P ①
cm ±20x11,5,±12

T 2 401/20P ①
cm ±20x11,5,±ø6,5



P 9 123/21
cm ±21x10,±10,5

T 9 145/21
cm ±21x10,±ø6



P 4 355/19P ①
cm ±19x17,5,±11,5

T 4 361/19P ①
cm ±19x17,5,±12x6



P 19 101/09 cm 9x12

P 19 101/11 cm 11x15

P 19 101/13 cm 13x18



P 21 081/09 cm 9x12

P 21 081/10 cm 10x15

P 21 081/11 cm 11x15

P 21 081/13 cm 13x18



T 19 181/09 cm 9x12

T 19 181/11 cm 11x15



T 21 161/09 cm 9x12

T 21 161/10 cm 10x15

T 21 161/11 cm 11x15

portafiori
vasche
lampade

porte-fleurs
vases
lampes

vases
and lamps

bucaros
jardineras
lamparas

blumenvasen
schalen
lampen



ANTICA



P 10 485/18
cm ±18x11,5,±11

T 10 705/18
cm ±18x11,5,±ø6,5



P 4 424/17P ⓘ
cm ±17x32,5,±12,5

T 4 435/17P ⓘ
cm ±17x32,5,±28x8



T 13 634/21
cm ±21x12,±ø9



T 12 824/11 ⓘ
cm ±11x16,±ø11



T 12 833/12 ⓘ
cm ±12x23,±ø18,5



T 13 043/09R ⓘ
cm ±9x16



T 12 113/12 ⓘ
cm ±12x23

T 13 043/09P ⓘ
cm ±9x16



T 9 145/27
cm ±27x12,5,±ø7,5



T 2 401/30P ⓘ
cm ±30x16,5,±ø10



T 10 705/24
cm ±24x16,±ø9,5

ANTICA CLASSIC

Designed by Gianluca Ugoletti



portafiori
vasche
lampade

porte-fleurs
vases
lampes

vases
and lamps

bucaros
jardineras
lamparas

blumenvasen
schalen
lampen



P 2 341/20
cm ±20x11,5x12

T 2 403/20
cm ±20x11,5xø6,5

P 9 122/21
cm ±21x10x10,5

T 9 144/21
cm ±21x10xø6

P 4 354/19
cm ±19x17,5x11,5

T 4 366/19
cm ±19x17,5x12x6



P 23 296/12
cm ±12x6,5

P 23 296/15
cm ±15x8

P 23 296/20
cm ±20x10



P 19 790/09
cm 9x12

P 19 790/11
cm 11x15

P 19 790/13
cm 13x18

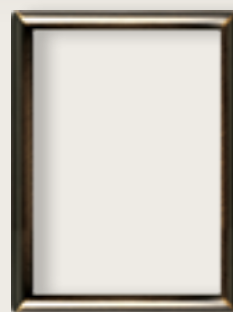

P 21 079/09
cm 9x12

P 21 079/10
cm 10x15

P 21 079/11
cm 11x15

P 21 079/13
cm 13x18

portafiori
vasche
lampade

porte-fleurs
vases
lampes

vases
and lamps

bucaros
jardineras
lamparas

blumenvasen
schalen
lampen



ANTICA CLASSIC



Cristo

P 31 672/13
cm ±13x9

P 31 672/18
cm ±18x12,5



Pietà

P 31 688/14
cm ±14x12,5

P 31 688/18
cm ±18x16,5



Madonna

P 31 661/13
cm ±13x10

P 31 661/18
cm ±18x13



T 13 636/21
cm ±21x12,5-ø9



T 12 831/12 ⓘ
cm ±12x23,5-ø18,5



T 13 046/09 ⓘ
cm ±9x16



T 12 118/12 ⓘ
cm ±12x23



P 10 483/18
cm ±18x11,5-ø11

T 10 702/18
cm ±18x11,5-ø6,5



T 9 144/27
cm ±27x12,5-ø7,5



T 2 403/30 ⓘ
cm ±30x16,5-ø10



T 10 702/24
cm ±24x16,5-ø9,5

LINDA



portafiori
vasche
lampade

porte-fleurs
vases
lampes

vases
and lamps

bucaros
jardineras
lamparas

blumenvasen
schalen
lampen



P 6 601/20R ①

P 6 601/20P ①
cm ±20x12,↔11

T 6 603/20R ①

T 6 603/20P ①
cm ±20x12,↔ø7

P 9 834/19
cm ±19x10,5,↔8,5

T 9 841/19
cm ±19x10,5,↔ø5,5

P 6 705/17R ①

P 6 705/17P ①
cm ±17x19,↔12

T 6 707/17R ①

T 6 707/17P ①
cm ±17x19,↔10x6,5



P 19 101/09 cm 9x12

P 19 101/11 cm 11x15

P 19 101/13 cm 13x18



P 21 081/09 cm 9x12

P 21 081/10 cm 10x15

P 21 081/11 cm 11x15

P 21 081/13 cm 13x18



P 10 307/18
cm ±18x14,↔12,5

T 10 320/18
cm ±18x14,↔ø7

portafiori
vasche
lampade

porte-fleurs
vases
lampes

vases
and lamps

bucaros
jardineras
lamparas

blumenvasen
schalen
lampen



GIGLIO

Designed by Gianluca Ugoletti



P 5 430/20R ◀

P 5 430/20P ▶
cm :20x12,5x11

T 5 432/20R ◀

T 5 432/20P ▶
cm :20x12,5x9x8

P 9 130/20
cm :20x9,5x8,5

T 9 132/20
cm :20x9,5x7x6

P 5 440/18R ◀

P 5 440/18P ▶
cm :18,5x17x10

T 5 442/18R ◀

T 5 442/18P ▶
cm :18,5x17x14x7,5



P 11 930/17
cm :17,5x12x11,5

T 11 932/17
cm :17,5x12x8



T 9 132/26
cm :26x11,5x7,5x6,5



T 5 432/29R ◀

T 5 432/29P ▶
cm :29x15,5x11x10



T 11 932/23
cm :24x15x9



portafiori
vasche
lampade

porte-fleurs
vases
lampes

vases
and lamps

bucaros
jardineras
lamparas

blumenvasen
schalen
lampen



P 5 275/19
cm ±20x11,±11

I 5 370/19
cm ±20x11,±07

P 9 266/21
cm ±21x9,±9

I 9 370/21
cm ±21x9,±05

P 4 275/17
cm ±18x18,±12

I 4 286/17
cm ±18x18,±12x6

CINERARI E OSSARI



P 9 266/14
cm ±14,5x7,±7

P 5 275/12
cm ±12x7,5,±7

I 9 370/14
cm ±14,5x7,±03,5

I 5 370/12
cm ±12x7,5,±04



P 4 278/19
cm ±18x14,±8,5



I 9 370/27
cm ±27x11,±06



I 5 370/28
cm ±29x16,±09



P 10 828/24
cm ±26,5x13,±14

I 10 827/24
cm ±24x13,±8x8

portafiori
vasche
lampade

porte-fleurs
vases
lampes

vases
and lamps

bucaros
jardineras
lamparas

blumenvasen
schalen
lampen



VERSAILLES



P 5 001/20
cm ±20x12,±12

T 5 010/20
cm ±20x12,±ø6

P 9 031/21
cm ±21x9,±9

T 9 040/21
cm ±21x9,±ø5

P 4 025/19
cm ±18x17,±12

T 4 036/19
cm ±18x17,±10x5



P 19 823/07 cm 7x9

P 19 823/09 cm 9x12

P 19 823/11 cm 11x15

P 19 823/13 cm 13x18

P 19 823/18 cm 18x24



T 9 040/30
cm ±26x12,±ø6



T 5 010/30
cm ±28x16,±ø7



T 10 829/24
cm ±24x13,±8x8



STELO

Designed by Vittorio Asti



portafiori
vasche
lampade

porte-fleurs
vases
lampes

vases
and lamps

bucaros
jardineras
lamparas

blumenvasen
schalen
lampen



- P 4 698/19R**
- P 4 698/19P**
- cm ±19,5x10,±11
- T 4 701/19R**
- T 4 701/19P**
- cm ±19,5x10,±05



- P 9 114/18**
- cm ±18x9,±9,5
- T 9 125/18**
- cm ±18x9,±05



- P 10 594/17**
- cm ±17,5x12,±11,5
- T 10 606/17**
- cm ±17,5x12,±08

CINERARI E OSSARI



- P 9 114/13**
- cm ±13,5x5,5,±6,5
- T 9 125/13**
- cm ±13,5x5,5,±03



- P 4 698/13**
- cm ±13x6,±7
- T 4 701/13**
- cm ±13x6,±03



- T 9 125/24**
- cm ±24,5x11,5,±06,5



- T 4 701/28**
- cm ±28x14,±07,5



- T 10 903/24**
- cm ±26x15,±09

portafiori
vasche
lampade

porte-fleurs
vases
lampes

vases
and lamps

bucaros
jardineras
lamparas

blumenvasen
schalen
lampen



CALLA

Designed by Vittorio Asti



P 4 517/20
cm :20,5x12,2x11
T 4 528/20
cm :20,5x12,2xØ7



P 9 034/18
cm :17,5x10,5x10,5
T 9 045/18
cm :17,5x10,5xØ6



P 10 719/16
cm :15,5x13,2x12,5
T 10 721/16
cm :15,5x13,2xØ7,5
T 10 721/18
cm :18,5x16,2xØ9

CINERARI E OSSARI



P 7 054/12
cm :12x7,5x7,5



P 1 057/12
cm :12x7,5x7

T 7 065/12
cm :12x7,5xØ4,5

T 1 068/12
cm :12x7,5xØ4,5



P 19 275/09
cm 9x12



P 21 119/09
cm 9x12



T 9 045/25
cm :26,5x12,2xØ7,5



T 4 528/29
cm :29x17,5xØ10



T 10 708/29
cm :29x16,5x10,5x10,5

P 21 119/10
cm 10x15

T 4 528/34
cm :34x21,2xØ13,5

P 21 119/11
cm 11x15

T 4 528/40
cm :40x25,5xØ15

ORCHIDEA



portafiori
vasche
lampade

porte-fleurs
vases
lampes

vases
and lamps

bucaros
jardineras
lamparas

blumenvasen
schalen
lampen



P 4 415/19
cm ±20x11,±11,5

I 4 426/19
cm ±21x11,±ø8



P 8 933/13
cm ±13x11,±8,5

I 8 944/13
cm ±13x11,±11x8



P 4 437/15
cm ±15,5x14,±9,5,±13,5x8,5
Predisposta anche per
l'applicazione a terreno



P 19 253/09 cm 9x12

P 19 253/11 cm 11x15



P 10 617/16
cm ±16x11,5,±10

I 10 628/16
cm ±17x11,5,±ø8



P 7 032/9
cm ±9,5x5,±5,5

I 7 043/9
cm ±9,5x5,±5x5,5



P 1 035/11
cm ±11x5,±5,5

I 1 046/11
cm ±11x5,±ø5

CINERARI E OSSARI

portafiori
vasche
lampade

porte-fleurs
vases
lampes

vases
and lamps

bucaros
jardineras
lamparas

blumenvasen
schalen
lampen



PETALI



P 5 872/20P
cm ±19,5x11,5,±12,5

T 5 883/20P
cm ±19,5x11,5,±ø5,5

P 9 774/19
cm ±19x8,5,±9

T 9 785/19
cm ±19x8,5,±ø4

P 5 848/17
cm ±17,5x17,±10,5

T 5 859/17
cm ±17,5x17,±9x4



T 9 785/26
cm ±27x11,5,±ø6



T 10 829/24
cm ±24x13,±8x8



T 5 883/30P
cm ±30x16,±ø7

GIADA



portafiori
vasche
lampade

porte-fleurs
vases
lampes

vases
and lamps

bucaros
jardineras
lamparas

blumenvasen
schalen
lampen



P 7 007/20
cm ±20x12,±9



P 4 013/20P Ⓟ
cm ±20x15,5,±9



P 4 202/18 Ⓟ
cm ±18x26,±9,5



P 4 318/17 Ⓟ
cm ±17x45,5,±10



P 11 053/18
cm ±18x14,±11

La serie è predisposta per l'applicazione sia a parete che a terreno



P 7 431/18
cm ±18x10,5,±7,±10x6
Predisposta anche per
l'applicazione a terreno



P 1 593/14 Ⓟ
cm ±14,5x24,5,±9,±24,5x7,5
Predisposta anche per
l'applicazione a terreno

portafiori
vasche
lampade

porte-fleurs
vases
lampes

vases
and lamps

bucaros
jardineras
lamparas

blumenvasen
schalen
lampen



LINEAR



P 8 077/17
cm ±17x8,5±9,5
T 8 088/17
cm ±17x8,5±07



P 2 559/19R
cm ±19,5x8,5±9,5
T 2 561/19R
cm ±19,5x8,5±07



P 8 099/17
cm ±17x8,5±9,5
T 8 102/17
cm ±17x8,5±07



P 2 572/19R
cm ±19,5x8,5±9,5
T 2 583/19R
cm ±19,5x8,5±07



P 9 843/20
cm ±20,5x9,5±10



P 6 667/20
cm ±20,5x10,5±11,5



P 10 402/17
cm ±16,5x11,5±12

FIORE LINE



portafiori
vasche
lampade

porte-fleurs
vases
lampes

vases
and lamps

bucaros
jardineras
lamparas

blumenvasen
schalen
lampen



P 9 231/21
cm ±21,5x11,5x8
Semilampada ☺



P 4 601/21 ⓘ
cm ±20,5x18,5x9,5
Semivasca ☺

GENZIANA



portafiori
vasche
lampade

porte-fleurs
vases
lampes

vases
and lamps

bucaros
jardineras
lamparas

blumenvasen
schalen
lampen



P 7 023/20
cm ±20x12,5x10
Semilampada ☺



P 4 032/20P ⓘ
cm ±20x15,5x10
Semivaso ☺



P 4 228/18 ⓘ
cm ±18x26,5x10
Semivasca ☺

La serie è predisposta per l'applicazione sia a parete che a terreno

portafiori
vasche
lampade

porte-fleurs
vases
lampes

vases
and lamps

bucaros
jardineras
lamparas

blumenvasen
schalen
lampen



TULIPANO



P 9 060/20
cm ±20x14,5±7,5
Semilampada ☺



P 4 570/20 
cm ±19x18,5±9
Semivasca ☺



P 9 082/20
cm ±20x14,5±7,5
Semilampada ☺



P 4 592/20 
cm ±19x18,5±9
Semivasca ☺



portafiori
vasche
lampade

porte-fleurs
vases
lampes

vases
and lamps

bucaros
jardineras
lamparas

blumenvasen
schalen
lampen



P 7 511/19
cm ±20x8,±10,5



P 1 673/18 ◉
cm ±18x9,±11,5



P 7 497/19
cm ±20x8,±10,5



P 1 695/18 ◉
cm ±18x9,±11,5



P 7 555/16
cm ±16x6,±9



P 7 091/18
cm ±18x9,±11



P 7 577/20
cm ±20x21,±9,5



P 7 599/19
cm ±20x7,±9,5



T 7 566/15
cm ±15,5x6,±ø4



T 1 786/15 ◉
cm ±14,5x8,±6x6



T 7 588/20
cm ±20,5x21,±ø6



T 1 764/23 ◉
cm ±25x11,±ø5



T 7 602/21
cm ±22x7,±ø5

T 1 786/20 ◉
cm ±20x11,±8x8

T 1 786/25 ◉
cm ±24,5x13,5,±10x10

portafiori
vasche
lampade

porte-fleurs
vases
lampes

vases
and lamps

bucaros
jardineras
lamparas

blumenvasen
schalen
lampen



P 1 833/20 ◐
cm ±20x10,±11,5



P 1 731/15 ◐
cm ±16x11,±11,5



P 1 753/21 ◐
cm ±22,5x11,±11,5



P 1 775/17 ◐
cm ±17x8,±10
P 1 775/20 ◐
cm ±21,5x11,±11,5
P 1 775/25 ◐
cm ±25x13,5,±14,5



P 10 116/20
cm ±19,5x9,5,±10,5



P 10 138/14
cm ±14,5x12,±12



P 10 151/18
cm ±20x12,5,±14



P 10 127/22
cm ±21,5x9,5,±10,5



P 10 149/17
cm ±16,5x12,±12



P 10 162/23
cm ±25x12,5,±14



DECORATI

-  GRIGIO
"Delicatezza e leggerezza"
-  NOCCIOLA
"Purezza e semplicità"
-  MARRONE
"Forza e determinazione"
-  ROSA
"Dolcezza e sensibilità"
-  ROSSO
"Passione e intensità"
-  GIALLO OCRA
"Amicizia ed energia"
-  BLU
"Armonia e fedeltà"
-  VERDE FOGLIA
"Sicurezza ed affidabilità"
-  VERDE ACQUA
"Amore e libertà"

portafiori
vasche
lampade

porte-fleurs
vases
lampes

vases
and lamps

bucaros
jardineras
lamparas

blumenvasen
schalen
lampen



FIORE LINE GRIGIO

"Delicatezza e leggerezza"



P 1 059/21P
cm ±21x11,5,±11,5



P 7 162/19
cm ±19x9,±8,5



P 2 042/18P
cm ±18,5x19,±14



P 19 066/09
cm 9x12



P 21 095/09
cm 9x12



P 23 070/15
cm ±15x8



T 13 162/10P
cm ±10x16

SEMIVASO



P 1 490/13
cm ±14x7,±4

P 1 490/21
cm ±21x11,5,±6



P 2 996/12P
cm ±12x4,5,±3,5



P 7 162/14
cm ±14x7,±7,5



P 1 059/13P
cm ±13x7,±7,5

CINERARI E OSSARI

FIORE LINE

NOCCIOLA

"Purezza e semplicità"



portafiori
vasche
lampade

porte-fleurs
vases
lampes

vases
and lamps

bucaros
jardineras
lamparas

blumenvasen
schalen
lampen



P 1 044/21P
cm ±21x11,5,±11,5



P 7 144/19
cm ±19x9,±8,5



P 2 035/18P
cm ±18,5x19,±14

CINERARI E OSSARI



P 2 962/12P
cm ±12x4,5,±3,5



P 7 144/14
cm ±14x7,±7,5



P 1 044/13P
cm ±13x7,±7,5



P 19 052/09
cm 9x12



P 21 076/09
cm 9x12



P 23 048/15
cm ±15x8



T 13 093/10P
cm ±10x16

SEMIVASO



P 1 472/13
cm ±14x7,±4

P 19 052/11
cm 11x15

P 21 076/10
cm 10x15

P 23 048/20
cm ±20x10

P 1 472/21
cm ±21x11,5,±6

P 21 076/11
cm 11x15

P 23 048/25
cm ±25x12

portafiori
vasche
lampade

porte-fleurs
vases
lampes

vases
and lamps

bucaros
jardineras
lamparas

blumenvasen
schalen
lampen



FIORE LINE

MARRONE

“Forza e determinazione”



P 1 039/21P ⓘ
cm :21x11,5x11,5



P 7 127/19
cm :19x9,2x8,5



P 2 011/18P ⓘ
cm :18,5x19,2x14

CINERARI E OSSARI



P 19 044/09
cm 9x12



P 21 061/09
cm 9x12



P 23 024/15
cm :15x8



P 13 062/10P ⓘ
cm :10x16

SEMIVASO



P 1 425/13
cm :14x7,2x4



P 2 933/12P ⓘ
cm :12x4,5x3,5



P 7 127/14
cm :14x7,2x7,5



P 1 039/13P ⓘ
cm :13x7,2x7,5

P 19 044/11
cm 11x15

P 21 061/10
cm 10x15

P 23 024/20
cm :20x10

P 1 425/21 ⓘ
cm :21x11,5x6

P 21 061/11
cm 11x15

P 23 024/25
cm :25x12

FIORE LINE

ROSA

“Dolcezza e sensibilità”



portafiori
vasche
lampade

porte-fleurs
vases
lampes

vases
and lamps

bucaros
jardineras
lamparas

blumenvasen
schalen
lampen



P 1 021/21P
cm ±21x11,5,±11,5



P 7 117/19
cm ±19x9,±8,5



P 2 004/18P
cm ±18,5x19,±14

CINERARI E OSSARI



P 2 910/12P
cm ±12x4,5,±3,5



P 7 117/14
cm ±14x7,±7,5



P 1 021/13P
cm ±13x7,±7,5



P 19 001/09
cm 9x12



P 21 006/09
cm 9x12



P 23 007/15
cm ±15x8



P 13 026/10P
cm ±10x16

SEMIVASO



P 1 415/13
cm ±14x7,±4

P 19 001/11
cm 11x15

P 21 006/10
cm 10x15

P 23 007/20
cm ±20x10

P 1 415/21P
cm ±21x11,5,±6

P 21 006/11
cm 11x15

P 23 007/25
cm ±25x12

portafiori
vasche
lampade

porte-fleurs
vases
lampes

vases
and lamps

bucaros
jardineras
lamparas

blumenvasen
schalen
lampen



FIORE LINE

ROSSO

“Passione e intensità”



P 1 043/21P
cm ±21x11,5±11,5



P 7 142/19
cm ±19x9±8,5



P 2 022/18P
cm ±18,5x19±14

CINERARI E OSSARI

SEMIVASO



P 19 047/09
cm 9x12



P 21 071/09
cm 9x12



P 23 045/15
cm ±15x8



P 13 084/10P
cm ±10x16



P 1 455/13
cm ±14x7±4



P 2 955/12P
cm ±12x4,5±3,5



P 7 142/14
cm ±14x7±7,5



P 1 043/13P
cm ±13x7±7,5

P 19 047/11
cm 11x15

P 21 071/10
cm 10x15

P 23 045/20
cm ±20x10

P 1 455/21
cm ±21x11,5±6

P 21 071/11
cm 11x15

P 23 045/25
cm ±25x12

FIORE LINE

GIALLO OCRA

"Amicizia ed energia"



portafiori
vasche
lampade

porte-fleurs
vases
lampes

vases
and lamps

bucaros
jardineras
lamparas

blumenvasen
schalen
lampen



P 1 041/21P
cm ±21x11,5,±11,5



P 7 132/19
cm ±19x9,±8,5



P 2 017/18P
cm ±18,5x19,±14

CINERARI E OSSARI



P 2 937/12P
cm ±12x4,5,±3,5



P 7 132/14
cm ±14x7,±7,5



P 1 041/13P
cm ±13x7,±7,5



P 19 046/09
cm 9x12



P 21 069/09
cm 9x12



P 23 028/15
cm ±15x8



P 13 079/10P
cm ±10x16

SEMIVASO



P 1 431/13
cm ±14x7,±4

P 19 046/11
cm 11x15

P 21 069/10
cm 10x15

P 23 028/20
cm ±20x10

P 1 431/21P
cm ±21x11,5,±6

P 21 069/11
cm 11x15

P 23 028/25
cm ±25x12

portafiori
vasche
lampade

porte-fleurs
vases
lampes

vases
and lamps

bucaros
jardineras
lamparas

blumenvasen
schalen
lampen



FIORE LINE

BLU

"Armonia e fedeltà"



P 1 055/21P
cm ±21x11,5,±11,5



P 7 159/19
cm ±19x9,±8,5



P 2 040/18P
cm ±18,5x19,±14

CINERARI E OSSARI



P 19 061/09
cm 9x12



P 21 092/09
cm 9x12



P 23 065/15
cm ±15x8



P 13 137/10P
cm ±10x16

SEMIVASO



P 1 485/13
cm ±14x7,±4



P 2 967/12P
cm ±12x4,5,±3,5



P 7 159/14
cm ±14x7,±7,5



P 1 055/13P
cm ±13x7,±7,5

P 19 061/11
cm 11x15

P 21 092/10
cm 10x15

P 23 065/20
cm ±20x10

P 1 485/21
cm ±21x11,5,±6

P 21 092/11
cm 11x15

P 23 065/25
cm ±25x12

FIORE LINE

VERDE FOGLIA

“Sicurezza ed affidabilità”



portafiori
vasche
lampade

porte-fleurs
vases
lampes

vases
and lamps

bucaros
jardineras
lamparas

blumenvasen
schalen
lampen



P 1 051/21P
cm ±21x11,5,±11,5



P 7 153/19
cm ±19x9,±8,5



P 2 038/18P
cm ±18,5x19,±14

CINERARI E OSSARI



P 2 964/12P
cm ±12x4,5,±3,5



P 7 153/14
cm ±14x7,±7,5



P 1 051/13P
cm ±13x7,±7,5



P 19 057/09
cm 9x12



P 21 080/09
cm 9x12



P 23 057/15
cm ±15x8



P 13 096/10P
cm ±10x16

SEMIVASO



P 1 480/13
cm ±14x7,±4

P 19 057/11
cm 11x15

P 21 080/10
cm 10x15

P 23 057/20
cm ±20x10

P 1 480/21
cm ±21x11,5,±6

P 21 080/11
cm 11x15

P 23 057/25
cm ±25x12

portafiori
vasche
lampade

porte-fleurs
vases
lampes

vases
and lamps

bucaros
jardineras
lamparas

blumenvasen
schalen
lampen



FIORE LINE

VERDE ACQUA

“Amore e libertà”



P 1 062/21P ⓘ
cm ±21x11,5,±11,5



P 7 170/19
cm ±19x9,±8,5



P 2 041/18P ⓘ
cm ±18,5x19,±14

CINERARI E OSSARI



P 19 073/09
cm 9x12



P 21 098/09
cm 9x12



P 23 081/15
cm ±15x8



P 13 181/10P ⓘ
cm ±10x16

SEMIVASO



P 1 493/13
cm ±14x7,±4



P 2 998/12P ⓘ
cm ±12x4,5,±3,5



P 7 170/14
cm ±14x7,±7,5



P 1 062/13P ⓘ
cm ±13x7,±7,5

P 19 073/11
cm 11x15

P 21 098/10
cm 10x15

P 23 081/20
cm ±20x10

P 1 493/21 ⓘ
cm ±21x11,5,±6

P 21 098/11
cm 11x15

P 23 081/25
cm ±25x12



ESEMPIO
DI MONTAGGIO
SEMIVASO
CON FIORE
IN BRONZO

I semivasi Fiore Line,
sia da loculo che da ossario,
si adattano ad ogni tipologia
di fiore in bronzo.



semivasi

demi
vases

half
vases

bucaros
medio

hälfte
blumenvasen



FIORE LINE SEMIVASI



P 1 408/13
cm ±14x7,±4

P 1 408/21 ⓘ
cm ±21x11,5,±6
Bronzo



P 1 473/13
cm ±14x7,±4

P 1 473/21 ⓘ
cm ±21x11,5,±6
Botticino



P 1 496/13
cm ±14x7,±4

P 1 496/21 ⓘ
cm ±21x11,5,±6
Carrara



P 1 452/13
cm ±14x7,±4

P 1 452/21 ⓘ
cm ±21x11,5,±6
Uniblanc



P 1 490/13
cm ±14x7,±4

P 1 490/21 ⓘ
cm ±21x11,5,±6
Grigio



P 1 472/13
cm ±14x7,±4

P 1 472/21 ⓘ
cm ±21x11,5,±6
Nocciola



P 1 425/13
cm ±14x7,±4

P 1 425/21 ⓘ
cm ±21x11,5,±6
Marrone



P 1 415/13
cm ±14x7,±4

P 1 415/21 ⓘ
cm ±21x11,5,±6
Rosa



P 1 455/13
cm ±14x7,±4

P 1 455/21 ⓘ
cm ±21x11,5,±6
Rosso



P 1 431/13
cm ±14x7,±4

P 1 431/21 ⓘ
cm ±21x11,5,±6
Giallo ocra



P 1 485/13
cm ±14x7,±4

P 1 485/21 ⓘ
cm ±21x11,5,±6
Blu



P 1 480/13
cm ±14x7,±4

P 1 480/21 ⓘ
cm ±21x11,5,±6
Verde foglia



P 1 493/13
cm ±14x7,±4

P 1 493/21 ⓘ
cm ±21x11,5,±6
Verde acqua

Per i caratteri decorati, vedi sezione caratteri da pag. 262.

CAGGIATI *Caggiati*



BLU



GRIGIO



NOCCIOLA



MARRONE



ROSA



ROSSO



GIALLO OCRA



VERDE FOGLIA



VERDE ACQUA



BOTTICINO

portafiori
vasche
lampade

porte-fleurs
vases
lampes

vases
and lamps

bucaros
jardineras
lamparas

blumenvasen
schalen
lampen



OLMO
BOTTICINO
Designed by Alessandro Asti



P 2 192/20R ①
cm ±20x13,±11



P 9 531/19
cm ±19x11,±9,5



P 2 251/18R ①
cm ±18x18,±12



P 19 766/07
cm 7x9

P 19 766/08
cm 8x10

P 19 766/09
cm 9x12

P 19 766/11
cm 11x15

P 19 766/13
cm 13x18



P 21 017/08
cm 8x10

P 21 017/09
cm 9x12

P 21 017/10
cm 10x15

P 21 017/11
cm 11x15

P 21 017/13
cm 13x18

CINERARI E OSSARI



P 9 531/16
cm ±16x8,±7



P 2 192/13P ①
cm ±13x8,±7,5

NILO BOTTICINO

Designed by Alberto Nodolini



portafiori
vasche
lampade

porte-fleurs
vases
lampes

vases
and lamps

bucaros
jardineras
lamparas

blumenvasen
schalen
lampen



P 2 978/20 
cm ±20x13,5,±13

T 2 991/20 
cm ±20x13,5,±ø6,5

P 9 106/19
cm ±18,5x11,±10,5

T 9 112/19
cm ±19x11,±ø4,5

P 2 979/17 
cm ±17x19,±13

T 2 992/17 
cm ±17x19,±11,5x6,5



P 19 041/09 cm 9x12

P 19 041/11 cm 11x15



P 21 047/09 cm 9x12

P 21 047/10 cm 10x15

P 21 047/11 cm 11x15

portafiori
vasche
lampade

porte-fleurs
vases
lampes

vases
and lamps

bucaros
jardineras
lamparas

blumenvasen
schalen
lampen



FIORE LINE BOTTICINO

Designed by Alessandro Asti



P 1 157/21P
cm ±21x11,5,±11,5



P 7 149/19
cm ±19x9,±8,5



P 2 078/18P
cm ±18,5x19,±14

CINERARI E OSSARI

SEMIVASO



P 19 010/09
cm 9x12

P 19 010/11
cm 11x15

P 19 010/13
cm 13x18



P 21 048/09
cm 9x12

P 21 048/10
cm 10x15

P 21 048/11
cm 11x15

P 21 048/13
cm 13x18



P 1 473/13
cm ±14x7,±4

P 1 473/21
cm ±21x11,5,±6



P 2 961/12P
cm ±12x4,5,±3,5



P 7 149/14
cm ±14x7,±7,5



P 1 157/13P
cm ±13x7,±7,5

Con perni
e biadesivo

VENUS BOTTICINO

Designed by Gianluca Ugoletti



portafiori
vasche
lampade

porte-fleurs
vases
lampes

vases
and lamps

bucaros
jardineras
lamparas

blumenvasen
schalen
lampen



P 1 520/20R ◉
cm :19,5x11,5↗10,5

I 1 540/20R ◉
cm :19,5x11,5↗6x6



P 7 080/20
cm :20x10↗9

I 7 095/20
cm :20x10↗6x5,5



P 1 527/19R ◉
cm :18,5x17↗11,5

I 1 550/19R ◉
cm :18,5x17↗11x7

CINERARI E OSSARI



P 7 080/15
cm :15x7↗7



P 1 520/13P ◉
cm :13x7↗7



P 19 350/09
cm 9x12

P 19 350/11
cm 11x15



P 21 220/09
cm 9x12

P 21 220/10
cm 10x15

P 21 220/11
cm 11x15



P 10 597/17
cm :17,5x12↗11,5

I 10 607/17
cm :17,5x12↗ø8

portafiori
vasche
lampade

porte-fleurs
vases
lampes

vases
and lamps

bucaros
jardineras
lamparas

blumenvasen
schalen
lampen



LINDA BOTTICINO



P 2 987/20R
cm ±20x12,±11

T 2 988/20R
cm ±20x12,±07

P 9 117/19
cm ±19x10,5,±8,5

T 9 118/19
cm ±19x10,5,±05,5

P 2 989/17R
cm ±17x19,±12

T 2 990/17R
cm ±17x19,±10x6,5



P 19 010/09
cm 9x12

P 19 010/11
cm 11x15

P 19 010/13
cm 13x18



P 21 048/09
cm 9x12

P 21 048/10
cm 10x15

P 21 048/11
cm 11x15

P 21 048/13
cm 13x18



P 10 597/17
cm ±17,5x12,±11,5

T 10 607/17
cm ±17,5x12,±08

AURORA BOTTICINO

Designed by Alessandro Asti



portafiori
vasche
lampade

porte-fleurs
vases
lampes

vases
and lamps

bucaros
jardineras
lamparas

blumenvasen
schalen
lampen



P 1 440/20P
cm ±20x12,5x11



P 8 390/21
cm ±21,5x9,5x8,5



P 2 440/20P
cm ±20x20x11,5



- P 19 766/07** cm 7x9
- P 19 766/08** cm 8x10
- P 19 766/09** cm 9x12
- P 19 766/11** cm 11x15
- P 19 766/13** cm 13x18



- P 21 017/08** cm 8x10
- P 21 017/09** cm 9x12
- P 21 017/10** cm 10x15
- P 21 017/11** cm 11x15
- P 21 017/13** cm 13x18

portafiori
vasche
lampade

porte-fleurs
vases
lampes

vases
and lamps

bucaros
jardineras
lamparas

blumenvasen
schalen
lampen



LE CANTARE BOTTICINO

Designed by Alessandro Asti



P 5 977/19R ●
cm ±19,5x11,±11,5



P 9 190/19
cm ±19,5x9,±9



P 4 897/18R ●
cm ±18,5x17,±11,5



P 19 010/09 cm 9x12
P 19 010/11 cm 11x15
P 19 010/13 cm 13x18



P 21 048/09 cm 9x12
P 21 048/10 cm 10x15
P 21 048/11 cm 11x15
P 21 048/13 cm 13x18

CLAUDIA BOTTICINO

Designed by Vittorio Asti



portafiori
vasche
lampade

porte-fleurs
vases
lampes

vases
and lamps

bucaros
jardineras
lamparas

blumenvasen
schalen
lampen



P 2 190/19
cm ±19x11,5±10,5

I 2 201/19
cm ±19x11,5±10,7



P 7 850/17
cm ±17x10±9

I 7 869/17
cm ±17x10±7,5x5,5

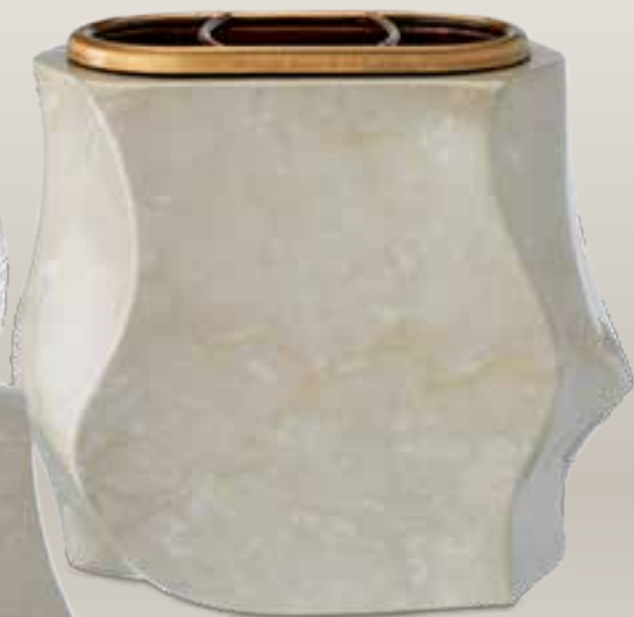

P 2 194/16
cm ±16x18,5±11,5±15x10
Predisposta anche per
l'applicazione a terreno



P 24 274/12 cm ±12x6,5

P 24 274/15 cm ±15x8

P 24 274/20 cm ±20x10



P 19 190/09 cm 9x12

P 19 190/11 cm 11x15



P 7 834/19
cm ±19x16±9



P 10 597/17
cm ±17,5x12±11,5

I 10 607/17
cm ±17,5x12±10,8

portafiori
vasche
lampade

porte-fleurs
vases
lampes

vases
and lamps

bucaros
jardineras
lamparas

blumenvasen
schalen
lampen



TULIPANO BOTTICINO

Designed by Alessandro Asti



P 2 974/20 ⓘ
cm ±19,5x10,±11

T 2 994/20 ⓘ
cm ±19,5x10,±ø5



P 9 102/18
cm ±18x9,5,±10

T 9 072/18
cm ±18x9,5,±ø5



P 2 970/18 ⓘ
cm ±19x15,5,±11

T 2 999/18 ⓘ
cm ±19x15,5,±11x4,5



P 19 010/09 cm 9x12

P 19 010/11 cm 11x15

P 19 010/13 cm 13x18



P 21 048/09 cm 9x12

P 21 048/10 cm 10x15

P 21 048/11 cm 11x15

P 21 048/13 cm 13x18



P 10 597/17
cm ±17,5x12,±11,5

T 10 607/17
cm ±17,5x12,±ø8

ATHENEAE BOTTICINO

Designed by Gianluca Ugoletti



portafiori
vasche
lampade

porte-fleurs
vases
lampes

vases
and lamps

bucaros
jardineras
lamparas

blumenvasen
schalen
lampen



P 5 830/20
cm ±20x10,5x11,5

T 5 831/20
cm ±20x10,5x∅6

T 5 831/28
cm ±28x14x∅8,5



P 9 607/18
cm ±18x8,5x9

T 9 608/18
cm ±18x8,5x∅5

T 9 608/26
cm ±26x11,5x∅6,5



P 5 832/16
cm ±17x16x12

T 5 833/16
cm ±17x16x11,5x6,5



P 24 275/15
cm ±15x8

P 24 275/20
cm ±20x10



P 19 590/09
cm 9x12

P 19 590/11
cm 11x15
Con filetto bronzo



P 21 300/09
cm 9x12

P 21 300/10
cm 10x15

P 21 300/11
cm 11x15
Con filetto bronzo

portafiori
vasche
lampade

porte-fleurs
vases
lampes

vases
and lamps

bucaros
jardineras
lamparas

blumenvasen
schalen
lampen



ATHENEA BOTTICINO

CINERARI E OSSARI



P 9 607/15
cm ±14,5x6,5±7



P 5 830/13 ⓘ
cm ±13x7,±7,5



P 10 597/17
cm ±17,5x12,±11,5

I 10 607/17
cm ±17,5x12,±ø8



P 5 790/16 ⓘ
cm ±16,5x30,5±12,5



I 10 607/25
cm ±26x15,±ø9



I 13 783/21
cm ±21x11,±ø6,5



I 13 016/95R ⓘ
cm ±9,5x16

GRAZIA BOTTICINO

Designed by Gianluca Ugoletti



portafiori
vasche
lampade

porte-fleurs
vases
lampes

vases
and lamps

bucaros
jardineras
lamparas

blumenvasen
schalen
lampen



P 2 229/20R
cm ±20x11,5, ±12

I 2 250/20R
cm ±20x11,5, ±ø6,5



P 9 022/21
cm ±21x10, ±10,5

I 9 087/21
cm ±21x10, ±ø6



P 4 256/19R
cm ±19x17,5, ±11,5

I 4 260/19R
cm ±19x17,5, ±12x6



P 24 256/15
cm ±15x7

P 24 256/20
cm ±20x8,5

P 24 256/25
cm ±25x11



P 19 590/09
cm 9x12

P 19 590/11
cm 11x15
Con filetto bronzo



P 21 300/09
cm 9x12

P 21 300/10
cm 10x15

P 21 300/11
cm 11x15
Con filetto bronzo



P 10 597/17
cm ±17,5x12, ±11,5

I 10 607/17
cm ±17,5x12, ±ø8

portafiori
vasche
lampade

porte-fleurs
vases
lampes

vases
and lamps

bucaros
jardineras
lamparas

blumenvasen
schalen
lampen



GIADA BOTTICINO



P 7 026/20
cm ±20x12,9



P 4 019/20P ⓘ
cm ±20x15,5,9



P 24 274/12 cm ±12x6,5
P 24 274/15 cm ±15x8
P 24 274/20 cm ±20x10



P 19 010/09 cm 9x12
P 19 010/11 cm 11x15
P 19 010/13 cm 13x18



P 21 048/09 cm 9x12
P 21 048/10 cm 10x15
P 21 048/11 cm 11x15
P 21 048/13 cm 13x18



P 4 207/18P ⓘ
cm ±18x26,9,5



P 11 061/18
cm ±18x14,11

FIORE LINE

BOTTICINO



portafiori
vasche
lampade

porte-fleurs
vases
lampes

vases
and lamps

bucaros
jardineras
lamparas

blumenvasen
schalen
lampen



P 9 233/21
cm :21,5x11,5,7-8
Semilampada ☺



P 4 603/21 Ⓟ
cm :20,5x18,7-9,5
Semivasca ☺

TULIPANO

BOTTICINO



portafiori
vasche
lampade

porte-fleurs
vases
lampes

vases
and lamps

bucaros
jardineras
lamparas

blumenvasen
schalen
lampen



P 2 980/20 Ⓟ
cm :19x18,5,7-9
Semivasca ☺

P 9 107/20
cm :20x14,5,7-7,5
Semilampada ☺



P 9 065/20
cm :20x14,5,7-7,5
Con filetto bronzo
Semilampada ☺

P 4 577/20 Ⓟ
cm :19x18,5,7-9
Con filetto bronzo
Semivasca ☺

cinerari
ed ossari

vases et
lampes pour
colombarium

accessories
for ossuaries

oasarios

zubehör
für ossarium



CINERARI E OSSARI

BOTTICINO



P 9 531/16
cm ±16x8,7



P 2 192/13P ⓘ
cm ±13x8,7,5



P 7 149/14
cm ±14x7,7,5



P 1 157/13P ⓘ
cm ±13x7,7,5



P 7 080/15
cm ±15x7,7



P 1 520/13P ⓘ
cm ±13x7,7



P 7 270/15
cm ±15x7,6,5



P 2 178/13P ⓘ
cm ±13x7,7,5



P 9 607/15
cm ±14,5x6,5,7



P 5 830/13 ⓘ
cm ±13x7,7,5

PORTA ORCHIDEA



P 2 961/12P ⓘ
cm ±12x4,5,3,5

con perni e biadesivo



P 2 952/12 ⓘ
cm ±12x5,3

con perni e biadesivo



P 2 940/12 ⓘ
cm ±12,5x4,4

con perni



P 2 935/12
cm ±11x3,5,4

con anello di bronzo

CORNICI

BOTTICINO



cornici cadres frames portarretratos bilderrahmen



P 19 766/07
cm 7x9

P 19 766/08
cm 8x10

P 19 766/09
cm 9x12

P 19 766/11
cm 11x15

P 19 766/13
cm 13x18



P 21 017/08
cm 8x10

P 21 017/09
cm 9x12

P 21 017/10
cm 10x15

P 21 017/11
cm 11x15

P 21 017/13
cm 13x18



P 19 350/09
cm 9x12

P 19 350/11
cm 11x15



P 21 220/09
cm 9x12

P 21 220/10
cm 10x15

P 21 220/11
cm 11x15



P 19 010/09
cm 9x12

P 19 010/11
cm 11x15

P 19 010/13
cm 13x18



P 21 048/09
cm 9x12

P 21 048/10
cm 10x15

P 21 048/11
cm 11x15

P 21 048/13
cm 13x18



P 19 590/09
cm 9x12

P 19 590/11
cm 11x15
Con filetto bronzo



P 21 300/09
cm 9x12

P 21 300/10
cm 10x15

P 21 300/11
cm 11x15
Con filetto bronzo



P 19 041/09
cm 9x12

P 19 041/11
cm 11x15



P 21 047/09
cm 9x12

P 21 047/10
cm 10x15

P 21 047/11
cm 11x15



P 19 190/09
cm 9x12

P 19 190/11
cm 11x15



TARGHE BOTTICINO



P 31 045/13 cm ±13x9
P 31 045/18 cm ±18x12,5



P 31 047/18 cm ±18x13
P 31 047/26 cm ±26x19,5



P 31 046/13 cm ±13x10
P 31 046/18 cm ±18x13



CROCI BOTTICINO



P 24 274/12 cm ±12x6,5
P 24 274/15 cm ±15x8
P 24 274/20 cm ±20x10



P 24 275/15 cm ±15x8
P 24 275/20 cm ±20x10



P 24 256/15 cm ±15x7
P 24 256/20 cm ±20x8,5
P 24 256/25 cm ±25x11

INCASSI BOTTICINO



incassi vases et
lampes
encastrables insert vases
and lamps for
monuments incrustados
para
monumentos versenkbare
vase und
lampen



13 783/21
cm ±21x11, ±ø6,5



13 016/95R
cm ±9,5x16



13 755/11
cm ±11,5, ±ø8
13 755/17
cm ±17, ±ø11



13 250/23R
cm ±3, ±ø13
13 250/27R
cm ±3,5, ±ø14



13 258/15R
cm ±3, ±15,5x11

GHIERE BOTTICINO



ghiere embouts
reductions ring nuts lamparas kranze



Diametro cm 6
9 901/17 cm ±17, ±ø8
con fiamma
9 896/04 cm ±3, ±ø8
senza fiamma



Diametro cm 5
9 880/13 cm ±13, ±ø6,5
con fiamma
9 885/03 cm ±2,5, ±ø6,5
senza fiamma



Diametro cm 5 ribassata
9 803/13 cm ±13, ±ø6
con fiamma
9 807/0 cm ±1,5, ±ø6
senza fiamma



Diametro cm 4
9 890/10 cm ±10, ±ø6
con fiamma
9 895/02 cm ±2, ±ø6
senza fiamma

lampade
elettriche
incassate

lampes
électriques
à encastrer

built-in
electric
lamps

lampara
eléctrica para
incrustar

elektrische
einbaulampen



INCASSI ELETTRICHE INCASSATE BOTTICINO



Portina cristallo

■ 13 200/06 cm ±4,5∅6

■ 13 200/08 cm ±5,5∅8

■ 13 200/12 cm ±6,5∅12



Portina cristallo

■ 13 215/08 cm ±3,5∅8



Portina cristallo

■ 13 230/08 cm ±3,5∅8
Cristallo con iridescenza

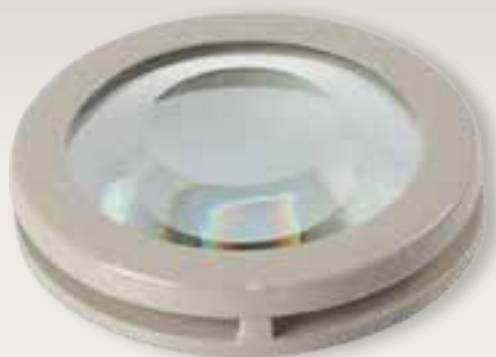

Portina cristallo

■ 13 136/06 cm ±2,5∅6

■ 13 136/08 cm ±2,5∅8

■ 13 136/10 cm ±2,5∅10

■ 13 136/12 cm ±3∅12



Portina cristallo

■ 13 185/06 cm ±4,5∅6

■ 13 185/08 cm ±5,5∅8

■ 13 185/12 cm ±6,5∅12

LAMPADE PENSILI BOTTICINO



lampade
pensili

lampes
suspendues

hänging
lamps

lamparas
colgantes

hängelampen



28 520/100
cm ±100 ø 30

28 520/134
cm ±134 ø 30



28 440/100
cm ±100 ø 52

28 440/134
cm ±134 ø 52

Accessori

Pergamena botticino per incisioni a richiesta

Le incisioni possono essere
in carattere Corsivo,
Bastone o Romano.

Les gravures peuvent être réalisées
soit en caractères cursif en
caractères bâtons, Romano.

Engravings may be in
Cursive, Block or Romano letters.

Las grabaciones pueden ser en
carácter corsivo, bastón ó Romano.

Die Praegungen können in
Schreibschrift, in Bastone oder
Romano sein.



Specificare sempre
all'ordine il tipo di carattere:

Corsivo, Bastone o Romano

Le incisioni non sono comprese nel prezzo.

Incisione alla lettera
(oltre le 40 lettere, sconto 50%)

P 22 645/70 cm ±7x10

P 22 645/100 cm ±10x15

P 22 645/110 cm ±11x20

Etriers pour les soutiens des enfeux d'épaisseur variable
 Brackets for niches support with variable thickness
 Garras para sostener lapidas de espesor variable
 Grabstein-stützhalter mit verstellbarer dicke



STAFFE BOTTICINO

Staffe con finitura Botticino, per sostegno lapidi a spessore variabile



27 320/00
 ≙ cm 0 a 1,5
 perno 6 MA



27 329/00
 ≙ cm 0 a 1,5
 perno 6 MA

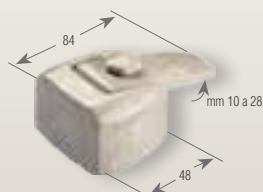

27 320/10
 ≙ cm 1 a 2,8
 perno 8 MA

Perni in acciaio inox compresi nel prezzo.

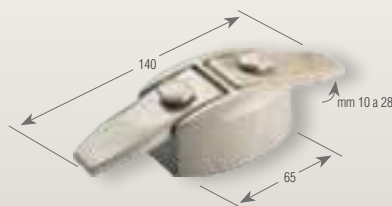

27 329/10
 ≙ cm 1 a 2,8
 perno 8 MA

Pivots en acier inox compris dans le prix.

Stainless steel pivots included in price.

Pernios en acero inox incluidos en precio.

Bolzen aus rostfreiem Stahl im Preis einschliesslich.

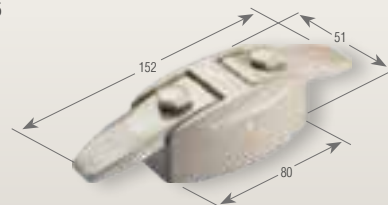

27 335/10
 ≙ cm 1 a 2,8
 perno 8 MA

A richiesta sarà fornita la documentazione tecnica relativa alla portata massima

Cabochoons avec une fonction essentiellement decorative
 Studs prevalently for decorative use
 Clavos prevalecientemente decorativos
 Beschläge mit vorwiegend dekorativer funktion



BORCHIE BOTTICINO

Borchie Botticino con funzione prevalentemente decorativa



26 108/45 ø cm 4,5
 perno 5 MA x 60



26 037/30 cm +3x3
26 037/40 cm +4x4
 perno 5 MA x 60



26 078/830 ø cm 3
26 078/855 ø cm 5,5
 perno 8 MA x 90

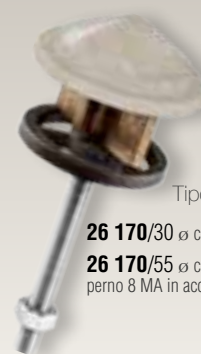

Tipo Parma

26 170/30 ø cm 3
26 170/55 ø cm 5,5
 perno 8 MA in acciaio inox

Per i caratteri in finitura botticino, vedi sezione caratteri da pag. 262.

CAGGIATI



CARRARA



OLIMPIA CARRARA

Designed by Gianluca Ugoletti



portafiori
vasche
lampade

porte-fleurs
vases
lampes

vases
and lamps

bucaros
jardineras
lamparas

blumenvasen
schalen
lampen



P 2 183/19
cm ±19x13,±12

I 2 225/19
cm ±19x13,±5x4

P 2 597/18
cm ±18x18,5,±12

I 2 794/18
cm ±18x18,5,±7x3,5

P 9 517/20
cm ±20x11,±9,5

I 9 528/20
cm ±20x11,±4x3,5



P 24 239/15 cm ±15x7

P 24 239/20 cm ±20x8,5

P 24 239/25 cm ±25x11

P 24 239/30 cm ±30x13



P 19 539/09 cm 9x12

P 19 539/11 cm 11x15

P 19 539/13 cm 13x18



P 21 476/09 cm 9x12

P 21 476/10 cm 10x15

P 21 476/11 cm 11x15

P 21 476/13 cm 13x18

portafiori
vasche
lampade

porte-fleurs
vases
lampes

vases
and lamps

bucaros
jardineras
lamparas

blumenvasen
schalen
lampen



NILO
CARRARA
Designed by Alberto Nodolini



P 6 970/20 ◐
cm ±20x13,5,±13

T 6 991/20 ◐
cm ±20x13,5,±ø6,5

P 9 992/19
cm ±18,5x11,±10,5

T 9 984/19
cm ±19x11,±ø4,5

P 6 980/17 ◐
cm ±17x19,±13

T 6 993/17 ◐
cm ±17x19,±11,5x6,5



P 19 019/09 cm 9x12

P 19 019/11 cm 11x15

P 19 019/13 cm 13x18



P 21 009/09 cm 9x12

P 21 009/10 cm 10x15

P 21 009/11 cm 11x15

P 21 009/13 cm 13x18



P 10 324/18
cm ±18x14,±12,5

T 10 331/18
cm ±18x14,±ø7

GRAZIA CARRARA

Designed by Gianluca Ugoletti



portafiori
vasche
lampade

porte-fleurs
vases
lampes

vases
and lamps

bucaros
jardineras
lamparas

blumenvasen
schalen
lampen



P 2 239/20R
cm ±20x11,5±12

P 9 033/21
cm ±21x10±10,5

P 4 250/19R
cm ±19x17,5±11,5



P 19 539/09 cm 9x12

P 19 539/11 cm 11x15

P 19 539/13 cm 13x18
Con filetto Inox



P 21 476/09 cm 9x12

P 21 476/10 cm 10x15

P 21 476/11 cm 11x15

P 21 476/13 cm 13x18
Con filetto Inox

portafiori
vasche
lampade

porte-fleurs
vases
lampes

vases
and lamps

bucaros
jardineras
lamparas

blumenvasen
schalen
lampen



FIORE LINE CARRARA



P 1 152/21P
cm ±21x11,5,±11,5



P 7 137/19
cm ±19x9,±8,5



P 2 085/18P
cm ±18,5x19,±14

CINERARI E OSSARI

SEMIVASO



T 13 021/10P
cm ±10x16



T 12 021/10R
cm ±10x16



P 1 496/13
cm ±14x7,±4

P 1 496/21
cm ±21x11,5,±6



P 2 956/12P
cm ±12x4,5,±3,5



P 7 137/14
cm ±14x7,±7,5



P 1 152/13P
cm ±13x7,±7,5

Con perni
e biadesivo

VENUS CARRARA

Designed by Gianluca Ugoletti



portafiori
vasche
lampade

porte-fleurs
vases
lampes

vases
and lamps

bucaros
jardineras
lamparas

blumenvasen
schalen
lampen



P 1 124/20R ◉
cm ±19,5x11,5,↔10,5

I 1 131/20R ◉
cm ±19,5x11,5,↔6x6



P 7 125/20
cm ±20x10,↔9

I 7 145/20
cm ±20x10,↔6x5,5



P 1 139/19R ◉
cm ±18,5x17,↔11,5

I 1 142/19R ◉
cm ±18,5x17,↔11x7

CINERARI E OSSARI



P 19 760/08 cm 8x10

P 19 760/09 cm 9x12

P 19 760/11 cm 11x15

P 19 760/13 cm 13x18



P 21 024/08 cm 8x10

P 21 024/09 cm 9x12

P 21 024/10 cm 10x15

P 21 024/11 cm 11x15

P 21 024/13 cm 13x18



P 1 124/13P ◉
cm ±13x7,↔7



P 7 125/15
cm ±15x7,↔7

portafiori
vasche
lampade

porte-fleurs
vases
lampes

vases
and lamps

bucaros
jardineras
lamparas

blumenvasen
schalen
lampen



AQUA CARRARA



P 1 104/20R
cm 20,5x13,2x12

T 1 105/20R
cm 20,5x13,2x10,7



P 7 702/20
cm 20x9,2x8

T 7 703/20
cm 20x9,2x5x5,5



P 1 106/20R
cm 20x19,2x12

T 1 107/20R
cm 20x19,2x10,5x7



P 19 125/09 cm 9x12

P 19 125/11 cm 11x15

P 19 125/13 cm 13x18



P 21 185/09 cm 9x12

P 21 185/10 cm 10x15

P 21 185/11 cm 11x15

P 21 185/13 cm 13x18

LUNA CARRARA



portafiori
vasche
lampade

porte-fleurs
vases
lampes

vases
and lamps

bucaros
jardineras
lamparas

blumenvasen
schalen
lampen



P 1 117/20R ◉
cm ±20x12,±11,5

I 1 118/20R ◉
cm ±20x12,±07

P 7 709/20
cm ±19,5x9,5,±9

I 7 710/20
cm ±19,5x9,5,±05

P 1 119/20R ◉
cm ±19,5x19,±11,5

I 1 114/20R ◉
cm ±19,5x19,±010,5x6,5

CINERARI E OSSARI



P 19 886/09 cm 9x12

P 19 886/11 cm 11x15

P 19 886/13 cm 13x18



P 21 641/09 cm 9x12

P 21 641/10 cm 10x15

P 21 641/11 cm 11x15

P 21 641/13 cm 13x18



P 1 117/13R ◉
cm ±13x8,±7,5



P 7 709/13
cm ±13x7,±6

portafiori
vasche
lampade

porte-fleurs
vases
lampes

vases
and lamps

bucaros
jardineras
lamparas

blumenvasen
schalen
lampen



IBISCO CARRARA

Designed by Gianluca Ugoletti



P 2 184/20R ◉
cm ±20x12,↔13

T 2 185/20R ◉
cm ±20x12,↔ø5,5



P 9 605/21
cm ±21x10,↔10,5

T 9 606/21
cm ±21x10,↔ø4,5



P 2 186/18R ◉
cm ±18x17,5,↔12

T 2 187/18R ◉
cm ±18x17,5,↔10,5x4,5



P 23 297/12 cm ±12x6,5

P 23 297/15 cm ±15x8

P 23 297/20 cm ±20x10

P 23 297/25 cm ±25x12

P 23 297/30 cm ±30x14



P 19 760/08 cm 8x10

P 19 760/09 cm 9x12

P 19 760/11 cm 11x15

P 19 760/13 cm 13x18



P 21 024/08 cm 8x10

P 21 024/09 cm 9x12

P 21 024/10 cm 10x15

P 21 024/11 cm 11x15

P 21 024/13 cm 13x18

DANUBIO CARRARA

Designed by Gianluca Ugoletti



portafiori
vasche
lampade

porte-fleurs
vases
lampes

vases
and lamps

bucaros
jardineras
lamparas

blumenvasen
schalen
lampen



P 2 101/20
cm ±20x13,±12

T 2 112/20
cm ±20x13,±ø6,5



P 7 253/21
cm ±21x10,±9

T 7 255/21
cm ±21x10,±ø5,5



P 2 123/19
cm ±19x18,5,±11,5

T 2 125/19
cm ±19x18,5,±12x6



P 19 125/09
cm 9x12

P 19 125/11
cm 11x15

P 19 125/13
cm 13x18



P 21 185/09
cm 9x12

P 21 185/10
cm 10x15

P 21 185/11
cm 11x15

P 21 185/13
cm 13x18



P 10 588/19
cm ±19x12,±12,5

T 10 590/19
cm ±19x12,±7x7

CINERARI E OSSARI



P 7 253/15
cm ±15x7,±6,5

T 7 255/15
cm ±15x7,±4X3,5



P 2 101/13
cm ±13x8,±7,5

T 2 112/13
cm ±13x8,±4,5X3,5

portafiori
vasche
lampade

porte-fleurs
vases
lampes

vases
and lamps

bucaros
jardineras
lamparas

blumenvasen
schalen
lampen



LE CANTARE CARRARA



P 5 901/19
cm ±19,5x11,±11,5

T 5 912/19
cm ±19,5x11,±ø8



P 9 105/19
cm ±19,5x9,±9

T 9 116/19
cm ±19,5x9,±ø4,5



P 4 911/18
cm ±18,5x17,±11,5

T 4 922/18
cm ±18,5x17,±9,5x5



P 19 886/09 cm 9x12

P 19 886/11 cm 11x15

P 19 886/13 cm 13x18



P 21 641/09 cm 9x12

P 21 641/10 cm 10x15

P 21 641/11 cm 11x15

P 21 641/13 cm 13x18

AURORA CARRARA



portafiori
vasche
lampade

porte-fleurs
vases
lampes

vases
and lamps

bucaros
jardineras
lamparas

blumenvasen
schalen
lampen



P 1 421/20P ①
cm ±20x12,5,±11

P 8 385/21
cm ±21,5x9,5,±8,5

P 2 438/20P ①
cm ±20x20,±11,5



- P 19 361/05** cm 5x7
- P 19 361/06** cm 6x8
- P 19 361/07** cm 7x9
- P 19 361/08** cm 8x10
- P 19 361/09** cm 9x12
- P 19 361/11** cm 11x15
- P 19 361/13** cm 13x18



- P 21 219/08** cm 8x10
- P 21 219/09** cm 9x12
- P 21 219/10** cm 10x15
- P 21 219/11** cm 11x15
- P 21 219/13** cm 13x18

portafiori
vasche
lampade

porte-fleurs
vases
lampes

vases
and lamps

bucaros
jardineras
lamparas

blumenvasen
schalen
lampen



LINDA
CARRARA



P 6 609/20R ⓘ

P 6 609/20P ⓘ
cm ±20x12,↗11

T 6 611/20R ⓘ

T 6 611/20P ⓘ
cm ±20x12,↗↘07

P 9 849/19
cm ±19x10,5,↗8,5

T 9 851/19
cm ±19x10,5,↗↘05,5

P 6 715/17R ⓘ

P 6 715/17P ⓘ
cm ±17x19,↗12

T 6 717/17R ⓘ

T 6 717/17P ⓘ
cm ±17x19,↗↘10x6,5



P 19 886/09 cm 9x12

P 19 886/11 cm 11x15

P 19 886/13 cm 13x18



P 21 641/09 cm 9x12

P 21 641/10 cm 10x15

P 21 641/11 cm 11x15

P 21 641/13 cm 13x18

FIORE LINE CARRARA



portafiori
vasche
lampade

porte-fleurs
vases
lampes

vases
and lamps

bucaros
jardineras
lamparas

blumenvasen
schalen
lampen



P 9 235/21
cm ±21,5x11,5±8
Semilampada ☺



P 4 605/21
cm ±20,5x18,±9,5
Semivasca ☺

TULIPANO CARRARA



portafiori
vasche
lampade

porte-fleurs
vases
lampes

vases
and lamps

bucaros
jardineras
lamparas

blumenvasen
schalen
lampen



P 9 076/20
cm ±20x14,5±7,5
Semilampada ☺



P 4 581/19 D
cm ±19x18,5±9
Semivasca ☺

cinerari
ed ossari

vases et
lampes pour
colombarium

accessories
for ossuaries

oasarios

zubehör
für ossarium



CINERARI E OSSARI CARRARA



P 7 709/13
cm ±13x7,±6



P 1 117/13R
cm ±13x8,±7,5



P 7 253/15
cm ±15x7,±6,5
I 7 255/15
cm ±15x7,±4x3,5



P 2 101/13
cm ±13x8,±7,5
I 2 112/13
cm ±13x8,±4,5x3,5



P 7 125/15
cm ±15x7,±7



P 1 124/13P
cm ±13x7,±7



P 7 137/14
cm ±14x7,±7,5



P 1 152/13P
cm ±13x7,±7,5



P 9 128/13
cm ±13,5x5,5,±6,5



P 4 695/13P
cm ±13x6,±7

PORTA ORCHIDEA



P 2 931/10
cm ±11x3,5,±4



P 2 956/12P
cm ±12x4,5,±3,5



P 2 977/12
cm ±12x5,±3



P 2 951/12
cm ±12,5x4,±4

con perni e biadesivo

con perni e biadesivo

con perni

CORNICI CARRARA



cornici cadres frames portarretratos bilderrahmen



- P 19 125/09** cm 9x12
- P 19 125/11** cm 11x15
- P 19 125/13** cm 13x18



- P 21 185/09** cm 9x12
- P 21 185/10** cm 10x15
- P 21 185/11** cm 11x15
- P 21 185/13** cm 13x18



- P 19 886/09** cm 9x12
- P 19 886/11** cm 11x15
- P 19 886/13** cm 13x18



- P 21 641/09** cm 9x12
- P 21 641/10** cm 10x15
- P 21 641/11** cm 11x15
- P 21 641/13** cm 13x18



- P 19 361/05** cm 5x7
- P 19 361/06** cm 6x8
- P 19 361/07** cm 7x9
- P 19 361/08** cm 8x10
- P 19 361/09** cm 9x12
- P 19 361/11** cm 11x15
- P 19 361/13** cm 13x18



- P 21 219/08** cm 8x10
- P 21 219/09** cm 9x12
- P 21 219/10** cm 10x15
- P 21 219/11** cm 11x15
- P 21 219/13** cm 13x18



- P 19 305/09** cm 9x12
- P 19 305/11** cm 11x15
- Sporgente



- P 21 230/09** cm 9x12
- P 21 230/10** cm 10x15
- P 21 230/11** cm 11x15
- Sporgente



- P 19 760/08** cm 8x10
- P 19 760/09** cm 9x12
- P 19 760/11** cm 11x15
- P 19 760/13** cm 13x18



- P 21 024/08** cm 8x10
- P 21 024/09** cm 9x12
- P 21 024/10** cm 10x15
- P 21 024/11** cm 11x15
- P 21 024/13** cm 13x18



- P 19 019/09** cm 9x12
- P 19 019/11** cm 11x15
- P 19 019/13** cm 13x18



- P 21 009/09** cm 9x12
- P 21 009/10** cm 10x15
- P 21 009/11** cm 11x15
- P 21 009/13** cm 13x18



- P 19 539/09** cm 9x12
- P 19 539/11** cm 11x15
- P 19 539/13** cm 13x18
- Con filetto Inox



- P 21 476/09** cm 9x12
- P 21 476/10** cm 10x15
- P 21 476/11** cm 11x15
- P 21 476/13** cm 13x18
- Con filetto Inox



TARGHE CARRARA



Cristo

- P 31 690/13** cm ±13x9
- P 31 690/18** cm ±18x12,5
- P 31 690/26** cm ±26x18,5



Cristo

- P 31 039/14** cm ±14x11
- P 31 039/20** cm ±20x16



S.Pio

- P 31 013/14** cm ±14x10



Madonna

- P 31 670/13** cm ±13x10
- P 31 670/18** cm ±18x13
- P 31 670/26** cm ±26x19,5



Pietà

- P 31 108/18** cm ±18x13
- P 31 108/26** cm ±26x19

Accessori

Specificare sempre all'ordine il tipo di carattere: **Corsivo, Bastone o Romano**
Le incisioni non sono comprese nel prezzo.
Le applicazioni e le incisioni non sono comprese nel prezzo.
Incisione alla lettera (oltre le 40 lettere, sconto 50%)



- P 22 415/70** cm ±7x10
- P 22 415/100** cm ±10x15
- P 22 415/110** cm ±11x20
- P 22 415/150** cm ±15x22
- P 22 415/180** cm ±18x27

Pergamena Carrara con incisioni a richiesta

Le incisioni possono essere in carattere Corsivo, Bastone o Romano.
Les gravures peuvent être réalisées soit en caractères cursifs soit en caractères bâtons, Romano.

Las grabaciones pueden ser en carácter corsivo, bastón ó Romano

Engravings may be in Cursive, Block or Romano letters.

Die Gravierungen können sowohl in Kursivschrift als auch in Druckschrift ausgeführt werden, Romano.

CROCI CARRARA



croci

croix

crosseses

cruces

kreuze



- P 23 344/15** cm ±15x8
- P 23 344/20** cm ±20x10
- P 23 344/25** cm ±25x12
- P 23 344/30** cm ±30x14
con Cristo Carrara



- P 30 060/13** cm ±13x10
- P 30 060/17** cm ±17x12
- P 30 060/26** cm ±26x19
- P 30 060/37** cm ±37x26



- P 23 046/15** cm ±15x8
- P 23 046/20** cm ±20x10
- P 23 046/25** cm ±25x12
- P 23 046/30** cm ±30x14
con Cristo in bronzo



- P 24 239/15** cm ±15x7
- P 24 239/20** cm ±20x8,5
- P 24 239/25** cm ±25x11
- P 24 239/30** cm ±30x13



- P 24 268/15** cm ±15x7
- P 24 268/20** cm ±20x8,5
- P 24 268/25** cm ±25x11
- P 24 268/30** cm ±30x13
- P 24 268/40** cm ±40x16



- P 23 297/12** cm ±12x6,5
- P 23 297/15** cm ±15x8
- P 23 297/20** cm ±20x10
- P 23 297/25** cm ±25x12
- P 23 297/30** cm ±30x14

lampade
elettriche
incassate

lampes
électriques
à encastrer

built-in
electric
lamps

lampara
eléctrica para
incrustar

elektrische
einbaulampen



LAMPADE ELETTRICHE INCASSATE CARRARA



Portina cristallo

■ 13 205/06 cm 4,5xØ6

■ 13 205/08 cm 5,5xØ8

■ 13 205/12 cm 6,5xØ12



Portina cristallo

■ 13 220/08 cm 3,5xØ8



Portina cristallo

■ 13 235/08 cm 3,5xØ8
Cristallo con iridescenza



Portina cristallo

■ 13 141/06 cm 2,5xØ6

■ 13 141/08 cm 2,5xØ8

■ 13 141/10 cm 2,5xØ10

■ 13 141/12 cm 3xØ12



Portina cristallo

■ 13 190/06 cm 4xØ6

■ 13 190/08 cm 5xØ8

■ 13 190/12 cm 6xØ12

INCASSI CARRARA



incassi vases et insert vases incrustados versenkbare
lamps lampes and lamps for para monumentos vase und
encastrables monuments monumentos lampen



I 13 021/10P Ø cm ±10x16



I 13 442/11R Ø cm ±11x17

I 13 442/11P Ø cm ±11x17



I 13 060/09 Ø cm ±9x16



I 13 650/21 cm ±21x12, ±Ø9



P 12 047/11 Ø cm ±11x16, ±12

I 12 046/11 Ø cm ±11x16, ±Ø11

BORCHIE CARRARA



Cabochons avec une fonction essentiellement decorative Studs prevalently for decorative use Clavos prevalentemente decorativos Beschläge mit vorwiegend dekorativer funktion

Borchie Carrara con funzione prevalentemente decorativa



26 110/45 Ø cm 4,5
perno 5 MA x 60



26 032/30 cm 3x3
26 032/40 cm 4x4
perno 5 MA x 60



26 076/830 Ø cm 3
26 076/855 Ø cm 5,5
perno 8 MA x 90



Tipo Parma
26 185/30 Ø cm 3
26 185/55 Ø cm 5,5
perno 8 MA in acciaio inox



GHIERE CARRARA



Diametro cm 6

9 908/03 cm ±17,↔ø8
con fiamma

9 902/03 cm ±3,↔ø8
senza fiamma



Diametro cm 5

9 931/03 cm ±13,↔ø6,5
con fiamma

9 946/03 cm ±2,5,↔ø6,5
senza fiamma



Diametro cm 5 Ribassata

9 950/0 cm ±13,↔ø6
con fiamma

9 949/0 cm ±1,5,↔ø6
senza fiamma



Diametro cm 4

9 954/02 cm ±10,↔ø6
con fiamma

9 940/02 cm ±2,↔ø6
senza fiamma

Per i caratteri in finitura carrara, vedi sezione caratteri da pag. 262

CACCIATI



VERDE ALPI

portafiori
vasche
lampade

porte-fleurs
vases
lampes

vases
and lamps

bucaros
jardineras
lamparas

blumenvasen
schalen
lampen



OLIMPIA VERDE ALPI

Designed by Gianluca Ugoletti



P 2 191/19 ⓘ
cm ±19x13,±12

P 2 580/18 ⓘ
cm ±18x18,5,±12

P 9 519/20
cm ±20x11,±9,5



P 24 270/12 cm ±12x6,5
P 24 270/15 cm ±15x8
P 24 270/20 cm ±20x10



P 19 770/08 cm 8x10
P 19 770/09 cm 9x12
P 19 770/11 cm 11x15

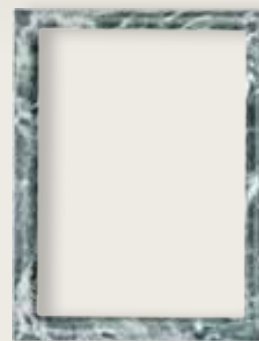

P 21 032/08 cm 8x10
P 21 032/09 cm 9x12
P 21 032/10 cm 10x15
P 21 032/11 cm 11x15

VENUS VERDE ALPI

Designed by Gianluca Ugoletti



portafiori
vasche
lampade

porte-fleurs
vases
lampes

vases
and lamps

bucaros
jardineras
lamparas

blumenvasen
schalen
lampen



P 1 530/20R ◉
cm ±19,5x11,5,±10,5

I 1 535/20R ◉
cm ±19,5x11,5,±6,5x6

P 7 064/20
cm ±20x10,±9

I 7 093/20
cm ±20x10,±6x5,5

P 1 538/19R ◉
cm ±18,5x17,±11,5

I 1 543/19R ◉
cm ±18,5x17,±11x7

CINERARI E OSSARI



P 1 530/13P ◉
cm ±13x7,±7



P 7 064/15
cm ±15x7,±7

portafiori
vasche
lampade

porte-fleurs
vases
lampes

vases
and lamps

bucaros
jardineras
lamparas

blumenvasen
schalen
lampen



TULIPANO VERDE ALPI



P 9 070/20
cm :20x14,5x7,5
Semilampada ☺



P 4 590/20 Ⓢ
cm :19x18,5x9
Semivasca ☺



P 24 270/12 cm :12x6,5
P 24 270/15 cm :15x8
P 24 270/20 cm :20x10



P 19 770/08 cm 8x10
P 19 770/09 cm 9x12
P 19 770/11 cm 11x15

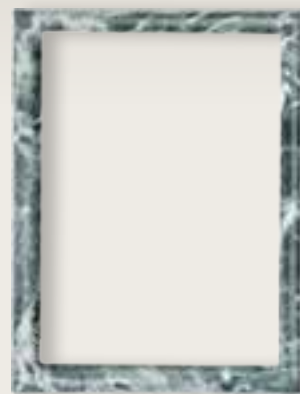

P 21 032/08 cm 8x10
P 21 032/09 cm 9x12
P 21 032/10 cm 10x15
P 21 032/11 cm 11x15



UNIBLANC



OLMO UNIBLANC

Designed by Alessandro Asti



portafiori
vasche
lampade

porte-fleurs
vases
lampes

vases
and lamps

bucaros
jardineras
lamparas

blumenvasen
schalen
lampen



P 1 073/20R
cm 20x13,2x11

I 1 085/20R
cm 20x13,2x6x5,5

P 7 129/19
cm 19x11,2x9,5

I 7 141/19
cm 19x11,2x5,5x4,5

P 2 120/18R
cm 18x18,2x12

I 2 144/18R
cm 18x18,2x6,5x12

CINERARI E OSSARI



P 7 129/16
cm 16x8,2x7

P 1 073/13P
cm 13x8,2x7,5

P 21 062/08
cm 8x10

P 19 070/08
cm 8x10



P 24 190/15
cm 15x7



P 19 033/09
cm 9x12



P 21 038/09
cm 9x12

P 24 190/20
cm 20x8,5

P 19 033/11
cm 11x15

P 21 038/11
cm 11x15

P 24 190/25
cm 25x11

portafiori
vasche
lampade

porte-fleurs
vases
lampes

vases
and lamps

bucaros
jardineras
lamparas

blumenvasen
schalen
lampen



FIORE LINE UNIBLANC



P 1 011/21P
cm :21x11,5,~11,5

P 7 118/19
cm :19x9,~8,5

P 2 113/18P
cm :18,5x19,~14

CINERARI E OSSARI

SEMIVASO



I 13 009/10P
cm :10x16



P 1 452/13
cm :14x7,~4

P 1 452/21
cm :21x11,5,~6



P 2 904/12P
cm :12x4,5,~3,5



P 7 118/14
cm :14x7,~7,5



P 1 011/13P
cm :13x7,~7,5

Con perni
e biadesivo

LE CANTARE

UNIBLANC



portafiori
vasche
lampade

porte-fleurs
vases
lampes

vases
and lamps

bucaros
jardineras
lamparas

blumenvasen
schalen
lampen



P 5 972/19R
cm ±19,5x11,±11,5

T 5 983/19R
cm ±19,5x11,±ø8



P 9 195/19
cm ±19,5x9,±9

T 9 203/19
cm ±19,5x9,±ø4,5



P 4 895/18R
cm ±18,5x17,±11,5

T 4 903/18R
cm ±18,5x17,±9,5x5



P 19 123/09 cm 9x12

P 19 123/11 cm 11x15

P 19 123/13 cm 13x18



P 21 183/09 cm 9x12

P 21 183/10 cm 10x15

P 21 183/11 cm 11x15

P 21 183/13 cm 13x18

portafiori
vasche
lampade

porte-fleurs
vases
lampes

vases
and lamps

bucaros
jardineras
lamparas

blumenvasen
schalen
lampen



DANUBIO UNIBLANC

Designed by Gianluca Ugoletti



P 2 153/20R

cm :20x13,2-12

T 2 155/20R

cm :20x13,2-ø6,5

P 7 244/21
cm :21x10,2-9

T 7 246/21

cm :21x10,2-ø5,5

P 2 157/19R

cm :19x18,5-11,5

T 2 159/19R

cm :19x18,5-12x6



P 10 577/19
cm :19x12,2-12,5

T 10 579/19
cm :19x12,2-7x7

CINERARI E OSSARI



P 7 244/15
cm :15x7,2-6,5



P 2 153/13R

cm :13x8,2-7,5

ATHENEAE UNIBLANC ORO

Designed by Gianluca Ugoletti



portafiori
vasche
lampade

porte-fleurs
vases
lampes

vases
and lamps

bucaros
jardineras
lamparas

blumenvasen
schalen
lampen



P 5 312/20
cm ±20x10,5,±11,5

I 5 323/20
cm ±20x10,5,±ø6



P 9 533/18
cm ±18x8,5,±9

I 9 542/18
cm ±18x8,5,±ø5



P 5 332/16
cm ±17x16,±12

I 5 341/16
cm ±17x16,±11,5x6,5

CINERARI E OSSARI



P 9 533/15
cm ±14,5x6,5,±7



P 5 312/13
cm ±13x7,±7,5



P 19 534/09 cm 9x12

P 19 534/11 cm 11x15

P 19 534/13 cm 13x18



P 21 477/09 cm 9x12

P 21 477/10 cm 10x15

P 21 477/11 cm 11x15

P 21 477/13 cm 13x18

portafiori
vasche
lampade

porte-fleurs
vases
lampes

vases
and lamps

bucaros
jardineras
lamparas

blumenvasen
schalen
lampen



GRAZIA UNIBLANC ORO

Designed by Gianluca Ugoletti



P 2 238/20R
cm ±20x11,5↔12

I 2 247/20R
cm ±20x11,5↔ø6,5



P 9 025/21
cm ±21x10↔10,5

I 9 047/21
cm ±21x10↔ø6



P 4 257/19R
cm ±19x17,5↔11,5

I 4 268/19R
cm ±19x17,5↔12x6



P 19 534/09 cm 9x12

P 19 534/11 cm 11x15

P 19 534/13 cm 13x18



P 21 477/09 cm 9x12

P 21 477/10 cm 10x15

P 21 477/11 cm 11x15

P 21 477/13 cm 13x18

SELENE UNIBLANC

Designed by Gianluca Ugoletti



portafiori
vasche
lampade

porte-fleurs
vases
lampes

vases
and lamps

bucaros
jardineras
lamparas

blumenvasen
schalen
lampen





P 4 213/20 
cm ±19,5x12,5, ±10,5

T 4 225/20 
cm ±20x12,5, ±7x5,5

P 9 253/19
cm ±19,5x11, ±8

T 9 264/19
cm ±20x11, ±6x3,5

P 4 235/17 
cm ±17x19, ±9,5

T 4 246/17 
cm ±17,5x19, ±8x4



P 9 297/17
cm ±17x16,5, ±8

T 9 229/17
cm ±17,5x16,5, ±6x3



P 19 534/09 cm 9x12

P 19 534/11 cm 11x15

P 19 534/13 cm 13x18



P 21 477/09 cm 9x12

P 21 477/10 cm 10x15

P 21 477/11 cm 11x15

P 21 477/13 cm 13x18



P 9 218/17
cm ±17x16,5, ±8

T 9 229/17
cm ±17,5x16,5, ±6x3

portafiori
vasche
lampade

porte-fleurs
vases
lampes

vases
and lamps

bucaros
jardineras
lamparas

blumenvasen
schalen
lampen



LINDA UNIBLANC



P 6 605/20P
cm ±20x12,±11

T 6 606/20P
cm ±20x12,±07



P 9 845/19
cm ±19x10,5,±8,5

T 9 846/19
cm ±19x10,5,±05,5



P 6 709/17P
cm ±17x19,±12

T 6 710/17P
cm ±17x19,±10x6,5



P 19 123/09 cm 9x12

P 19 123/11 cm 11x15

P 19 123/13 cm 13x18



P 21 183/09 cm 9x12

P 21 183/10 cm 10x15

P 21 183/11 cm 11x15

P 21 183/13 cm 13x18



P 11 133/18
cm ±18x14,±12,5

T 11 146/18
cm ±18x14,±07

ANTICA UNIBLANC

Designed by Gianluca Ugoletti



portafiori
vasche
lampade

porte-fleurs
vases
lampes

vases
and lamps

bucaros
jardineras
lamparas

blumenvasen
schalen
lampen



P 2 349/20P

cm :20x11,5,~12

T 2 405/20P

cm :20x11,5,~ø6,5



P 9 121/21

cm :21x10,~10,5

T 9 143/21

cm :21x10,~ø6



P 4 359/19P

cm :19x17,5,~11,5

T 4 365/19P

cm :19x17,5,~12x6



T 12 826/11

cm :11x16,~ø11



T 12 835/12

cm :12x23,~ø18,5



T 13 639/21

cm :21x12,~ø9



T 13 045/09

cm :9x16



T 12 117/12

cm :12x23

portafiori
vasche
lampade

porte-fleurs
vases
lampes

vases
and lamps

bucaros
jardineras
lamparas

blumenvasen
schalen
lampen



GIADA UNIBLANC

Designed by Gianluca Ugoletti



P 7 003/20
cm $\pm 20 \times 12,2 \times 9$
Semilampada ☺



P 4 015/20P $\text{\textcircled{P}}$
cm $\pm 20 \times 15,5 \times 9$
Semivaso ☺



P 4 204/18 $\text{\textcircled{P}}$
cm $\pm 18 \times 26,2 \times 9,5$
Semivasca ☺



P 19 123/09 cm 9x12
P 19 123/11 cm 11x15
P 19 123/13 cm 13x18



P 21 183/09 cm 9x12
P 21 183/10 cm 10x15
P 21 183/11 cm 11x15
P 21 183/13 cm 13x18



P 11 055/18
cm $\pm 18 \times 14,2 \times 11$



P 4 315/17 $\text{\textcircled{P}}$
cm $\pm 17 \times 45,5 \times 10$
Semivasca ☺

La serie è predisposta per l'applicazione sia a parete che a terreno

FIORE LINE

UNIBLANC



portafiori
vasche
lampade

porte-fleurs
vases
lampes

vases
and lamps

bucaros
jardineras
lamparas

blumenvasen
schalen
lampen



P 9 237/21
cm ±21,5x11,5,±8
Semilampada ☺



P 4 607/21
cm ±20,5x18,±9,5
Semivasca ☺

TULIPANO

UNIBLANC



portafiori
vasche
lampade

porte-fleurs
vases
lampes

vases
and lamps

bucaros
jardineras
lamparas

blumenvasen
schalen
lampen



P 9 074/20
cm ±20x14,5,±7,5
Semilampada ☺

P 4 578/19
cm ±19x18,5,±9
Semivasca ☺



P 9 075/20
cm ±20x14,5,±7,5
Con filetto bronzo
Semilampada ☺

P 4 579/19
cm ±19x18,5,±9
Con filetto bronzo
Semilavasca ☺



CORNICI UNIBLANC



P 19 033/09 cm 9x12
P 19 033/11 cm 11x15



P 21 038/09 cm 9x12
P 21 038/11 cm 11x15



P 21 062/08 cm 8x10



P 19 070/08 cm 8x10



P 19 123/09 cm 9x12
P 19 123/11 cm 11x15
P 19 123/13 cm 13x18



P 21 183/09 cm 9x12
P 21 183/10 cm 10x15
P 21 183/11 cm 11x15
P 21 183/13 cm 13x18



P 19 826/09 cm 9x12
P 19 826/11 cm 11x15
P 19 826/13 cm 13x18



P 19 534/09
cm 9x12
P 19 534/11
cm 11x15
P 19 534/13
cm 13x18
con filetto dorato



P 21 477/09
cm 9x12
P 21 477/10
cm 10x15
P 21 477/11
cm 11x15
P 21 477/13
cm 13x18
con filetto dorato



P 19 352/08
cm 8x10
P 19 352/09
cm 9x12
P 19 352/11
cm 11x15
P 19 352/13
cm 13x18
P 19 352/18
cm 18x24



P 21 217/08
cm 8x10
P 21 217/09
cm 9x12
P 21 217/10
cm 10x15
P 21 217/11
cm 11x15
P 21 217/13
cm 13x18
P 21 217/18
cm 18x24

CROCI UNIBLANC



comici cadres frames portarretratos bilderrahmen



- P 23 295/12** cm ±12x6,5
- P 23 295/15** cm ±15x8
- P 23 295/20** cm ±20x10
- P 23 295/25** cm ±25x12
- P 23 295/30** cm ±30x14



- P 24 257/15** cm ±15x7
- P 24 257/20** cm ±20x8,5
- P 24 257/25** cm ±25x11
- P 24 257/30** cm ±30x13
con fregio dorato



- P 24 190/15** cm 15x7
- P 24 190/20** cm 20x8,5
- P 24 190/25** cm 25x11



- P 23 342/20** cm ±20x8
- P 23 342/30** cm ±30x12,5
- P 23 342/40** cm ±40x16



- P 23 023/15** cm ±15x8
- P 23 023/20** cm ±20x10
- P 23 023/25** cm ±25x12
- P 23 023/30** cm ±30x14
con Cristo dorato



L'altezza indicata per l'articolo **24 302** è quella massima. La misura è riducibile fino ad un massimo di cm 9 semplicemente posizionando il tronco della croce sulle tacche già predisposte sul piede di sostegno.

- P 24 302/69**
cm ±69x25,5x±12,5
con fregio dorato



TARGHE UNIBLANC



Cristo

P 31 035/14
cm ±14x11

P 31 035/20
cm ±20x16



Cristo

P 31 675/13
cm ±13x9

P 31 675/18
cm ±18x12,5

P 31 675/26
cm ±26x18,5



Madonna

P 32 696/20
cm ±20x11



Madonna con bambino

P 32 685/18
cm ±18x13



Madonna

P 31 664/13
cm ±13x10

P 31 664/18
cm ±18x13

P 31 664/26
cm ±26x19,5



Pietà

P 31 106/18 cm ±18x13

P 31 106/26 cm ±26x19



Pietà

P 31 536/19 cm ±19x16,5-4

P 31 536/26 cm ±26x22-5



Angelo

P 31 648/21 cm ±20x11

P 31 648/25 cm ±25x14



Angelo

P 31 659/21 cm ±20x11

P 31 659/25 cm ±25x14



Cristo

P 32 961/17
cm ±17x13



Madonna

P 32 963/17
cm ±17x13



P 30 058/13
cm ±13x10

P 30 058/17
cm ±17x12

P 30 058/26
cm ±26x19

P 30 058/37
cm ±37x26

CINERARI E OSSARI UNIBLANC



cinerari
ed ossari

vases et
lampes pour
colombarium

accessories
for ossuaries

oasarios

zubehör
für ossarium



P 7 129/16
cm ±16x8,7



P 1 073/13P D
cm ±13x8,7,5



P 7 118/14
cm ±14x7,7,5



P 1 011/13P D
cm ±13x7,7,5



P 9 533/15
cm ±14,5x6,5,7



P 5 312/13 D
cm ±13x7,7,5



P 7 244/15
cm ±15x7,6,5



P 2 153/13R D
cm ±13x8,7,5

PORTAORCHIDEA



P 2 904/12P D
cm ±12x4,5,3,5
Con perni e biadesivo



P 2 927/12
cm ±11x3,5,4
con anello dorato



P 2 942/12 D
cm ±12x5,3
con perni e biadesivo



P 2 957/12 D
cm ±12,5x4,4
con perni e biadesivo

incassi vases et
lampes
encastrables

insert vases
and lamps for
monuments

incrustados
para
monumentos

versenkbare
vase und
lampen



INCASSI UNIBLANC



13 639/21
cm ±21x12↔ø9



13 045/09 ⓘ
cm ±9x16



12 117/12 ⓘ
cm ±12x23



13 009/10P ⓘ
cm ±10x16

ghiere embouts
reductions

ring nuts

lamparas

kranze



GHIERE UNIBLANC



Diametro cm 4

9 875/10
cm ±10↔ø6 con fiamma

9 933/02
cm ±2↔ø6 senza fiamma



Diametro cm 5

9 839/13
cm ±13↔ø6,5 con fiamma

9 932/03
cm ±2,5↔ø6,5 senza fiamma



Diametro cm 6

9 815/17
cm ±17↔ø8 con fiamma

9 907/03
cm ±3↔ø8 senza fiamma

STAFFE UNIBLANC



Etriers pour les soutiens des enfeux d'épaisseur variable

Brackets for niches support with variable thickness

Garras para sostener lapidas de espesor variable

Grabstein-stützhalter mit verstellbarer dichte

Staffe con finitura Uniblanc, per sostegno lapidi a spessore variabile

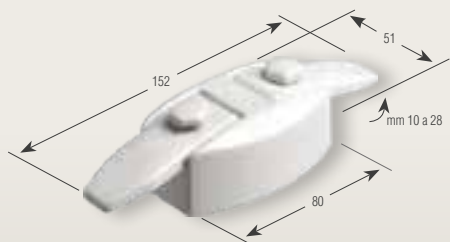

27 325/10
≙ cm 1 a 2,8
perno 8 MA

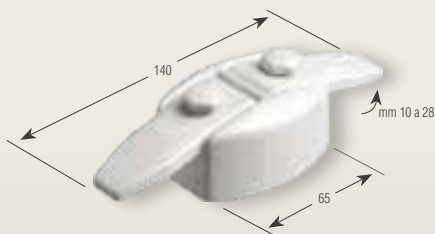

27 318/10
≙ cm 1 a 2,8
perno 8 MA

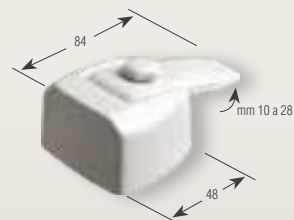

27 307/10
≙ cm 1 a 2,8
perno 8 MA

Perni in acciaio inox compresi nel prezzo.

Pivots en acier inox compris dans le prix.

Stainless steel pivots included in price.

Pernios en acero inox incluidos en precio.

Bolzen aus rostfreiem Stahl im Preis einschliesslich.



27 318/00
≙ cm 0 a 1,5
perno 6 MA



27 307/00
≙ cm 0 a 1,5
perno 6 MA

A richiesta sarà fornita la documentazione tecnica relativa alla portata massima

BORCHIE UNIBLANC



Cabochons avec une fonction essentiellement decorative

Studs prevalently for decorative use

Clavos prevalentemente decorativos

Beschläge mit vorwiegend dekorativer funktion

Borchie Uniblanc con funzione prevalentemente decorativa



26 101/45 ø cm 4,5
perno 5 MA x 60



26 031/30 cm 3x3
26 031/40 cm 4x4
perno 5 MA x 60



26 073/30 ø cm 3
26 073/55 ø cm 5,5
perno 5 MA x 60



Pergamena per incisioni a richiesta

Le incisioni possono essere in carattere Corsivo, Bastone o Romano.

Les gravures peuvent être réalisées soit en caractères Cursif soit en caractères Bâtons, Romano.

Engravings may be in Cursive, Block, or Romano letters.

Las grabaciones pueden ser en carácter Corsivo, Bastón ó Romano.

Die Prägungen können in Schreibschrift, in Bastone oder Romano sein.



Specificare sempre all'ordine il tipo di carattere: **Corsivo, Bastone o Romano**
Le applicazioni e le incisioni non sono comprese nel prezzo.
Incisione alla lettera (oltre le 40 lettere, sconto 50%)

P 22 413/70 cm ±7x10
P 22 413/100 cm ±10x15
P 22 413/110 cm ±11x20

P 22 413/150 cm ±15x22
P 22 413/180 cm ±18x27

Lampada con pannello solare



T 11 782/19
cm ±19x12,↔7x7

T 11 782/24
cm ±24,5x15,↔8,5x8,5

Per i caratteri in finitura uniblanco, vedi sezione caratteri da pag. 262.

CAGGIATI



DARK

portafiori
vasche
lampade

porte-fleurs
vases
lampes

vases
and lamps

bucaros
jardineras
lamparas

blumenvasen
schalen
lampen



VENUS DARK

Designed by Gianluca Ugoletti



P 1 140/20R
cm ±19,5x11,5,±10,5

I 1 145/20R
cm ±19,5x11,5,±6,5x6

P 7 075/20
cm ±20x10,±9

I 7 088/20
cm ±20x10,±6x5,5

P 1 148/19R
cm ±18,5x17,±11,5

I 1 150/19R
cm ±18,5x17,±11x7



P 19 780/06 cm 6x8

P 19 780/07 cm 7x9

P 19 780/08 cm 8x10

P 19 780/09 cm 9x12

P 19 780/11 cm 11x15

P 19 780/13 cm 13x18

P 19 780/18 cm 18x24



P 21 028/07 cm 7x9

P 21 028/08 cm 8x10

P 21 028/09 cm 9x12

P 21 028/10 cm 10x15

P 21 028/11 cm 11x15

P 21 028/13 cm 13x18

P 21 028/18 cm 18x24

CINERARI E OSSARI



P 7 075/15
cm ±15x7,±7



P 1 140/13P
cm ±13x7,±7

ATHENEAE DARK

Designed by Gianluca Ugoletti



portafiori
vasche
lampade

porte-fleurs
vases
lampes

vases
and lamps

bucaros
jardineras
lamparas

blumenvasen
schalen
lampen



P 5 553/20 ●
cm ±20x10,5,±11,5

I 5 564/20 ●
cm ±20x10,5,±10,6



P 9 659/18
cm ±18x8,5,±9

I 9 661/18
cm ±18x8,5,±10,5



P 5 575/16 ●
cm ±17x16,±12

I 5 586/16 ●
cm ±17x16,±11,5x6,5



P 19 617/09
cm 9x12

P 19 617/11
cm 11x15

P 19 617/13
cm 13x18



P 21 518/09
cm 9x12

P 21 518/10
cm 10x15

P 21 518/11
cm 11x15

P 21 518/13
cm 13x18

portafiori
vasche
lampade

porte-fleurs
vases
lampes

vases
and lamps

bucaros
jardineras
lamparas

blumenvasen
schalen
lampen



ATHENEAE DARK

CINERARI E OSSARI



P 9 659/15
cm ±14,5x6,5x7



P 5 553/13 ⓘ
cm ±13x7,2x7,5



P 2 971/10
cm ±11x3,5x4
con anello dorato



P 11 915/17
cm ±17,5x12,2x11,5

T 11 926/17
cm ±17,5x12,2x8



T 13 804/21
cm ±21x11,2x8,5



T 13 405/95 ⓘ
cm ±9,5x16



T 9 661/26
cm ±26x11,5x8,5



T 5 564/28 ⓘ
cm ±28x14,2x8,5



T 11 926/24
cm ±26x15,2x9

GRAZIA DARK

Designed by Gianluca Ugoletti



portafiori
vasche
lampade

porte-fleurs
vases
lampes

vases
and lamps

bucaros
jardineras
lamparas

blumenvasen
schalen
lampen



P 2 240/20R ◉
cm ±20x11,5,±12

T 2 257/20R ◉
cm ±20x11,5,±ø6,5



P 9 020/21
cm ±21x10,±10,5

T 9 039/21
cm ±21x10,±ø6



P 4 254/19R ◉
cm ±19x17,5,±11,5

T 4 269/19R ◉
cm ±19x17,5,±12x6



P 19 617/09 cm 9x12

P 19 617/11 cm 11x15

P 19 617/13 cm 13x18



P 21 518/09 cm 9x12

P 21 518/10 cm 10x15

P 21 518/11 cm 11x15

P 21 518/13 cm 13x18



T 13 628/21
cm ±21x12,±ø9



T 13 030/09R ◉
cm ±9x16

portafiori
vasche
lampade

porte-fleurs
vases
lampes

vases
and lamps

bucaros
jardineras
lamparas

blumenvasen
schalen
lampen



ANTICA DARK

Designed by Gianluca Ugoletti



P 2 350/20R

cm ±20x11,5,±12

T 2 407/20R

cm ±20x11,5,±ø6,5



P 9 127/21

cm ±21x10,±10,5

T 9 153/21

cm ±21x10,±ø6



P 4 360/19R

cm ±19x17,5,±11,5

T 4 370/19R

cm ±19x17,5,±12x6



P 19 360/09 cm 9x12

P 19 360/11 cm 11x15



P 21 216/09 cm 9x12

P 21 216/10 cm 10x15

P 21 216/11 cm 11x15



T 13 638/21

cm ±21x12,±ø9



T 13 040/09R

cm ±9x16

TULIPANO

DARK



portafiori
vasche
lampade

porte-fleurs
vases
lampes

vases
and lamps

bucaros
jardineras
lamparas

blumenvasen
schalen
lampen



P 9 095/20
cm :20x14,5,7,5



P 4 580/20 ⓘ
cm :19x18,5,9



P 19 617/09 cm 9x12
P 19 617/11 cm 11x15
P 19 617/13 cm 13x18



P 21 518/09 cm 9x12
P 21 518/10 cm 10x15
P 21 518/11 cm 11x15
P 21 518/13 cm 13x18



P 9 088/20
cm :20x14,5,7,5



P 4 568/20 ⓘ
cm :19x18,5,9

ossari

vases et
lampes pour
colombarium

accessories
for ossuaries

osarios

zubehor fur
ossarium



OSSARI DARK

CINERARI E OSSARI



P 7 075/15
cm :15x7,2x7



P 1 140/13P
cm :13x7,2x7

CINERARI E OSSARI



P 9 659/15
cm :14,5x6,5x7



P 5 553/13
cm :13x7,2x7,5



P 2 971/10
cm :11x3,5x4
con anello dorato

cornici

cadres

frames

portarretratos

bilderrahmen



CORNICI DARK



- P 19 780/06** cm 6x8
- P 19 780/07** cm 7x9
- P 19 780/08** cm 8x10
- P 19 780/09** cm 9x12
- P 19 780/11** cm 11x15
- P 19 780/13** cm 13x18
- P 19 780/18** cm 18x24



- P 19 360/09** cm 9x12
- P 19 360/11** cm 11x15



- P 19 617/09** cm 9x12
- P 19 617/11** cm 11x15
- P 19 617/13** cm 13x18



- P 21 028/07** cm 7x9
- P 21 028/08** cm 8x10
- P 21 028/09** cm 9x12
- P 21 028/10** cm 10x15
- P 21 028/11** cm 11x15
- P 21 028/13** cm 13x18
- P 21 028/18** cm 18x24



- P 21 216/09** cm 9x12
- P 21 216/10** cm 10x15
- P 21 216/11** cm 11x15



- P 21 518/09** cm 9x12
- P 21 518/10** cm 10x15
- P 21 518/11** cm 11x15
- P 21 518/13** cm 13x18

INCASSI DARK



incassi vases et insert vases incrustados versenkbare
lamps and lamps for and lamps for para vase und
encastrables monuments monumetos lampen



I 13 804/21
cm ±21x11, ±ø6,5



I 13 405/95
cm ±9,5x16



I 13 628/21
cm ±21x12, ±ø9



I 13 030/09R
cm ±9x16



I 13 638/21
cm ±21x12, ±ø9



I 13 040/09R
cm ±9x16

CROCI DARK



croci croix crosseses cruces kreuze



P 24 807/15 cm ±15x8

P 24 807/20 cm ±20x10

P 24 807/25 cm ±25x12

P 24 807/30 cm ±30x14

P 24 807/35 cm ±35x16



P 24 259/15 cm ±15x7

P 24 259/20 cm ±20x8,5

P 24 259/25 cm ±25x11

P 24 259/30 cm ±30x13

P 24 259/40 cm ±40x16

Con fregio dorato



P 24 317/50 cm ±50x25,5

GHIERE DARK



ghiere embouts ring nuts lamparas kranze
reductions



Diametro cm 4

I 9 873/10
cm ±10, ±ø6 con fiamma

I 9 918/02
cm ±2, ±ø6 senza fiamma



Diametro cm 5

I 9 916/13
cm ±13, ±ø6,5 con fiamma

I 9 836/03
cm ±2,5, ±ø6,5 senza fiamma



Diametro cm 6

I 9 812/17
cm ±17, ±ø8 con fiamma

I 9 906/03
cm ±3, ±ø8 senza fiamma

Lampada con pannello solare



I 11 783/19
cm ±19x12, ±7x7

I 11 783/24
cm ±24,5x15, ±8,5x8,5

Etriers pour les soutien des enfeux d'épaisseur variable

Brackets for niches support with variable thickness

Garras para sostener lapidas de espesor variable

Grabstein-stützhalter mit verstellbarer dichte



STAFFE DARK

Staffe Dark per sostegno lapidi a spessore variabile

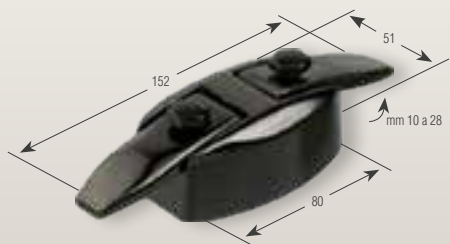

27 526/10
≙ cm 1 a 2,8
perno 8 MA

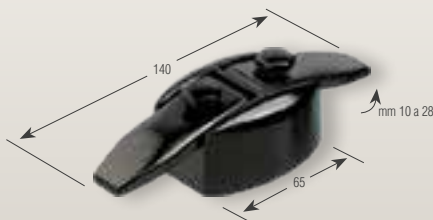

27 515/10
≙ cm 1 a 2,8
perno 8 MA



27 504/10
≙ cm 1 a 2,8
perno 8 MA

Perni in acciaio inox compresi nel prezzo.

Pivots en acier inox compris dans le prix.

Stainless steel pivots included in price.

Pernios en acero inox incluidos en precio.

Bolzen aus rostfreiem Stahl im Preis einschliesslich.



27 515/00
≙ cm 0 a 1,5
perno 6 MA



27 504/00
≙ cm 0 a 1,5
perno 6 MA

A RICHIESTA sarà fornita la documentazione tecnica relativa alla portata massima

Cabochons avec une fonction essentiellement decorative

Studs prevalently for decorative use

Clavos prevalentemente decorativos

Beschläge mit vorwiegend dekorativer funktion



BORCHIE DARK

Borchie Dark con funzione prevalentemente decorativa



26 321/20 cm +2x2
26 321/30 cm +3x3
26 321/40 cm +4x4
26 321/50 cm +5x5
perno 5 MA x 60



26 556/80 ø cm 8
26 556/105 ø cm 10,5
Il ø 8 predisposto anche per chiavistello 26 365



26 308/45 ø cm 4,5
perno 5 MA x 60

CROCI E CROCEFISSI ORO



croci
crocefissi

croix
crucifix

crosseses
crucifixes

cruces
cristos

kreuze
kruzifixe

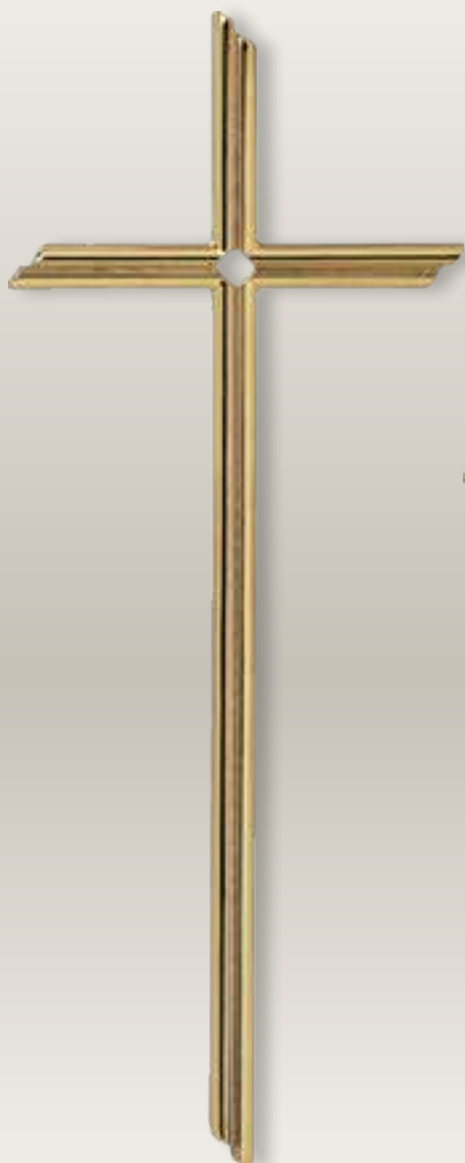

P 24 219/20 cm ±20x8,5

P 24 219/25 cm ±25x11

P 24 219/30 cm ±30x13

P 24 219/40 cm ±40x16



P 30 086/09 cm ±9x6,5

P 30 086/13 cm ±13x10

P 30 086/17 cm ±17x12

P 30 086/26 cm ±26x19

P 30 086/37 cm ±37x26



Madonna

P 32 587/106 cm ±11x8



Madonna

P 31 666/13 cm ±13x10

P 31 666/18 cm ±18x13



Cristo

P 31 677/13 cm ±13x9

P 31 677/18 cm ±18x12,5



Cristo

P 32 576/105 cm ±11x8,5



Pietà

P 31 103/18 cm ±18x13

P 31 103/26 cm ±26x19

GHIERE ORO



ghiere

embouts
reductions

ring nuts

lamparas

kranze



Diametro cm 4

T 9 868/10
cm $\pm 10, \pm \varnothing 6$ (con fiamma)

T 9 929/02
cm $\pm 2, \pm \varnothing 6$ (senza fiamma)



Diametro cm 5 ribassata

T 9 858/13
cm $\pm 13, \pm \varnothing 6$ (con fiamma)

T 9 917/0
cm $\pm 1,5, \pm \varnothing 6$ (senza fiamma)



Diametro cm 5

T 9 914/13
cm $\pm 13, \pm \varnothing 6,5$ (con fiamma)

T 9 827/03
cm $\pm 2,5, \pm \varnothing 6,5$ (senza fiamma)



T 9 936/12
cm $\pm 12, \pm \varnothing 8$ (con fiamma)

T 9 825/02
cm $\pm 1,5, \pm \varnothing 8$ (senza fiamma)



Diametro cm 6

T 9 806/17
cm $\pm 17, \pm \varnothing 8$ (con fiamma)

T 9 905/03
cm $\pm 3, \pm \varnothing 8$ (senza fiamma)

GHIERE PORTAFIAMMA
Riduttore da \varnothing cm 6 a cm 5

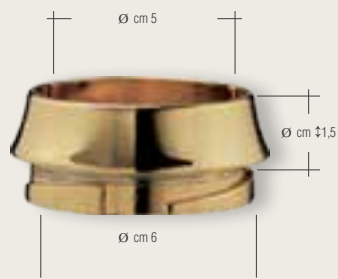

T 9 915/0
cm $\pm 1,5$



CORNICI ORO



- P 19 740/08** cm 8x10
- P 19 740/09** cm 9x12
- P 19 740/11** cm 11x15
- P 19 740/13** cm 13x18



- P 21 030/08** cm 8x10
- P 21 030/09** cm 9x12
- P 21 030/10** cm 10x15
- P 21 030/11** cm 11x15
- P 21 030/13** cm 13x18



- P 19 359/07** cm 7x9
- P 19 359/08** cm 8x10
- P 19 359/09** cm 9x12
- P 19 359/11** cm 11x15
- P 19 359/13** cm 13x18



- P 21 214/08** cm 8x10
- P 21 214/09** cm 9x12
- P 21 214/10** cm 10x15
- P 21 214/11** cm 11x15
- P 21 214/13** cm 13x18

Cabochons avec une fonction essentiellement decorative
 Studs prevalently for decorative use
 Clavos prevalentemente decorativos
 Beschläge mit vorwiegend dekorativer funktion



BORCHIE ORO

Borchie Oro con funzione prevalentemente decorativa



- 26 332/20** cm 2x2
- 26 332/30** cm 3x3
- 26 332/40** cm 4x4
- 26 332/50** cm 5x5
perno 5 MAx60



- 26 319/45** ø cm 4,5
perno 5 MAx60

Etriers pour les soutien des enfeux d'epaisseur variable
 Brackets for niches support with variable thickness
 Garras para sostener lapidas de espesor variable
 Grabstein-stützhalter mit verstellbarer dicthe



STAFFE ORO

Staffe con finitura in oro, per sostegno lapidi a spessore variabile

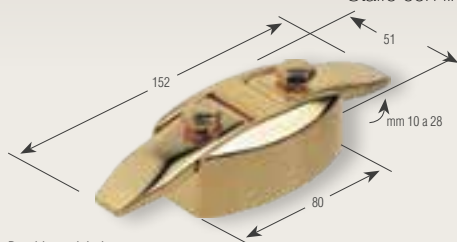

- 27 528/10**
≡ cm 1 a 2,8
perno 8 MA

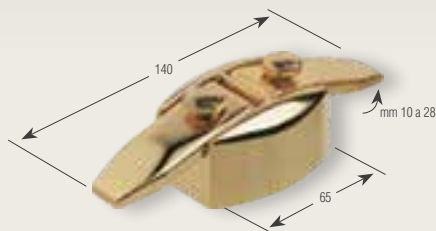

- 27 517/10**
≡ cm 1 a 2,8
perno 8 MA

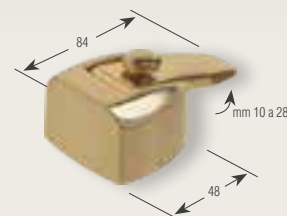

- 27 506/10**
≡ cm 1 a 2,8
perno 8 MA

Perni in acciaio inox compresi nel prezzo.
 Pivots en acier inox compris dans le prix.
 Stainless steel pivots included in price.
 Pernios en acero inox incluidos en precio.
 Bolzen aus rostfreiem Stahl im Preis einschliesslich.

A richiesta sarà fornita la documentazione tecnica relativa alla portata massima

Catena



- 28 071/100**
cm 7,5x3
Da ordinare al metro

PORCELLANA



portafiori
vasche
lampade

porte-fleurs
vases
lampes

vases
and lamps

bucaros
jardineras
lamparas

blumenvasen
schalen
lampen

OLMO PORCELLANA BIANCO DECORO ARGENTO

Designed by Alessandro Asti



P PO 177/21 
cm ±20,5x13,5,±12

T PO 178/21 
cm ±20,5x13,5,±06

P PO 739/20
cm ±19,5x10,5,±10

T PO 740/20
cm ±19,5x10,5,±04

P PO 179/18 
cm ±18x18,±12,5

T PO 180/18 
cm ±18x18,±12,5

CINERARI E OSSARI



P PO 739/15
cm ±15x8,±8



P PO 177/13 
cm ±13x8,5,±9

OLMO PORCELLANA

BIANCO DECORO ORO

Designed by Alessandro Asti

portafiori
vasche
lampade

porte-fleurs
vases
lampes

vases
and lamps

bucaros
jardineras
lamparas

blumenvasen
schalen
lampen



P PO 173/21 
cm ±20,5x13,5,±12

T PO 174/21 
cm ±20,5x13,5,±ø6



P PO 737/20
cm ±19,5x10,5,±10

T PO 738/20
cm ±19,5x10,5,±ø4



P PO 175/18 
cm ±18x18,±12,5

T PO 176/18 
cm ±20,5x13,5,±12,5



CINERARI E OSSARI



P PO 737/15
cm ±15x8,±8



P PO 173/13 
cm ±13x8,5,±9

portafiori
vasche
lampade

porte-fleurs
vases
lampes

vases
and lamps

bucaros
jardineras
lamparas

blumenvasen
schalen
lampen

OLMO PORCELLANA BIANCO

Designed by Alessandro Asti



P PO 133/21 
cm ±20,5x13,5,±12

I PO 134/21 
cm ±20,5x13,5,±ø6

P PO 717/20
cm ±19,5x10,5,±10

I PO 718/20
cm ±19,5x10,5,±ø4

P PO 135/18 
cm ±18x18,±12,5

I PO 136/18 
cm ±18x18,±12,5

CINERARI E OSSARI



P PO 717/15
cm ±15x8,±8



P PO 133/13 
cm ±13x8,5,±9

OLMO PORCELLANA BEIGE

Designed by Alessandro Asti

portafiori
vasche
lampade

porte-fleurs
vases
lampes

vases
and lamps

bucaros
jardineras
lamparas

blumenvasen
schalen
lampen



P PO 165/21 
cm ±20,5x13,5,±12

T PO 166/21 
cm ±20,5x13,5,±ø6



P PO 733/20
cm ±19,5x10,5,±10

T PO 734/20
cm ±19,5x10,5,±ø4



P PO 167/18 
cm ±18x18,±12,5

T PO 168/18 
cm ±18x18,±12,5

CINERARI E OSSARI



P PO 733/15
cm ±15x8,±8



P PO 165/13 
cm ±13x8,5,±9

portafiori
vasche
lampade

porte-fleurs
vases
lampes

vases
and lamps

bucaros
jardineras
lamparas

blumenvasen
schalen
lampen

OLMO PORCELLANA BEIGE DECORO ORO

Designed by Alessandro Asti



P PO 181/21 
cm ±20,5x13,5,±12

T PO 182/21 
cm ±20,5x13,5,±ø6

P PO 741/20
cm ±19,5x10,5,±10

T PO 742/20
cm ±19,5x10,5,±ø4

P PO 183/18 
cm ±18x18,±12,5

T PO 184/18 
cm ±18x18,±12,5

CINERARI E OSSARI



P PO 741/15
cm ±15x8,±8



P PO 181/13 
cm ±13x8,5,±9

IBISCO PORCELLANA

BIANCO FIORE COLORATO DECORATO A MANO

Designed by Gianluca Ugoletti

portafiori
vasche
lampade

porte-fleurs
vases
lampes

vases
and lamps

bucaros
jardineras
lamparas

blumenvasen
schalen
lampen



P PO 189/21 
cm ±20,5x12,→13

T PO 190/21 
cm ±20,5x12,→ø6

P PO 745/21
cm ±21,5x9,5,→10

T PO 746/21
cm ±21,5x9,5,→ø4,5

P PO 191/20 
cm ±19,5x17,5,→12,5

T PO 192/20 
cm ±19,5x17,5,→11x5,5

CINERARI E OSSARI



P PO 745/15
cm ±14,5x7,→9



P PO 189/13 
cm ±13x8,5,→9,5

portafiori
vasche
lampade

porte-fleurs
vases
lampes

vases
and lamps

bucaros
jardineras
lamparas

blumenvasen
schalen
lampen

IBISCO PORCELLANA BIANCO

Designed by Gianluca Ugoletti



P PO 137/21 
cm ±20,5x12,2x13

T PO 138/21 
cm ±20,5x12,2xø6

P PO 753/21
cm ±21,5x9,5x10

T PO 754/21
cm ±21,5x9,5xø4,5

P PO 139/20 
cm ±19,5x17,5x12,5

T PO 140/20 
cm ±19,5x17,5x11x5,5

CINERARI E OSSARI



P PO 753/15
cm ±14,5x7,2x9



P PO 137/13 
cm ±13x8,5x9,5

IBISCO PORCELLANA

BEIGE FIORE COLORATO DECORATO A MANO

Designed by Gianluca Ugoletti

portafiori
vasche
lampade

porte-fleurs
vases
lampes

vases
and lamps

bucaros
jardineras
lamparas

blumenvasen
schalen
lampen



P PO 193/21
cm ±20,5x12,↗13

I PO 194/21
cm ±20,5x12,↗±06



P PO 747/21
cm ±21,5x9,5,↗10

I PO 748/21
cm ±21,5x9,5,↗±04,5



P PO 195/20
cm ±19,5x17,5,↗12,5

I PO 196/20
cm ±19,5x17,5,↗±11x5,5

CINERARI E OSSARI



P PO 747/15
cm ±14,5x7,↗9



P PO 193/13
cm ±13x8,5,↗9,5

portafiori
vasche
lampade

porte-fleurs
vases
lampes

vases
and lamps

bucaros
jardineras
lamparas

blumenvasen
schalen
lampen

IBISCO PORCELLANA BEIGE

Designed by Gianluca Ugoletti



P PO 169/21 
cm ±20,5x12,±13

T PO 170/21 
cm ±20,5x12,±ø6

P PO 171/20 
cm ±19,5x17,5,±12,5

T PO 172/20 
cm ±19,5x17,5,±11x5,5

P PO 735/21
cm ±21,5x9,5,±10

T PO 736/21
cm ±21,5x9,5,±ø4,5



CINERARI E OSSARI



P PO 735/15
cm ±14,5x7,±9



P PO 169/13 
cm ±13x8,5,±9,5



IBISCO PORCELLANA CARRARA

Designed by Gianluca Ugoletti

portafiori
vasche
lampade

porte-fleurs
vases
lampes

vases
and lamps

bucaros
jardineras
lamparas

blumenvasen
schalen
lampen



P PO 197/21 
cm ±20,5x12,±13



T PO 198/21 
cm ±20,5x12,±ø6



P PO 199/20 
cm ±19,5x17,5,±12,5



T PO 200/20 
cm ±19,5x17,5,±11x5,5



P PO 749/21
cm ±21,5x9,5,±10



T PO 750/21
cm ±21,5x9,5,±ø4,5

portafiori
vasche
lampade

porte-fleurs
vases
lampes

vases
and lamps

bucaros
jardineras
lamparas

blumenvasen
schalen
lampen

IBISCO PORCELLANA BOTTICINO

Designed by Gianluca Ugoletti



P PO 201/21 
cm 20,5x12,5x13



T PO 202/21 
cm 20,5x12,5x16



P PO 203/20 
cm 19,5x17,5x12,5



T PO 204/20 
cm 19,5x17,5x11x5,5



P PO 751/21
cm 21,5x9,5x10



T PO 752/21
cm 21,5x9,5x10x4,5

LE CANTARE PORCELLANA BIANCO

Designed by Gianluca Ugoletti



portafiori
vasche
lampade

porte-fleurs
vases
lampes

vases
and lamps

bucaros
jardineras
lamparas

blumenvasen
schalen
lampen



P PO 205/20
cm ±21x12,5,±13

T PO 206/20
cm ±21x12,5,±ø8,5



P PO 755/19
cm ±20,5x10,±10,5

T PO 756/19
cm ±20,5x10,±ø5



P PO 207/19
cm ±19x17,5,±11,5

T PO 208/19
cm ±19x17,5,±11x5,5

CINERARI E OSSARI



P PO 755/15
cm ±14,5x8,±9



P PO 205/13
cm ±13x8,±9,5

portafiori
vasche
lampade

porte-fleurs
vases
lampes

vases
and lamps

bucaros
jardineras
lamparas

blumenvasen
schalen
lampen



LE CANTARE PORCELLANA BEIGE

Designed by Gianluca Ugoletti



P PO 209/20
cm ±21x12,5x13

T PO 210/20
cm ±21x12,5xø8,5

P PO 757/19
cm ±20,5x10x10,5

T PO 758/19
cm ±20,5x10xø5

P PO 211/19
cm ±19x17,5x11,5

T PO 212/19
cm ±19x17,5x11x5,5

CINERARI E OSSARI



P PO 757/15
cm ±14,5x8x9



P PO 209/13
cm ±13x8x9,5

ALBA PORCELLANA BIANCO

portafiori
vasche
lampade

porte-fleurs
vases
lampes

vases
and lamps

bucaros
jardineras
lamparas

blumenvasen
schalen
lampen



P PO 213/20 
cm ±20,5x11,5,±12,5

T PO 214/20 
cm ±20,5x11,5,±06



P PO 759/20
cm ±20,5x9,±10,5

T PO 760/20
cm ±20,5x9,±06



P PO 215/18 
cm ±18,5x19,±12,5

T PO 216/18 
cm ±18,5x19,±11x5,5

CINERARI E OSSARI



P PO 759/15
cm ±15x7,5,±9



P PO 213/13 
cm ±13,5x8,±09,5

portafiori
vasche
lampade

porte-fleurs
vases
lampes

vases
and lamps

bucaros
jardineras
lamparas

blumenvasen
schalen
lampen



ALBA PORCELLANA BEIGE



P PO 221/20
cm ±20,5x11,5,±12,5

T PO 222/20
cm ±20,5x11,5,±ø6

P PO 763/20
cm ±20,5x9,±10,5

T PO 764/20
cm ±20,5x9,±ø6

P PO 223/18
cm ±18,5x19,±12,5

T PO 224/18
cm ±18,5x19,±11x5,5

CINERARI E OSSARI



P PO 763/15
cm ±15x7,5,±9



P PO 221/13
cm ±13,5x8,±ø9,5

ALBA GRECA PORCELLANA BIANCO

portafiori
vasche
lampade

porte-fleurs
vases
lampes

vases
and lamps

bucaros
jardineras
lamparas

blumenvasen
schalen
lampen



P PO 217/20 
cm ±20,5x11,5x12,5

T PO 218/20 
cm ±20,5x11,5xø6



P PO 219/18 
cm ±18,5x19x12,5

T PO 220/18 
cm ±18,5x19x11x5,5



P PO 761/21 
cm ±20,5x9x10,5

T PO 762/21 
cm ±20,5x9xø6

ACCESSORI PORCELLANA



P P3 107/14
cm ±14x11



P P3 108/14
cm ±14x12



P P3 109/14
cm ±14x12



P P3 110/14
cm ±14x11



P P3 111/14
cm ±14x12



P P3 112/14
m ±14x12

P P3 107/17
cm ±17x13

P P3 108/17
cm ±17x15

P P3 109/18
cm ±18x15

P P3 110/17
cm ±17x13

P P3 111/17
cm ±17x15

P P3 112/18
cm ±18x15



P P2 313/13
cm ±13x6,5

P P2 313/17
cm ±17,5x8,5

P P2 313/22
cm ±22x10,5

P P2 313/26
cm ±26x12



P P1 909/09
cm ±9x12

P P1 909/11
cm ±11x15



P P2 109/09
cm ±9x12

P P2 109/11
cm ±11x15



P P2 314/13
cm ±13x6,5

P P2 314/17
cm ±17,5x8,5

P P2 314/22
cm ±22x10,5

P P2 314/26
cm ±26x12



P P1 910/09
cm ±9x12

P P1 910/11
cm ±11x15



P P2 110/09
cm ±9x12

P P2 110/11
cm ±11x15

P P2 201/05
cm ±5x9

P P2 201/07
cm ±8x12

P P2 201/09
cm ±10x16

P P2 201/12
cm ±12x19

P P2 201/15
cm ±15x23



Pergamene personalizzate

Caratteri disponibili:
Corsivo, Bastone o Romano
Nota: è importante, al momento dell'ordine,
specificare il tipo di carattere.
Il testo è compreso nel prezzo.



ACCIAIO INOX



EVOLUTION

INOX LUCIDA

portafiori
vasche
lampade

porte-fleurs
vases
lampes

vases
and lamps

bucaras
jardineras
lamparas

blumenvasen
schalen
lampen



P 60 720/20R ①
cm ±20x11, ±11,5

T 60 740/20R ①
cm ±20x11, ±07



P 66 070/19
cm ±18x8, ±8,5

T 66 080/19
cm ±18x8, ±06



P 60 820/18R ①
cm ±18x17, ±11

T 60 840/18R ①
cm ±18x17, ±13x8



P 77 039/12
cm ±12x6

P 77 039/15
cm ±15x7

P 77 039/20
cm ±20x9,5

P 77 039/30
cm ±30x11,5

P 77 039/40
cm ±40x15,5



P 71 121/09
cm 9x12

P 71 121/11
cm 11x15



P 72 212/09
cm 9x12

P 72 212/10
cm 10x15

P 72 212/11
cm 11x15

portafiori
vasche
lampade

porte-fleurs
vases
lampes

vases
and lamps

bucaros
jardineras
lamparas

blumenvasen
schalen
lampen

EVOLUTION

INOX SATINATA



P 60 705/20R ⓘ
cm ±20x11, ±11,5

I 60 735/20R ⓘ
cm ±20x11, ±ø7



P 66 072/19
cm ±18x8, ±8,5

I 66 088/19
cm ±18x8, ±ø6



P 60 808/18R ⓘ
cm ±18x17, ±11

I 60 823/18R ⓘ
cm ±18x17, ±13x8



P 77 119/12
cm ±12x6

P 77 119/15
cm ±15x7

P 77 119/20
cm ±20x9,5

P 77 119/30
cm ±30x11,5

P 77 119/40
cm ±40x15,5



P 71 182/09
cm 9x12

P 71 182/11
cm 11x15



P 72 324/09
cm 9x12

P 72 324/10
cm 10x15

P 72 324/11
cm 11x15

EVOLUTION

INOX BLU

Direzione creativa: Fabio Ragni

portafiori
vasche
lampade

porte-fleurs
vases
lampes

vases
and lamps

bucaros
jardineras
lamparas

blumenvasen
schalen
lampen



P 60 150/20R ◉
cm ±20x11,±11,5

T 60 173/20R ◉
cm ±20x11,±10,7



P 66 010/19
cm ±18x8,±8,5

T 66 030/19
cm ±18x8,±10,6



P 60 180/18R ◉
cm ±18x17,±11

T 60 193/18R ◉
cm ±18x17,±13x8



P 77 030/15
cm ±14,5x7

P 77 030/20
cm ±19,5x9,5



P 71 121/09
cm 9x12

P 71 121/11
cm 11x15



P 72 212/09
cm 9x12

P 72 212/10
cm 10x15

P 72 212/11
cm 11x15

portafiori
vasche
lampade

porte-fleurs
vases
lampes

vases
and lamps

bucaros
jardineras
lamparas

blumenvasen
schalen
lampen

EVOLUTION INOX BIANCO

Direzione creativa: Fabio Ragni



P 60 159/20R ◉
cm ±20x11,±11,5

T 60 178/20R ◉
cm ±20x11,±ø 7



P 66 018/19
cm ±18x8,±8,5

T 66 037/19
cm ±18x8,±ø 6



P 60 184/18R ◉
cm ±18x17,±11

T 60 198/18R ◉
cm ±18x17,±13x8



P 77 040/15
cm ±14,5x7

P 77 040/20
cm ±19,5x9,5



P 71 121/09
cm 9x12

P 71 121/11
cm 11x15



P 72 212/09
cm 9x12

P 72 212/10
cm 10x15

P 72 212/11
cm 11x15

NILO INOX

Designed by Alberto Nodolini

portafiori
vasche
lampade

porte-fleurs
vases
lampes

vases
and lamps

bucaros
jardineras
lamparas

blumenvasen
schalen
lampen



P 63 140/20 ◉
cm ±20x13,5,±13



P 67 500/19
cm ±18,5x11,±10,5



P 63 142/17 ◉
cm ±17x19,±13



P 71 519/09 cm 9x12
P 71 519/11 cm 11x15



P 72 511/09 cm 9x12
P 72 511/10 cm 10x15

portafiori
vasche
lampade

porte-fleurs
vases
lampes

vases
and lamps

bucaros
jardineras
lamparas

blumenvasen
schalen
lampen

CLAUDIA INOX

Designed by Vittorio Asti



P 63 111/19 
cm ±19x11,↗10,5

I 63 122/19 
cm ±19x11,↗6,5x6,5



P 67 514/17
cm ±17x10,↗9

I 67 525/17
cm ±17x10,↗7,5x6



P 63 133/16 
cm ±16x18,↗11,5,↗15x10
Predisposta anche per
l'applicazione a terreno



P 77 516/20
cm ±20x9

P 77 516/28
cm ±28x14



P 71 519/09
cm 9x12

P 71 519/11
cm 11x15



P 72 511/09
cm 9x12

P 72 511/10
cm 10x15



P 67 536/19
cm ±19x15,↗8,5



P 63 155/15 
cm ±15x31,↗11,↗28x9

Predisposta anche per
l'applicazione a terreno



portafiori
vasche
lampade

porte-fleurs
vases
lampes

vases
and lamps

bucaros
jardineras
lamparas

blumenvasen
schalen
lampen

ATHENEAE INOX

Designed by Gianluca Ugoletti



P 66 101/20
cm ±20x10,±10,5

T 66 110/20
cm ±20x10,±ø6



P 60 001/20 ◐
cm ±20x9,5,±10

T 60 010/20 ◐
cm ±20x9,5,±ø6

CINERARI E OSSARI



P 66 101/15
cm ±14,5x6,5,±7



P 60 001/13 ◐
cm ±13x7,±7,5



T 66 120/12
cm ±12,±ø8



T 61 021/04 ◐
cm ±2,5,±ø10



T 61 023/10 ◐
cm ±9,5,±ø5

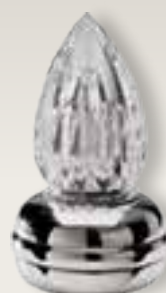

T 66 116/15
cm ±15x6,5,±ø6



T 60 010/29 ◐
cm ±29x14,±ø8,5

ATHENEAE

INOX BORDO ORO

Designed by Gianluca Ugoletti



portafiori
vasche
lampade

porte-fleurs
vases
lampes

vases
and lamps

bucaros
jardineras
lamparas

blumenvasen
schalen
lampen



P 66 103/20
cm :20x10,5x10,5

T 66 112/20
cm :20x10,5xø6



P 60 003/20

cm :20x9,5x10

T 60 012/20

cm :20x9,5xø6

CINERARI E OSSARI



P 66 103/15
cm :14,5x6,5x7



P 60 003/13

cm :13x7,5x7,5



T 66 118/15
cm :15x6,5xø6



T 61 025/10

cm :9,5xø5



T 60 012/29

cm :29x14,5xø8,5

portafiori
vasche
lampade

porte-fleurs
vases
lampes

vases
and lamps

bucaros
jardineras
lamparas

blumenvasen
schalen
lampen

TULIPANO

INOX



P 66 250/20
cm ±20x14,5,-7,5



P 60 510/20 
cm ±19x18,5,-9



P 60 810/20 
cm ±19x18,5,-9

portafiori
vasche
lampade

porte-fleurs
vases
lampes

vases
and lamps

bucaros
jardineras
lamparas

blumenvasen
schalen
lampen



P 66 876/12
cm ±12x11,5,±9

I 66 887/12
cm ±12x11,5,±9,5x4



P 60 675/19 Ⓟ
cm ±19x12,±10

I 60 686/19 Ⓟ
cm ±19x12,±9,5x4



P 66 752/16
cm ±16x10,5,±9

I 66 763/16
cm ±16x10,5,±8,5x4



P 61 016/19 Ⓟ
cm ±19x11,±10

I 61 027/19 Ⓟ
cm ±19x11,±8,5x4,5



P 66 273/17
cm ±17x9,5,±9

I 66 284/17
cm ±18x9,5,±6x6



P 60 312/20 Ⓟ
cm ±20x9,5,±9,5

I 60 323/20 Ⓟ
cm ±21x9,5,±6x6



P 68 116/17
cm ±17x10,±12

I 68 127/20
cm ±20x10,±7,5x5,5

portafiori
vasche
lampade

porte-fleurs
vases
lampes

vases
and lamps

bucaros
jardineras
lamparas

blumenvasen
schalen
lampen



P 66 672/16
cm ±16x10,5±9

I 66 683/16
cm ±16x10,5±8,5x4



P 60 915/19

cm ±19x10,5±10,5

I 60 926/19

cm ±19x10,5±8,5x4



P 66 694/16
cm ±16x10,5±9

I 66 706/16
cm ±16x10,5±8,5x4



P 60 937/19

cm ±19x10,5±10,5

I 60 948/19

cm ±19x10,5±8,5x4



P 66 854/16
cm ±16x10,5±9

I 66 865/16
cm ±16x10,5±8,5x4



P 61 197/19

cm ±19x11±11

I 61 209/19

cm ±19x11±8,5x4



P 66 832/16
cm ±16x10,5±9

I 66 843/16
cm ±16x10,5±8,5x4



P 61 175/19

cm ±19x11±11

I 61 186/19

cm ±19x11±8,5x4



P 66 774/12
cm ±12x10,5±9

I 66 785/14
cm ±13,5x10,5±8,5x4



P 60 959/19

cm ±19x10,5±10,5

I 60 961/21

cm ±21x10,5±8,5x4



P 66 739/12
cm ±12x10,5±9

I 66 741/14
cm ±13,5x10,5±8,5x4



P 60 972/19

cm ±19x10,5±10,5

I 60 983/21

cm ±21x10,5±8,5x4

portafiori
vasche
lampade

porte-fleurs
vases
lampes

vases
and lamps

bucaros
jardineras
lamparas

blumenvasen
schalen
lampen



P 66 477/12
cm :11,5x10,5,↔8

T 66 488/14
cm :13,5x10,5,↔8,5x4



P 60 733/20 ⓘ
cm :19x10,5,↔9,5

T 60 744/21 ⓘ
cm :21x10,5,↔8,5x4



P 60 755/20 ⓘ
cm :19x10,5,↔9,5

T 60 766/21 ⓘ
cm :21x10,5,↔8,5x4



P 60 777/20 ⓘ
cm :19x10,5,↔9,5

T 60 788/21 ⓘ
cm :21x10,5,↔8,5x4



P 66 912/17
cm :17x9,5,↔9

T 66 923/17
cm :18x9,5,↔6x6



P 61 233/20 ⓘ
cm :20x9,5,↔9,5

T 61 244/21 ⓘ
cm :21x9,5,↔6x6



P 66 535/10
cm :10,5x11,5,↔8,5

T 66 546/12
cm :12x11,5,↔11,5x6



P 60 857/19 ⓘ
cm :20x12,↔8,5

T 60 868/21 ⓘ
cm :21,5x12,↔11,5x6

portafiori
vasche
lampade

porte-fleurs
vases
lampes

vases
and lamps

bucaros
jardineras
lamparas

blumenvasen
schalen
lampen



P 66 513/10
cm ±10,5x11,5x8,5

T 66 524/12
cm ±12x11,5x11,5x6



P 60 835/19 ⓘ
cm ±20x12x8,5

T 60 846/21 ⓘ
cm ±21,5x12x11,5x6



P 68 116/17
cm ±17x10x12

T 68 127/20
cm ±20x10x7,5x5,5



T 68 010/22
cm ±22x12x12x12
Satinata



P 66 433/18
cm ±18,5x9x11,5



P 60 697/19 ⓘ
cm ±19x12x11,5



P 66 455/18
cm ±18,5x8,5x11,5



P 60 711/19 ⓘ
cm ±19x11x12,5

portafiori
vasche
lampade

porte-fleurs
vases
lampes

vases
and lamps

bucaros
jardineras
lamparas

blumenvasen
schalen
lampen



P 66 318/18
cm :18x11,5-9

T 66 329/20
cm :20x11,5-ø8



P 60 356/19 
cm :19,5x11,5-9

T 60 367/21 
cm :21x11,5-ø8



P 66 295/18
cm :18x11,5-9

T 66 307/20
cm :20x11,5-ø8



P 60 334/19 
cm :19,5x11,5-9

T 60 345/21 
cm :21x11,5-ø8



T 66 364/32
cm :32x17-ø12



T 60 403/31 
cm :31,5x17-ø12



T 66 342/32
cm :32x17-ø12



T 60 389/31 
cm :31,5x17-ø12

portafiori
vasche
lampade

porte-fleurs
vases
lampes

vases
and lamps

bucaros
jardineras
lamparas

blumenvasen
schalen
lampen



P 66 193/16
cm :16x9,5x11

T 66 205/17
cm :17x9,5x07



P 66 114/16
cm :16x9,5x11

T 66 125/19
cm :18x9,5x07



P 66 136/18
cm :18x10,5x12

T 66 147/21
cm :21x10,5x07



P 68 014/17
cm :17x11x14

T 68 025/20
cm :20x11x08,5



P 68 036/23
cm :23x11x13

T 68 047/26
cm :26x11x08,5



P 60 174/19 
cm :19x9,5x10

T 60 185/21 
cm :20x9,5x07



P 60 152/18 
cm :18x8x8,5

T 60 163/19 
cm :19x8x04,5



P 60 196/18 
cm :18x11,5x11,5

T 60 208/22 
cm :22x11,5x08



P 60 117/19 
cm :19x9,5x10

T 60 128/20 
cm :20x9,5x07



P 60 139/19 
cm :19x11x11

T 60 141/22 
cm :22x11x08

CINERARI E OSSARI INOX

cinerari
e ossari

vases et
lampes pour
colombarium

accessories
for ossuaries

osarios

zūbehör für
ossarium

PORTAORCHIDEA
CROMINOX



P 60 007/10
cm ±11x3,5±4



P 60 009/10
cm ±11x3,5±4

con anello dorato

PORTAORCHIDEA
ACCIAIO INOX FUSO



P 60 120/12 Ⓢ
cm ±14x4,5±5

acciaio inox fuso



P 66 171/12
cm ±12x8±11

T 66 182/12
cm ±12x8±ø6,5



P 60 152/13 Ⓢ
cm ±13x7,7±7,5

T 60 163/14 Ⓢ
cm ±14x7±ø4,5



P 66 034/12
cm ±12x7,5±6,5

T 66 045/14
cm ±14x7,5±ø5,5



P 60 037/13 Ⓢ
cm ±13x7,5±6,5

T 60 048/14 Ⓢ
cm ±14x7,5±ø5,5



P 66 012/12
cm ±12x7,5±6,5

T 66 023/14
cm ±14x7,5±ø5,5



P 60 015/13 Ⓢ
cm ±13x7,5±6,5

T 60 026/14 Ⓢ
cm ±14x7,5±ø5,5



P 66 101/15
cm ±14,5x6,5±7



P 60 001/13 Ⓢ
cm ±13x7,7±7,5



P 66 103/15
cm ±14,5x6,5±7



P 60 003/13 Ⓢ
cm ±13x7,7±7,5

PORTAFOTO VERTICALE

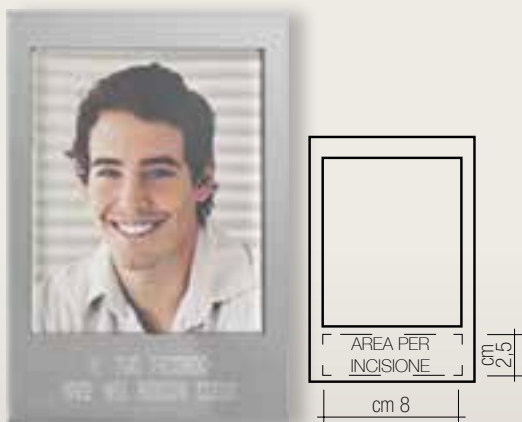

P 72 640/14

Portafoto verticale cm \pm 14x9,5
Fotoceramiche rettangolari cm 8x10
Acciaio lucido
senza luce

PORTAFOTO VERTICALE CON LUCE INTEGRATA



P 72 620/17

Portafoto verticale cm \pm 17x9,5
Fotoceramiche rettangolari cm 8x10
Acciaio lucido
con luce

PORTAFOTO ORIZZONTALE CON LUCE INTEGRATA



P 72 600/12

Portafoto orizzontale cm \pm 12x23
Fotoceramiche rettangolari cm 8x10
Acciaio lucido
con luce

La collezione di portafoto rappresenta una soluzione esteticamente innovativa, tecnicamente evoluta ed integrata per la rappresentazione di fotografia, dedica e illuminazione votiva nella decorazione funeraria per lapidi.

L'illuminazione è a led.

Le finiture dell'acciaio sono ottenute per elettrocolorazione per la migliore garanzia di durata nel tempo.

Incisione compresa nel prezzo

CORNICI INOX FUSE

cornici cadres frames portarretratos bilderrahmen



- P 71 823/09** cm 9x12
- P 71 823/11** cm 11x15
- P 71 823/13** cm 13x18
- P 71 823/18** cm 18x24
Acciaio Inox Fuso



- P 71 519/09** cm 9x12
- P 71 519/11** cm 11x15
Acciaio Inox Fuso



- P 72 511/09** cm 9x12
- P 72 511/10** cm 10x15
Acciaio Inox Fuso



- P 71 121/09** cm 9x12
- P 71 121/11** cm 11x15
Acciaio Inox Fuso



- P 72 212/09** cm 9x12
- P 72 212/10** cm 10x15
- P 72 212/11** cm 11x15
Acciaio Inox Fuso



- P 71 182/09** cm 9x12
- P 71 182/11** cm 11x15
Acciaio Inox Fuso
Satinato



- P 72 324/09** cm 9x12
- P 72 324/10** cm 10x15
- P 72 324/11** cm 11x15
Acciaio Inox Fuso
Satinato

CORNICI INOX



- P 71 097/07** cm 7x9
- P 71 097/08** cm 8x10
- P 71 097/09** cm 9x12
- P 71 097/11** cm 11x15
- P 71 097/13** cm 13x18



- P 71 075/08** cm 8x10
- P 71 075/09** cm 9x12
- P 71 075/11** cm 11x15



- P 71 020/08** cm 8x10
- P 71 020/09** cm 9x12
- P 71 020/11** cm 11x15



- P 71 111/06** cm 6x8
- P 71 111/07** cm 7x9
- P 71 111/08** cm 8x10
- P 71 111/09** cm 9x12
- P 71 111/11** cm 11x15



- P 72 098/08** cm 8x10
- P 72 098/09** cm 9x12
- P 72 098/10** cm 10x15
- P 72 098/11** cm 11x15
- P 72 098/13** cm 13x18



- P 71 018/09**
cm 9x12



- P 71 031/09**
cm 9x12



- P 71 053/09**
cm 9x12



- P 72 054/09**
cm 9x12



- P 77 039/12**
cm ±12x6
- P 77 039/15**
cm ±15x7
- P 77 039/20**
cm ±20x9,5
- P 77 039/30**
cm ±30x11,5
- P 77 039/40**
cm ±40x15,5



- P 77 119/12**
cm ±12x6
- P 77 119/15**
cm ±15x7
- P 77 119/20**
cm ±20x9,5
- P 77 119/30**
cm ±30x11,5
- P 77 119/40**
cm ±40x15,5
Satinato



- P 77 040/15**
cm ±14,5x7
- P 77 040/20**
cm ±19,5x9,5
Acciaio Inox Fuso



- P 77 030/15**
cm ±14,5x7
- P 77 030/20**
cm ±19,5x9,5
Acciaio Inox Fuso



- P 77 031/15**
cm ±15x7
- P 77 031/20**
cm ±20x9,5
- P 77 031/25**
cm ±25x11,5
- P 77 031/30**
cm ±30x14
Croci in acciaio traforato
spessore mm 3



- P 77 038/20**
cm ±20x14,5



- P 77 036/20**
cm ±20x14,5



- P 77 516/20**
cm ±20x9



- P 77 015/15**
cm ±15x9



- P 77 037/15**
cm ±15x9



- P 77 059/11**
cm ±11x5

- P 77 516/28**
cm ±28x14

- P 77 015/20**
cm ±20x12

- P 77 037/20**
cm ±20x12

- P 77 059/20**
cm ±20x9

Acciaio Inox Fuso

- P 77 059/27**
cm ±27x12



Sezione cm 2,5x1

- P 77 139/20**
cm ±20x9,5
- P 77 139/25**
cm ±25x10
- P 77 139/30**
cm ±30x12



Sezione cm 2,5x1

- P 77 117/20**
cm ±20x9,5
- P 77 117/25**
cm ±25x10
- P 77 117/30**
cm ±30x12



Sezione cm 1x1,5

- P 77 094/08**
cm ±8,5x4
- P 77 094/10**
cm ±10x4
- P 77 094/12**
cm ±12x4,5

- P 77 094/15**
cm ±15x5
- P 77 094/20**
cm ±20x5,5
- P 77 094/25**
cm ±25x7
- P 77 094/30**
cm ±30x7,5



Sezione cm 1x1,5

- P 77 072/15**
cm ±15x7
- P 77 072/20**
cm ±20x8
- P 77 072/25**
cm ±25x9
- P 77 072/30**
cm ±30x9

STAFFE INOX

Etriers pour les soutiens des enfeux d'épaisseur variable Brackets for niches support with variable thickness Garras para sostener lapidas de espesor variable Grabstein-stützhalter mit verstellbarer dicke

Staffe in acciaio fuso, per sostegno lapidi a spessore variabile

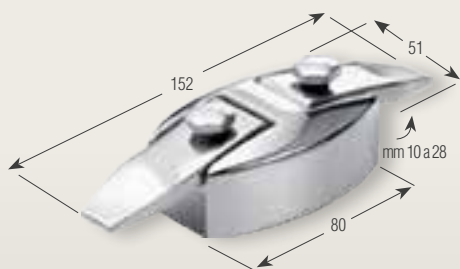

78 322/10
≙ cm 1 a 2,8
perno 8 MA

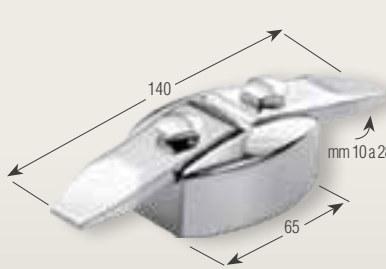

78 311/10
≙ cm 1 a 2,8
perno 8 MA

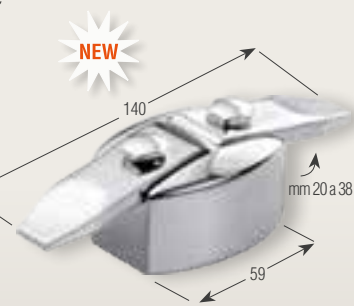

78 002/20
≙ cm 2 a 3,8
perno 8 MA

Perni in acciaio inox compresi nel prezzo.
Pivots en acier inox compris dans le prix.
Stainless steel pivots included in price.
Pernios en acero inox incluidos en precio.
Bolzen aus rostfreiem Stahl im Preis einschliesslich.

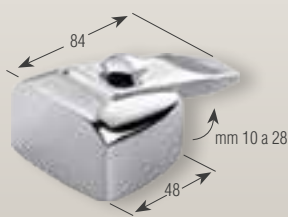

78 309/10
≙ cm 1 a 2,8
perno 8 MA



78 001/20
≙ cm 2 a 3,8
perno 8 MA

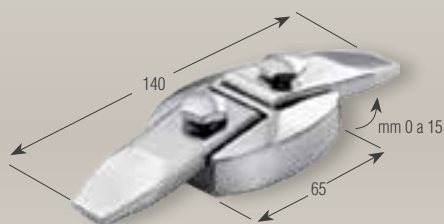

78 311/00
≙ cm 0 a 1,5
perno 6 MA

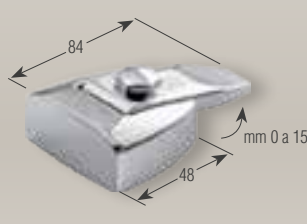

78 309/00
≙ cm 0 a 1,5
perno 6 MA

A RICHIESTA sarà fornita la documentazione tecnica relativa alla portata massima

ACCESSORI INOX

Borchia tipo Parma in Acciaio fuso

Rondella regolabile per diversi spessori di marmo

Rondelle réglable en fonction des différentes épaisseurs de marbre

Adjustable washer for different thickness of marble

Arandela regulable para diversos espesores

Regulierbare unterlegscheiben für verschiedene Marmor-Dichten



Tipo Parma
79 161/30 ø cm 3
79 161/40 ø cm 4
79 161/55 ø cm 5,5
con perno 8 MA
in acciaio inox



79 079/830 ø cm 3
79 079/840 ø cm 4
79 079/855 ø cm 5,5
perno 8 MAx90

ACCESSORI INOX

Borchie in acciaio inox 18/8 per sostegno lapidi

Cabocheons pour le soutien des enfeux

Supporting studs for niches

Clavos para sostener lapidas

Beschläge als Grabsteinstützen



79 017/03
ø cm 3

79 017/04
ø cm 4

79 017/05
ø cm 5
borchia innesto



79 028/03
ø cm 3



79 063/03
ø cm 3

79 063/04
ø cm 4

79 063/05
ø cm 5



79 052/03
cm ±3x3

79 052/04
cm ±4x4

79 052/05
cm ±5x5



79 074/45
cm ±4,5x4,5

Perni compresi nel prezzo.
Pivots compris dans le prix.
Pivots are included in price.
Pernios incluidos en precio.
Bolzen im Preis einschliesslich.

Ghiere in Acciaio Inox Fuso

embouts reductions

ring nuts

lamparas

kranze



79 369/12
cm ±12x7

79 369/13
cm ±13x9



79 350/04
cm ±10,±06
con fiamma
Diametro cm. 4
Acciaio Inox Fuso



79 350/05
cm ±14,±06,5
con fiamma
Diametro cm. 5
Acciaio Inox Fuso



79 350/06
cm ±17,±08
con fiamma
Diametro cm. 6
Acciaio Inox Fuso

Lampada pensile Acciaio Inox fuso

lampes suspendues

hanging lamps

lamparas colgantes

hängelampen



80 050/100 cm 100 ø cm 40

CAGGIATI

DESIGN

Designed by Habits Studio





FRAMMENTI

FRAGMENTS



Il progetto è una metafora plastica. Una forma completa si spezza e rimane tuttavia bloccata in una stasi atemporale. La composizione che ne risulta è di un dinamismo profondo. Gli oggetti spaccati rivelano un'anima preziosa ed inaspettata che ne impreziosisce, per contrasto, lo scuro aspetto esterno.

The project is a plastic metaphor. A complete form is broken up yet remains locked inside a timeless interlude. The resulting composition is of a profound dynamism. The broken objects reveal a precious and unexpected soul, which enhances, by contrast, the dark outer appearance.



Lampada elettrica

P 7 067/11
cm ±11x12,5x9
Inclusa lampada a led



Vaso

P 4 040/21 
cm ±21x14x11



RITORNO ALLA NATURA

BACK TO NATURE

La vegetazione, con la sua crescita continua e silenziosa, accompagna il fluire del tempo. Il decoro suggerisce questa condizione naturale in cui si trovano storicamente i monumenti commemorativi. In questo progetto la natura si riappropria in modo estetico e controllato dell'artefatto umano.

Vegetation, with its constant and silent growth, accompanies the flow of time. The ornament suggests this natural condition in which commemorative monuments are historically situated. In this project nature regains possession, in an aesthetic and controlled manner, of the human artefact.



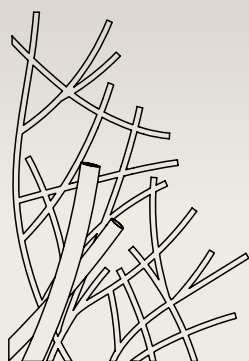

Monoblocco Brown SX

P 60 070/54 
cm ±54x37,±4,5



Lampada elettrica
Brown SX

P 66 075/15
cm ±15x12,±4,5
Inclusa lampada a led



Vaso Brown

P 60 168/20R 
cm ±20x11,±11,5



Lampada elettrica
Brown DX

P 66 084/15
cm ±15x12,±4,5
Inclusa lampada a led

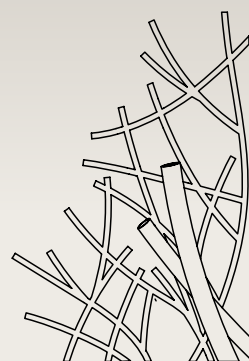

Monoblocco Brown DX

P 60 083/54 
cm ±54x37,±4,5

CON L'ACQUISTO DEL KIT COMPLETO (MONOBLOCCO E LAMPADA) IL VASO È IN OMAGGIO
RITORNO ALLA NATURA SX BROWN

P 15 010

CON L'ACQUISTO DEL KIT COMPLETO (MONOBLOCCO E LAMPADA) IL VASO È IN OMAGGIO
RITORNO ALLA NATURA DX BROWN

P 15 000

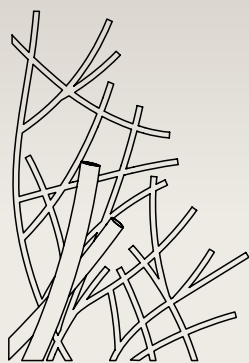

Monoblocco Blu SX

P 60 040/54 
cm ±54x37,±4,5

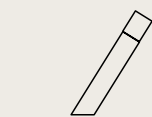

Lampada elettrica
Inox SX

P 66 033/15
cm ±15x12,±4,5
Inclusa lampada a led



Vaso Inox

P 60 720/20R 
cm ±20x11,±11,5



Lampada elettrica
Inox DX

P 66 044/15
cm ±15x12,±4,5
Inclusa lampada a led

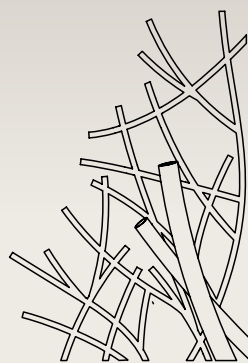

Monoblocco Blu DX

P 60 055/54 
cm ±54x37,±4,5

CON L'ACQUISTO DEL KIT COMPLETO
(MONOBLOCCO E LAMPADA) IL VASO È IN OMAGGIO
RITORNO ALLA NATURA SX BLU

P 15 025

CON L'ACQUISTO DEL KIT COMPLETO
(MONOBLOCCO E LAMPADA) IL VASO È IN OMAGGIO
RITORNO ALLA NATURA DX BLU

P 15 020



ANIMA

SOUL

Leggerezza e sospensione sono il tema del progetto Anima. Il corpo vitreo e trasparente di forma parallelepipedica, astratta e secca, racchiude un oggetto sinuoso, bianco, che evoca il segno di ampole provenienti dalla tradizione. L'atmosfera che ne scaturisce è eterea ed impalpabile.

Lightness and suspension are the themes of the project Anima. The transparent glass body with its sober, linear form encloses a supple white object, which recalls the shape of traditional urns. The atmosphere that is released is ethereal and impalpable.

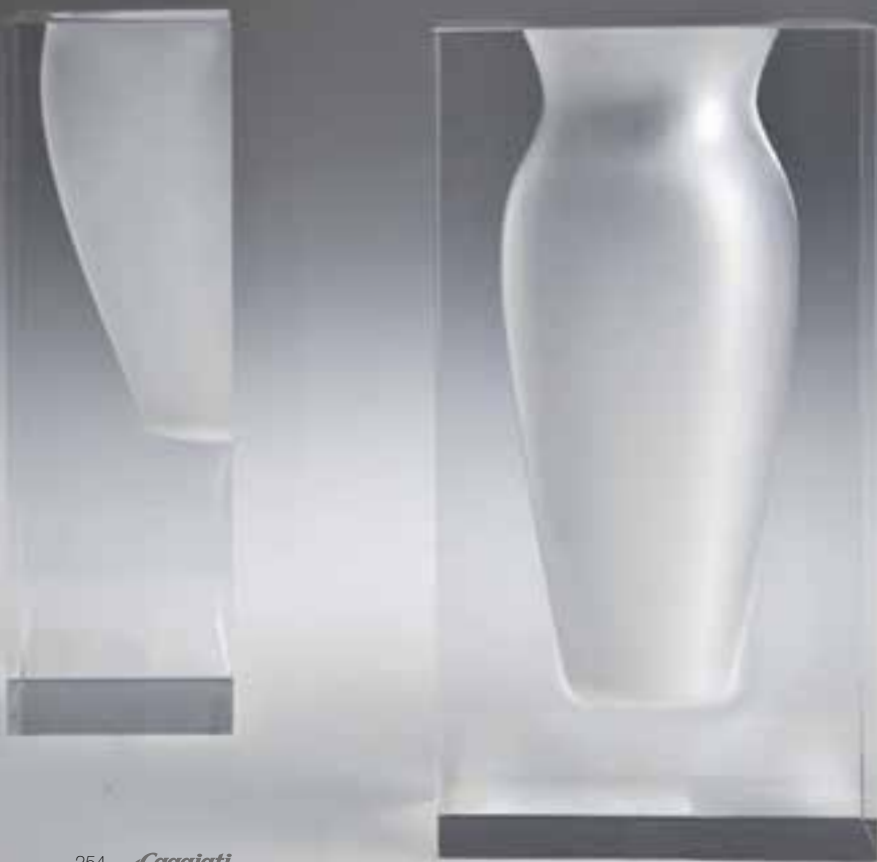



Lampada elettrica

P 66 015/24
cm 24x10,4x4,5
Inclusa lampada a led



Vaso

P 60 050/19 
cm 19x10,4x6,5



TEMPO

TIME

Il tempo agisce sui manufatti dell'uomo e sulle loro superfici provocando profonde alterazioni e rendendole discontinue. In questo progetto i segni lasciati dal tempo divengono a loro volta segni grafici di discontinuità e ritmo dell'elemento orizzontale.

Time (tempo) works on man's objects and their surfaces, altering them profoundly and making them inconstant. In this project the marks left by time in turn become graphic signs of discontinuity and the rhythm of the horizontal element.



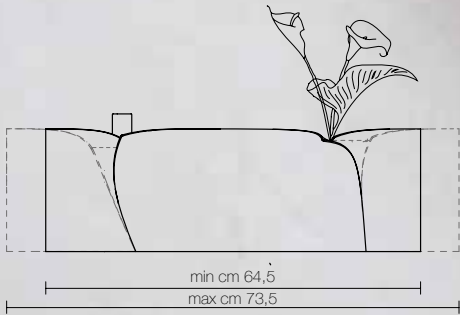
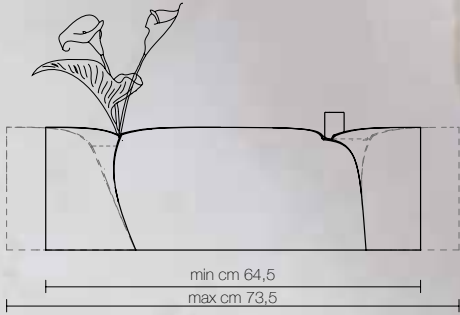

Monoblocco

P 15 040

cm ±21x(65,4 - 73,5),±9
Inclusa lampada a led
Incisione inclusa nel prezzo





CONTINUITÀ

CONTINUITY



Il volatile, delicatamente, si disseta alla fonte vitale dando continuità al ciclo naturale dell'esistenza.

Si posa lievemente sull'oggetto che contiene anche i fiori, metafora della flora, e insieme ad essi si abbevera dalla stessa fonte d'acqua.

The bird delicately quenches its thirst at the vital source, giving continuity to the natural cycle of existence. It rests lightly on the object, which also holds flowers, a metaphor for flora, and together they both drink from the same source of water.



Lampada elettrica

P 66 020/11
cm :11x20,2x11
Inclusa lampada a led



Vaso

P 60 011/23 
cm :23x35,2x13



SOFFIO

BREATH



Il soffio è metafora del fluire dell'esistenza, effimera, ma di estrema bellezza plastica. La forma esprime una sequenzialità senza soluzione di continuità tra passato e presente, fronte e rovescio, finissimo tessuto e metallo denso.

The breath (soffio) is a metaphor for the flowing of life, ephemeral but of great plastic beauty. The form expresses an endless sequentiality between past and present, front and back, extremely fine fabric and dense metal.



Monoblocco

P 15 030 

cm :35x(65 - 75),~6
Inclusa lampada a led

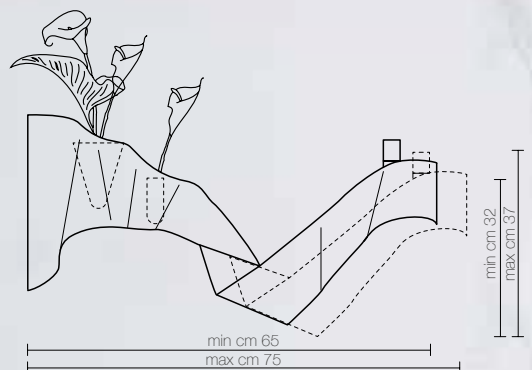

TERMANI
CRISTIANO
747 2011

CARATTERI



LYDIAN



caratteri lettres lettering letras schriftzeichen

A B C D

E F G H I

J K L M

N O P Q R

S T U V

W X Y Z

1 2 3 4 5 6 7 8 9 0

* † • , ’ —



LYDIAN

BRONZO

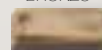

CENTIMETRI

LETTERE

B

2,5
4
5

NUMERI

5

2,5

STELLA E CROCE

* †

2,5

PUNTEGGIATURA

BRONZO



PUNTO

•

piccolo
medio

VIRGOLA

,

piccola
media

ACCENTO

’

piccolo
medio

TRATTINO

—

piccolo
medio



A B C D

E F G H I

J K L M

N O P Q R

S T U V

W X Y Z

1 2 3 4 5 6 7 8 9 0

* † • ‡ —



LYDIAN

UNI BLANC

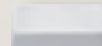

CENTIMETRI

LETTERE	B	2,5 4 5
NUMERI	5	2,5
STELLA E CROCE	* †	2,5

PUNTEGGIATURA

UNI BLANC



PUNTO	•	piccolo medio
VIRGOLA	‡	piccola media
ACCENTO	ˆ	piccolo medio
TRATTINO	—	piccolo medio



A B C D

E F G H I

J K L M

N O P Q

R S T U V

W X Y Z

1 2 3 4 5 6 7 8 9 0

* † Æ Ø Ł

• , ° ^ _ ∨ †





MUNDIAL

MUNDIAL

		BRONZO	ORO	DARK	UNIBLANC	CLASSIC	BOTTICINO	CARRARA	DECORATI*
		CENTIMETRI	CENTIMETRI	CENTIMETRI	CENTIMETRI	CENTIMETRI	CENTIMETRI	CENTIMETRI	CENTIMETRI
LETTERE	B	2,5	2,5	2,5	2,5	2,5	2,5	2,5	2,5
		3	3	3	3	3	3	3	3
		4	4	4	4	4	4	4	4
		5	5	5	5	5	5	5	5
		6	6	6	6	6	6	6	6
		8							
	10								
NUMERI	5	2,5	2,5	2,5	2,5	2,5	2,5	2,5	2,5
		3	3	3	3	3	3	3	3
STELLA E CROCE	*+	4	4	4	4	4	4	4	4
		5	5	5	5	5	5	5	5
CARATTERI SPECIALI	Æ Ø	2,5							
		3							
	L	2,5							
		3							
	4								
	5								
	6								

PUNTEGGIATURA

		BRONZO	ORO	DARK	UNIBLANC	CLASSIC	BOTTICINO	CARRARA	DECORATI*
PUNTO	•	piccolo	piccolo	piccolo	piccolo	piccolo	piccolo	piccolo	piccolo
		medio	medio	medio	medio	medio	medio	medio	medio
VIRGOLA	,	piccola	piccola	piccola	piccola	piccola	piccola	piccola	piccola
		media	media	media	media	media	media	media	media
ACCENTO	ˆ	piccolo	piccolo	piccolo	piccolo	piccolo	piccolo	piccolo	piccolo
		medio	medio	medio	medio	medio	medio	medio	medio
TRATTINO	—	piccolo	piccolo	piccolo	piccolo	piccolo	piccolo	piccolo	piccolo
		grande	grande	grande	grande	grande	grande	grande	grande
ACCENTO CIRCONF.	ˆ	piccolo							
		grande							
ACCENTO SPECIALE	ˆ	ridotto	piccolo	piccolo					
		piccolo							
ACCENTO CIRCONF. SPECIALE	ˆ	ridotto							
		piccolo							
AUMENTO PER COMPOSIZIONE EPIGRAFICI		fino a 6 cm							

*PER DECORATI INTENDIAMO LE SEGUENTI COLORAZIONI: COLLEZIONE FIORE LINE DA PAG. 110.

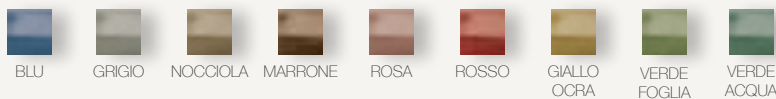



A B C D

E F G H I

J K L M

N O P Q

R S T U V

W X Y Z





1 2 3 4 5 6 7 8 9 0

À Ω ★ + • , ' —





VILVO

		BRONZO  CENTIMETRI
LETTERE		3 4 5
NUMERI		3 4
STELLA E CROCE		3
CARATTERI SPECIALI		3

PUNTEGGIATURA

		BRONZO 
PUNTO		piccolo grande
VIRGOLA		piccola
ACCENTO		piccolo
TRATTINO PICCOLO		piccolo

AUMENTO PER COMPOSIZIONE EPIGRAFI

ARMONY



caratteri lettres lettering letras schriftzeichen



ARMONY		BRONZO
		CENTIMETRI
LETTERE	B	2,5 3 4 5
NUMERI	5	2,5 3 4
STELLA E CROCE	*+	2,5 3
CARATTERI SPECIALI	Ł	3 4 5
PUNTEGGIATURA		BRONZO
PUNTO	.	medio
VIRGOLA	,	media
TRATTINO	-	medio
ACCENTO CIRCONF.	^	medio

AUMENTO PER COMPOSIZIONE EPIGRAFI



A B C D

E F G H I

J K L M

N O P Q

R S T U V

W X Y Z

1 2 3 4 5 6 7 8 9 0

* + . , ' -



ELITE

		BRONZO
		CENTIMETRI
LETTERE		2,5
		3
		4
		5
		6
NUMERI		2,5
		3
		4
STELLA E CROCE		2,5
		3
		4

PUNTEGGIATURA

		BRONZO
PUNTO		piccolo grande
VIRGOLA		piccola grande
ACCENTO		piccolo
TRATTINO		piccolo grande

AUMENTO PER COMPOSIZIONE EPIGRAFI



Aa Bb Cc Dd Ee

Ff Gg Hh Ii Jj Kk

Ll Mm Nn Oo Pp

Qq Rr Ss Tt Uu

Vv Ww Xx Yy Zz

1 2 3 4 5 6 7 8 9 0

Łł Øø * † . - , ' ¨



DUPLO



DUPLO

BRONZO
CENTIMETRI

LETTERE MAIUSCOLE	B	4,5
LETTERE MINUSCOLE	b	3
NUMERI	5	2,5 3
STELLA E CROCE n E m	*† m n	2,5 3
CARATTERI SPECIALI	ŁłØø	3 4,5

PUNTEGGIATURA

BRONZO

PUNTO	•	medio
TRATTINO	—	medio
APOSTROFO VIRGOLA	’	medio
ACCENTO	ˆ	medio

AUMENTO PER COMPOSIZIONE EPIGRAFI

ROMANO BRONZO



caratteri lettres lettering letras schriftzeichen

A B C D

E F G H I

J K L M

N O P Q

R S T U V

W X Y Z

1 2 3 4 5 6 7 8 9 0

Æ Ø Å Ω Ł † ‡ ★ †

., ’ — . - ^ - v / —





ROMANO BRONZO

ROMANO

		BRONZO CENTIMETRI	AUTOADESIVO CENTIMETRI		
LETTERE	B	1,5	2,5		
		2	3		
		2,5	4		
		3	5		
		4			
		5			
		6			
		8			
		10			
		12			
		15			
		NUMERI	5	1,5	2,5
				2	3
2,5	4				
3					
4					
5					
8					
10					
12					
15					
STELLA E CROCE	★✝	2	2,5		
		2,5	3		
		3	4		
		4			
		5			
CARATTERI SPECIALI	ΑΘΑΩ	2,5			
		3			
	✝	2,5			
	L	2,5			
		3			
		4			
		5			
P	6				
	8				

PUNTEGGIATURA

		BRONZO	AUTOADESIVO
PUNTO		piccolo medio grande	piccolo medio
VIRGOLA		piccola media grande	piccola media
ACCENTO		piccolo medio grande	piccolo
TRATTINO		piccolo	piccolo
TRATTINO		cm 3 cm 4 cm 5	
ACCENTO CIRCONF.		piccolo medio grande	
TILDE		media	
PUNTO SPECIALE		piccolo medio	
TRATTINO SPECIALE		piccolo grande	
ACCENTO SPECIALE		ridotto piccolo medio	
ACCENTO CIRCONF. SPECIALE		ridotto piccolo medio	
AUMENTO PER COMPOSIZIONE EPIGRAFI		fino a 6 cm	

ROMANO ORO



caratteri lettres lettering letras schriftzeichen

A B C D

E F G H I

J K L M

N O P Q

R S T U V

W X Y Z

1 2 3 4 5 6 7 8 9 0

Ł † ★ ‡ • , ¸ — † ‹

ROMANO ORO



LETTERE	B	2,5 3 4 5
NUMERI	5	2,5 3 4
STELLA E CROCE	★ †	2,5 3 4
CARATTERI SPECIALI	†	2,5
	Ł	2,5 3

PUNTEGGIATURA



PUNTO	•	piccolo medio
VIRGOLA	,	piccola media
ACCENTO	¸	piccolo medio
TRATTINO	—	piccolo
ACCENTO SPECIALE	†	ridotto piccolo medio
	Ł	ridotto piccolo medio

AUMENTO PER COMPOSIZIONE EPIGRAFI



ROMANO CLASSIC

A B C D

E F G H I

J K L M

N O P O

R S T U V

W X Y Z

1 2 3 4 5 6 7 8 9 0

★ ✚ • , ¨ — — —

ROMANO CLASSIC

CLASSIC



CENTIMETRI

LETTERE

B

2
2,5
3
4
5
6

NUMERI

5

2
2,5
3
4
5

STELLA E CROCE



2
2,5
3
4
5

PUNTEGGIATURA

CLASSIC



PUNTO



piccolo
medio
grande

VIRGOLA



piccola
media

ACCENTO



piccolo
medio

TRATTINO



piccolo

TRATTINO



cm 3
cm 4

ACCENTO CIRCONE.



piccolo

AUMENTO PER COMPOSIZIONE EPIGRAFI

ROMANO

CIRILLICO BALCANICO



caratteri lettres lettering letras scharfzeichen

А Б В Г Г Д

10 15 11 17 18 19

Е Ё Ж З И

13 21 23 25 27

І ІЙ К Л М

30 28 29 31 33 35

Н О П Р С

36 37 39 40 12

Т У Ф Х Ц

42 44 46 48 50

Ч Ш Щ Ъ

52 54 56 58

Ы Ь Э Ю Я

60 62 64 66 68

1 2 3 4 5 6 7 8 9 0



CIRILLICO BALCANICO		BRONZO
		CENTIMETRI
LETTERE	В	3 5
NUMERI	5	3 4 5
PUNTEGGIATURA		BRONZO
PUNTO	•	medio
VIRGOLA	,	media
ACCENTO CIRCONF.	^	medio
TRATTINO	—	medio



MUNDIAL CIRILLICO BALCANICO



10 15 11 17 18 19



13 21 23 25 27



30 28 29 31 33 35



36 37 39 40 12



42 44 46 48 50



52 54 56 58



60 62 64 66 68

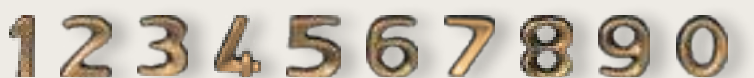

CIRILLICO BALCANICO

BRONZO

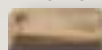

CENTIMETRI

LETTERE		3 5
NUMERI		3 5

PUNTEGGIATURA

BRONZO

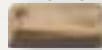

PUNTO		piccolo medio
VIRGOLA		piccolo medio
ACCENTO CIRCONF.		piccolo grande
TRATTINO		piccolo medio



Aa a Bb Cc Dd

Ee e Ff Gg Hh

Ii i Jj Kk Ll

Mm Nn Oo o Pp

Qq Rr Ss Tt

Uu u Vv Ww Xx



CORSIVO INSTANT

Yy Zz

i L. * †

1 2 3 4 5

6 7 8 9 0



Esempio di applicazione su barretta

1985
n. 1901
15. 12. 1994
m. 15. 11. 1993



CORSIVO INSTANT



caratteri lettres lettering letras schriftzeichen



CORSIVO INSTANT

		BRONZO	ORO	DARK	UNIBLANC	CLASSIC	BOTTICINO	CARRARA
		CENTIMETRI	CENTIMETRI	CENTIMETRI	CENTIMETRI	CENTIMETRI	CENTIMETRI	CENTIMETRI
LETTERE MAUSCOLE iniziali e terminali		5,5	5,5	5,5	5,5	5,5	5,5	5,5
		7,5	7,5	7,5				
		16	16	16				
LETTERE MINUSCOLE intermedie e terminali		2,5	2,5	2,5	2,5	2,5		
		3	3	3	3	3	3	3
		4	4	4				
		8	8	8				
NUMERI sciolti e su asta		SU ASTA	SU ASTA	SU ASTA	SU ASTA	SU ASTA		
		2,5	2,5	2,5	2,5	2,5		
STELLA E CROCE scioltte e su asta		2,5	2,5	2,5	2,5	2,5		
		3	3	3	3	3		
m sciolta e su asta		SCIOLTO	SCIOLTO	SCIOLTO	SCIOLTO	SCIOLTO	SCIOLTO	SCIOLTO
		2,5	2,5	2,5	2,5	2,5		
		3	3	3	3	3	3	3
n sciolta e su asta		4	4	4				
CARATTERI SPECIALI		2,5						
		3						
	4							
		3						
4								
	5,5							
	7,5							

Richiamo di abbinamento: 5,5 con 2,5 e 3 minuscole
7,5 con 4 minuscole
16 con 8 minuscole

Il Corsivo Istant è disponibile, su ordinazione, nelle seguenti colorazioni speciali:



AUMENTO PER COLORAZIONI



CORSIVO INSTANT



	BRONZO	ORO	DARK	UNIBLANC	CLASSIC	BOTTICINO	CARRARA
BARRETTE PER NUMERI da cm 2,5 - 3	10	10	10	10	10		
	17,5	17,5	17,5	17,5	17,5		
	23	23	23	23	23		
	31	31	31	31	31		
BARRETTE PER NUMERI da cm 4	13,5	13,5	13,5				
	24	24	24				
	31	31	31				
	40,5	40,5	40,5				

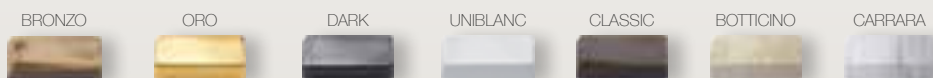

PUNTEGGIATURA		BRONZO	ORO	DARK	UNIBLANC	CLASSIC	BOTTICINO	CARRARA
GAMBETTE		2,5	2,5	2,5	2,5	2,5		
		3	3	3	3	3	3	3
		4	4	4				
PUNTO		piccolo	piccolo	piccolo	piccolo	piccolo	piccolo	piccolo
		grande	grande	grande				
PUNTO PER ASTA		2,5	2,5	2,5	2,5	2,5		
		3	3	3	3	3		
ACCENTO		medio	medio	medio	medio	medio	medio	medio
VIRGOLA		medio	medio	medio	medio	medio	medio	medio
TRATTINO		medio	medio	medio	medio	medio	medio	medio
TRATTINO LINEARE		piccolo						
		grande						
ACCENTO CIRCONF.		piccolo						
		grande						
PUNTO ALLUNGATO		piccolo						
ACCENTO CIRCONF. SPECIALE		piccolo						

CARATTERISTICHE TECNICHE

Características técnicas

Technical features

Características técnicas

Technische merkmale

Montaggio Lettere fornite sciolte con micro viti a scomparsa



Montage
Lettres fournies séparément avec micro vis à tête plate.

Montage
Letras suministradas sueltas con pequeños tornillos.

Mounting
Loose letters supplied with vanishing micro-screws.

Montierung
Lose Buchstaben, geliefert mit weit zurückstehenden Mikroschrauben.

Composizione delle epigrafi

Le lettere iniziali minuscole, sono completate da una gambetta. Le lettere terminali sono predisposte senza gancio.
Precisare al momento dell'ordine le lettere desiderate



Composition des épigraphes
Les lettres initiales minuscules sont complétées par un délié.
Les lettres terminales sont disponibles sans attache.
Préciser la quantité désirée.

Composición del epígrafe
La letra inicial minúscula se completa con una gambeta.
La letra final no dispone de enlace.
Precisar en los pedidos la cantidad.

Inscription composition
Initial small letters, complete with tails. Terminal letters come without hooks. Indicate in the order letters required.

Inschriftenkompositionen
Die kleinen Anfangsbuchstaben sind mit einem Grundstrich versehen. Die Endbuchstaben sind ohne Haken angefertigt. Bitte präzisieren Sie die erforderliche Menge!

Composizione delle date

I numeri possono essere impiegati con o senza barrette. Con le barrette 1, 2, 3, 4, 5, sono predisposti con l'attacco alla base del carattere.
Senza le barrette 1, 2, 3, 4, 5, che vengono impiegati liberi, sono predisposti con i tradizionali 2 perni.
Precisare alla richiesta il tipo di esigenza.

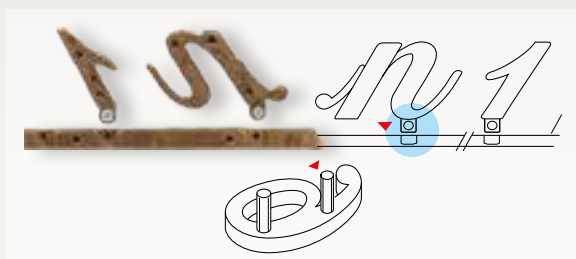

Composition des dates. Les chiffres peuvent être utilisés avec ou sans barres. Avec les barres 1, 2, 3, 4, 5, sont adaptées avec attache à la base du caractère. Sans les barres Les lettres 1, 2, 3, 4, 5, qui sont librement appliquées, sont munie de rivet. Préciser lors de la demande le type de votre choix.

Date composition. Numbers may be used with or without underbars. With underbars 1, 2, 3, 4, 5, come with attachment to the base of the character. Without underbars 1, 2, 3, 4, 5, which are applied freestanding, are supplied with traditional pins. State type needed at time of demand.

Composición de la fecha. Los números están predisuestos con o sin barra. Con barra 1, 2, 3, 4, 5, están predisuestos con sujeción especial en la base del carácter. Sin barra 1, 2, 3, 4, 5, que se utilizan sueltos, están predisuestos con el tradicional pernio.
Por tanto debe precisar en el pedido el tipo que se quiere utilizar.

Datenkompositionen. Die Zahlen können mit oder ohne Stäbe verwendet werden. Mit Stäbe 1, 2, 3, 4, 5, sind mit einem Verbindungsstück am Boden des Schriftzeichens angefertigt. Ohne Stäbe Die Buchstaben 1, 2, 3, 4, 5, die lose verwendet werden, sind mit einem Stift versehen. Bei Anfrage geben Sie bitte die Art des Bedarfs an!



ITALICO

*Dante
Alighieri*
★ 1265 † 1321

LETTERE E NUMERI
spessore mm 6
CENTIMETRI

1,5
2
2,5
3
4

ITALICO SATINATO

*Amedeo
Modigliani*
1884 1920

LETTERE E NUMERI
spessore mm 6
CENTIMETRI

1,5
2
2,5
3
4

ITALICO GOLD

*Amedeo
Modigliani*
1884 1920

LETTERE E NUMERI
spessore mm 6
CENTIMETRI

1,5
2
2,5
3
4

SENESE

DANTE ALIGHIERI
★ 1265 † 1321

LETTERE E NUMERI
spessore mm 6
CENTIMETRI

2
2,5
3
4
5

SENESE SATINATO

**AMEDEO
MODIGLIANI**
1884 1920

LETTERE E NUMERI
spessore mm 6
CENTIMETRI

2
2,5
3
4
5

SENESE GOLD

**AMEDEO
MODIGLIANI**
1884 1920

LETTERE E NUMERI
spessore mm 6
CENTIMETRI

2
2,5
3
4
5

UMBRO

Robert Schumann
1810-1856

LETTERE E NUMERI
spessore mm 6
CENTIMETRI

1,5
2
2,5
3
4

UMBRO SATINATO

Robert Schumann
1810-1856

LETTERE E NUMERI
spessore mm 6
CENTIMETRI

1,5
2
2,5
3
4

UMBRO GOLD

Robert Schumann
1810-1856

LETTERE E NUMERI
spessore mm 6
CENTIMETRI

1,5
2
2,5
3
4

Numeri, Stella e Croce,
sono disponibili sciolti,
su asta o in date congiunte

Nell'ordine specificare solo la
misura delle lettere minuscole,
le maiuscole sono dimensionate
in proporzione.

Il prezzo di listino è lo stesso
sia per le lettere minuscole che
per le maiuscole

Le misure indicate corrispondono
alle lettere minuscole



FIRMA

Roberta
Simone

Spessore mm 3
CENTIMETRI

cm 2 - 2,5 - 3

Per dimensioni diverse da quelle indicate il prezzo è a preventivo

Il prodotto viene realizzato previa scansione elettronica della firma: si richiede, possibilmente, di consegnare il manoscritto su carta bianca.



CARATTERI UNIBLOCK BASTONE

TERMANI
CRISTIANO
1747 2011

LETTERE E NUMERI
spessore mm 3
CENTIMETRI

1,5
2
2,5
3



CARATTERI UNIBLOCK ROMANO

SIMONI
ROBERTA
1951 2000

LETTERE E NUMERI
spessore mm 3
CENTIMETRI

2
2,5
3

CARATTERI



caratteri lettres lettering letras schriftzeichen

Classico

LETTERE E NUMERI Spessore mm. 3 CENTIMETRI	1,5	4
	2	5
	2,5	6
	3	8
		10

Elegante

LETTERE E NUMERI Spessore mm. 3 CENTIMETRI	1,5	4
	2	5
	2,5	6
	3	8
		10

Futura

LETTERE E NUMERI Spessore mm. 3 CENTIMETRI	1,5	4
	2	5
	2,5	6
	3	8
		10

Inglese

LETTERE E NUMERI Spessore mm. 3 CENTIMETRI	1,5	4
	2	5
	2,5	6
	3	8
	3,5	10

Mediterraneo

LETTERE E NUMERI Spessore mm. 3 CENTIMETRI	1,5	4
	2	5
	2,5	6
	3	8
	3,5	10

LETTERE E NUMERI Spessore mm. 5 CENTIMETRI	2,5	3,5
	3	4
		5

ROMANO
TRAFORATO

LETTERE E NUMERI Spessore mm. 3 CENTIMETRI	2,5	5
	3	8
	4	10
		12



CARATTERI

Giarda
*28-10-2016

LETTERE E NUMERI spessore mm 3 CENTIMETRI	LETTERE E NUMERI spessore mm 5 CENTIMETRI
2	2,5
2,5	3
3	4
4	5
5	
6	
8	
10	

ABCDEFGHIJKLMNOPQRSTUVWXYZ
abcdefghijklmnopqrstuvwxyz *+n.m.1234567890

Amalfe
*28-10-2016

LETTERE E NUMERI spessore mm 3 CENTIMETRI	LETTERE E NUMERI spessore mm 5 CENTIMETRI
2	2,5
2,5	3
3	4
4	5
5	
6	
8	
10	

ABCDEFGHIJKLMNOPQRSTUVWXYZ
abcdefghijklmnopqrstuvwxyz *+n.m.1234567890

I numeri fino a cm.4 sono ordinabili solo congiunti.

TUTTI I CARATTERI TRAFORATI SONO DISPONIBILI ANCHE, SU ORDINAZIONE, NELLE SEGUENTI COLORAZIONI:

DECORATI FIORE LINE
DA PAG. 110

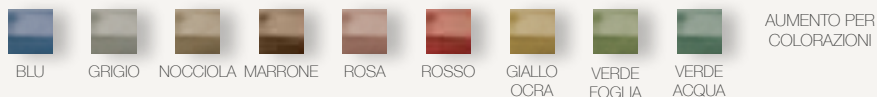

COLORAZIONI SPECIALI



CARATTERI



caratteri lettres lettering letras schriftzeichen

ITALICO Alfabeto Completo

A B C D E F
G H I J K L M
N O P Q R S
T U V W X Y Z
a b c d e f g h i j k l m
n o p q r s t u v w x y z
☆ + 1 2 3 4 5 6 7 8 9 . -

SENESE Alfabeto Completo

A B C D E F
G H I J K L M
N O P Q R S
T U V W X Y Z
☆ + 1 2 3 4 5 6 7 8 9 0

UMBRO Alfabeto Completo

A B C D E F
G H I J K L M
N O P Q R S
T U V W X Y Z
a b c d e f g h i j k l m
n o p q r s t u v w x y z
☆ + 1 2 3 4 5 6 7 8 9 0

CORSIVO CLASSICO Alfabeto Completo

A B C D E F
G H I J K L M
N O P Q R S
T U V W X Y Z
a b c d e f g h i j k l m
n o p q r s t u v w x y z
† ☆ 0 1 2 3 4 5 6 7 8 9



CORSIVO

CORSIVO ELEGANTE

Alfabeto Completo

A B C D E F
G H I J K L M
N O P Q R S
T U V W X Y Z

a b c d e f g h i j k l m
n o p q r s t u v w x y z

† ☆ 0 1 2 3 4 5 6 7 8 9

CORSIVO FUTURA

Alfabeto Completo

A B C D E F
G H I J K L M
N O P Q R S
T U V W X Y Z

a b c d e f g h i j k l m
n o p q r s t u v w x y z

† ☆ 0 1 2 3 4 5 6 7 8 9

CORSIVO INGLESE

Alfabeto Completo

A B C D E F
G H I J K L
M N O P Q R S
T U V W X Y Z

a b c d e f g h i j k l m
n o p q r s t u v w x y z

☆ † 0 1 2 3 4 5 6 7 8 9

CORSIVO MEDITERRANEO

Alfabeto Completo

A B C D E F
G H I J K L
M N O P Q R S
T U V W X Y Z

a a b c d e e f g h
i j k l m n o p
q r s t u v w x y z

☆ † 1 2 3 4 5 6 7 8 9 0

TERMANI
CRISTIANO
1747 2011

CARATTERI
INOX

B

B

B

ROMANO

TRAFORATO INOX

caratteri lettres lettering letras schriftzeichen

A B C D

E F G H I

J K L M

N O P Q

R S T U V

W X Y Z

1 2 3 4 5 6 7 8 9 0

€ ★ ✚ - . , '



ROMANO
TRAFORATO INOX
Spessore mm 3



		INOX CENTIMETRI
LETTERE	B	2,5 3 4 5
NUMERI	5	2,5 3
STELLA E CROCE	★ ✚	2,5 3
CARATTERI SPECIALI	€	2,5 3 4 5

PUNTEGGIATURA



PUNTO	•	medio
VIRGOLA	,	medio
ACCENTO	ˆ	medio
TRATTINO	—	medio

ROMANO ACCIAIO

A B C D

E F G H I

J K L M

N O P Q

R S T U V

W X Y Z

1 2 3 4 5 6 7 8 9 0

☆ † ◻ ◂ ◃ ◄ ◅



ROMANO ACCIAIO



		INOX CENTIMETRI
LETTERE	B	2
		2,5
		3,5
		4,5
		6
NUMERI	5	2
		2,5
		3,5
STELLA E CROCE	☆ †	2
		2,5
		3,5

PUNTEGGIATURA



PUNTO	◻	medio
VIRGOLA ACCENTO	◂	medio
TRATTINO	◃	medio

AUMENTO PER COMPOSIZIONE EPIGRAFI

MUNDIAL

ACCIAIO INOX FUSO

caratteri lettres lettering letras schriftzeichen



MUNDIAL INOX



		INOX CENTIMETRI
LETTERE	B	2,5 3 4 5 6
NUMERI	5	2,5 3
STELLA E CROCE		2,5 3

PUNTEGGIATURA



PUNTO		medio
VIRGOLA ACCENTO		medio
TRATTINO		medio

FIRMA ACCIAIO INOX



Spessore mm 3
CENTIMETRI

cm 2 - 2,5 - 3

Per dimensioni diverse da quelle indicate il prezzo è a preventivo

Il prodotto viene realizzato previa scansione elettronica della firma: si richiede, possibilmente, di consegnare il manoscritto su carta bianca.

CARATTERI UNIBLOCK BASTONE ACCIAIO INOX



LETTERE E NUMERI
spessore mm 3
CENTIMETRI

1,5
2
2,5
3

CARATTERI UNIBLOCK ROMANO ACCIAIO INOX



LETTERE E NUMERI
spessore mm 3
CENTIMETRI

2
2,5
3

Albatros

Inglese



Amalfi

Elegant

PRESTIGE

CARATTERI

ACCIAIO INOX

ALBATROS CORSIVO INOX

LETTERE E NUMERI Spessore mm. 3 CENTIMETRI	1,5	4
	2	5
	2,5	6
	3	8
PUNTEGGIATURA		10

Alfabeto Completo

A B C D E F G H I J K L M
 N O P Q R S T U V W X Y Z
 a b c d e f g h i j k l m n o p q r s t u v w x y z
 ☆ † 0 1 2 3 4 5 6 7 8 9

CORSIVO INGLESE INOX

LETTERE E NUMERI Spessore mm. 3 CENTIMETRI	1,5	4
	2	5
	2,5	6
	3	8
	3,5	10
PUNTEGGIATURA		

Alfabeto Completo

A B C D E F G H I J K L M
 N O P Q R S T U V W X Y Z
 a b c d e f g h i j k l m n o p q r s t u v w x y z
 ☆ † 0 1 2 3 4 5 6 7 8 9

AMALFI INOX

LETTERE E NUMERI Spessore mm. 3 CENTIMETRI	2	5
	2,5	6
	3	8
	4	10
	PUNTEGGIATURA	

Alfabeto Completo

A B C D E F G H I J K L M
 N O P Q R S T U V W X Y Z
 a b c d e f g h i j k l m n o p q r s t u v w x y z
 ☆ † 0 1 2 3 4 5 6 7 8 9

ELEGANT INOX

LETTERE E NUMERI Spessore mm. 3 CENTIMETRI	1,5	4
	2	5
	2,5	6
	3	8
PUNTEGGIATURA		10

Alfabeto Completo

A B C D E F G H I J K L M
 N O P Q R S T U V W X Y Z
 a b c d e f g h i j k l m n o p q r s t u v w x y z
 ☆ † 1 2 3 4 5 6 7 8 9 0

PRESTIGE INOX

LETTERE E NUMERI Spessore mm. 3 CENTIMETRI	1,5	4
	2	5
	2,5	6
	3	8
PUNTEGGIATURA		10

Alfabeto Completo

A B C D E F G H I J K L M
 N O P Q R S T U V W X Y Z
 ☆ † 1 2 3 4 5 6 7 8 9 0

LIBRI E PERGAMENE

I tuoi cari

*André
Breton*

1896 - 1966

*"Je cherche
l'or du temps"*



Patina Artistica

P 21 873/18 cm ±18x27

P 21 873/26 cm ±27x41

I 21 862/18 cm ±18x27

I 21 862/26 cm ±27x41

I caratteri sono compresi nel prezzo

Per il libro h. cm 18 sono previste solo le seguenti cornici:
cm 6x8 - cm 7x9 - cm 8x10



P 19 003/06 cm 6x8

P 19 003/07 cm 7x9

P 19 003/08 cm 8x10

P 19 003/09 cm 9x12

P 19 003/11 cm 11x15



P 21 007/09 cm 9x12

P 21 007/10 cm 10x15

P 21 007/11 cm 11x15

Caratteri a rilievo disponibili

Lettres disponibles:

Characters available:

Caracteres disponibles:

Verfügbare Buchstaben:

Corsivo
VITTORIANO

BASTONE
William

ROMANO
Francescano



È possibile applicare lettere in carattere bastone o incidere in carattere Corsivo, Bastone o Romano.

Le applicazioni e le incisioni non sono comprese nel prezzo.
 Incisione Alla lettera (oltre le 40 lettere, sconto 50%)
 Applicazione in carattere bastone alla lettera

I 21 369/25
cm ±25x42,5

I 21 369/35
cm ±37x50



P 21 666/12
cm ±12x21

P 21 666/17
cm ±17x27

I 21 677/12
cm ±12x21

I 21 677/17
cm ±17x27



P 21 702/12
cm ±12x21

P 21 702/17
cm ±17x27

I 21 713/12
cm ±12x21

I 21 713/17
cm ±17x27

Cornici disponibili

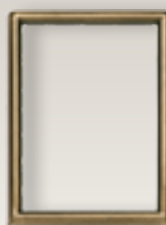

Esempio di applicazione a terreno

Per il libro h. cm 12 sono previste solo le seguenti cornici: cm 6x8 - cm 7x9

- P 19 768/06** cm 6x8
- P 19 768/07** cm 7x9
- P 19 768/08** cm 8x10
- P 19 768/09** cm 9x12

- P 21 015/07** cm 7x9
- P 21 015/08** cm 8x10
- P 21 015/09** cm 9x12



Le incisioni possono essere in carattere:

Les gravures peuvent être réalisées soit en:

Engravings may be in:

Las grabaciones pueden ser en:

Die Gravierungen können sowohl in:

Corsivo

BASTONE

ROMANO



Patina Artistica

P T0191
cm 15x10

P T0192
cm 20x11

P T0179
cm 21x15

P T0180
cm 28x20

P T0181
cm 35x25

I caratteri sono compresi nel prezzo

Caratteri a rilievo disponibili

Lettres disponibles:

Characters available:

Caracteres disponibles:

Verfügbare Buchstaben:

Corsivo
VITTORIANO

BASTONE
William

ROMANO
Francescano



PERGAMENE

Le incisioni possono essere in carattere Corsivo, Bastone o Romano.

Les gravures peuvent être réalisées soit en caractères bâtons, romano.

Engravings may be in cursive, block letters or romano.

Las grabaciones pueden ser en caracter corsivo, bastón ó romano.

Die Praegungen können in Schreiftschrift, in Bastone oder Romano sein.



P 22 018/210
cm ±21x33

P 22 018/250
cm ±25x44

P 22 018/310
cm ±31x50

P 22 042/70
cm ±7x10

P 22 042/100
cm ±10x15

P 22 042/110
cm ±11x20

P 22 042/150
cm ±15x22

P 22 042/180
cm ±18x27

T 22 221/70
cm ±7x10

T 22 221/100
cm ±10x15

T 22 221/110
cm ±11x20

T 22 221/150
cm ±15x22

T 22 221/180
cm ±18x27

T 22 221/210
cm ±21x33

T 22 221/250
cm ±25x44

T 22 221/310
cm ±31x50



P 22 000/75
cm ±7,5X14

P 22 000/100
cm ±10X17

P 22 000/105
cm ±10,5X20

P 22 000/140
cm ±14X24



P 22 240/140
cm ±14X20

P 22 240/180
cm ±18,5X27



Cuore

P 32 558/08
cm ±8X8

P 32 558/09
cm ±9X9

P 32 558/10
cm ±10X10



Cuore Inciso

P 33 001/10
cm ±10X10



Cuore Inciso

P 33 003/10
cm ±10X10



Cuori Allacciati

P 32 567/15
cm ±15X18

Le applicazioni e le incisioni non sono comprese nel prezzo.
Incisione alla lettera (oltre le 40 lettere, sconto 50%)
Applicazione in carattere bastone alla lettera

PERGAMENE

CON INCISIONI COMMEMORATIVE



pergamene parchemins scrolls pergaminos pergamente

P 22 064/70
cm ±7X10

P 22 064/100
cm ±10X15



P 22 060/70
cm ±7X10

P 22 060/100
cm ±10X15

P 22 086/70
cm ±7X10

P 22 086/100
cm ±10X15



P 22 075/70
cm ±7X10

P 22 075/100
cm ±10X15

P 22 109/70
cm ±7X10

P 22 109/100
cm ±10X15



P 22 097/70
cm ±7X10

P 22 097/100
cm ±10X15

P 22 144/70
cm ±7X10

P 22 144/100
cm ±10X15



P 22 133/70
cm ±7X10

P 22 133/100
cm ±10X15

P 22 122/70
cm ±7X10

P 22 122/100
cm ±10X15



P 22 111/70
cm ±7X10

P 22 111/100
cm ±10X15

P 22 244/70
cm ±7X10

P 22 244/100
cm ±10X15



P 22 233/70
cm ±7X10

P 22 233/100
cm ±10X15



PERGAMENE

CON INCISIONI COMMEMORATIVE

P 22 030/75
cm ±7,5X14

P 22 030/100
cm ±10X17



P 22 040/75
cm ±7,5X14

P 22 040/100
cm ±10X17

P 22 120/75
cm ±7,5X14

P 22 120/100
cm ±10X17



P 22 150/75
cm ±7,5X14

P 22 150/100
cm ±10X17

P 22 235/75
cm ±7,5X14

P 22 235/100
cm ±10X17



P 22 280/75
cm ±7,5X14

P 22 280/100
cm ±10X17

P 22 350/75
cm ±7,5X14

P 22 350/100
cm ±10X17



P 22 370/75
cm ±7,5X14

P 22 370/100
cm ±10X17

P 22 450/75
cm ±7,5X14

P 22 450/100
cm ±10X17



P 22 490/75
cm ±7,5X14

P 22 490/100
cm ±10X17

P 22 610/75
cm ±7,5X14

P 22 610/100
cm ±10X17



P 22 650/75
cm ±7,5X14

P 22 650/100
cm ±10X17

TARGHE
COMMÉMORATIVE

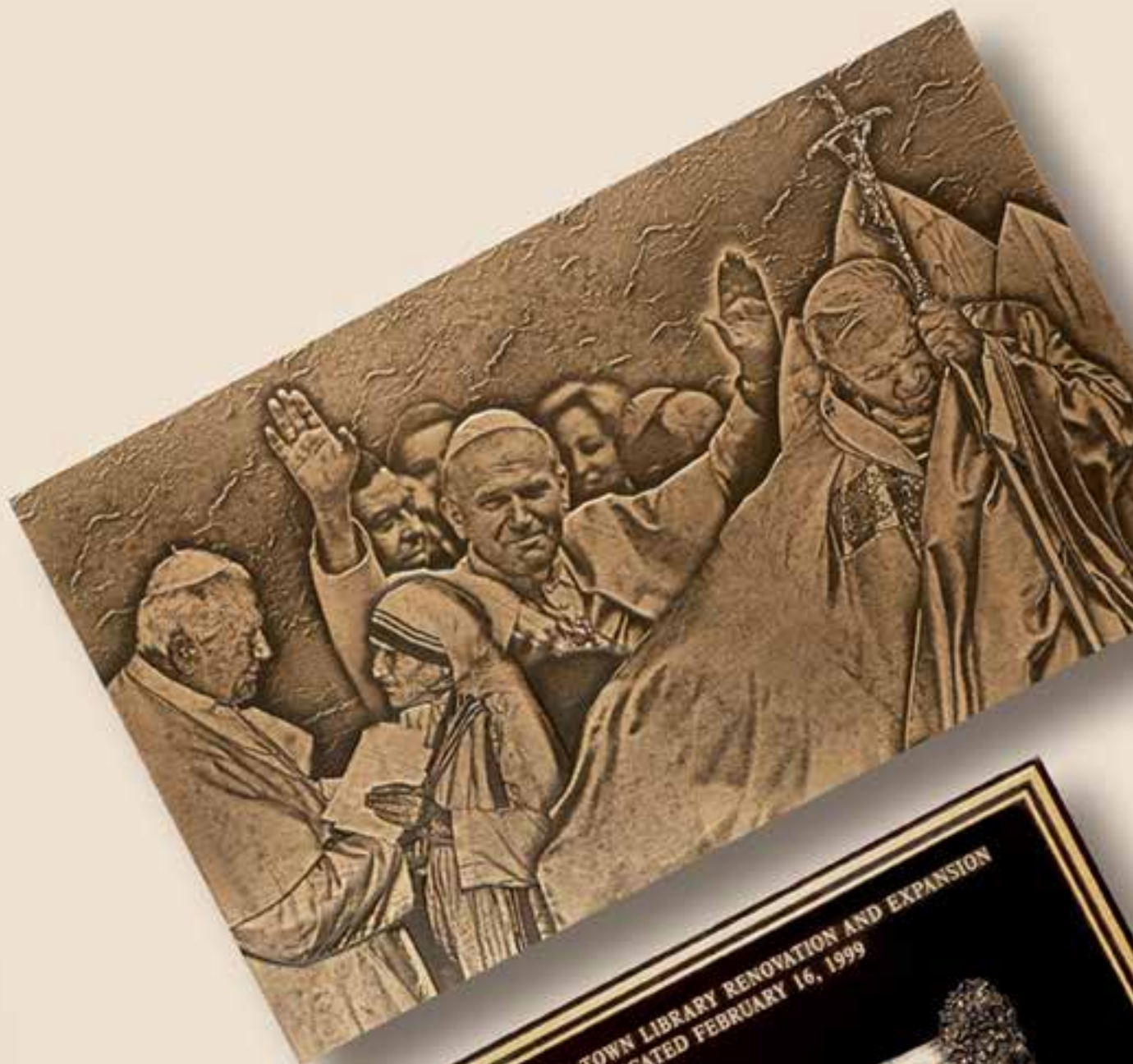

THE TOPSFIELD TOWN LIBRARY RENOVATION AND EXPANSION
DEDICATED FEBRUARY 16, 1999



Made possible by
The Citizens of Topsfield
The George L. Gould Trust Fund
The Massachusetts Board of Library Commissioners
Selectmen: Stephen Clark, Joseph Iarocci, Janet K
Trustees: Karen Dow, Audrey Iarocci, Catherine M
Martha Morrison, Joan Panella, Walter Rob
Building Committee: Ralph Castagna, Scott Dow, Ma
Library Director: Sheila Glowacki
Architect: A. Anthony Tappe Associates
General Contractor: G & R Construct
Project Manager: ANADAC

Targhe in bronzo fuso “Momenti Magici”.

Le immagini dei momenti più significativi direttamente fuse in Bronzo 87 con uno straordinario effetto fotografico.



Guida alla realizzazione delle targhe "Momenti Magici".

1) Selezione foto



2) Elaborazione della bozza



3) Fusione della Targa

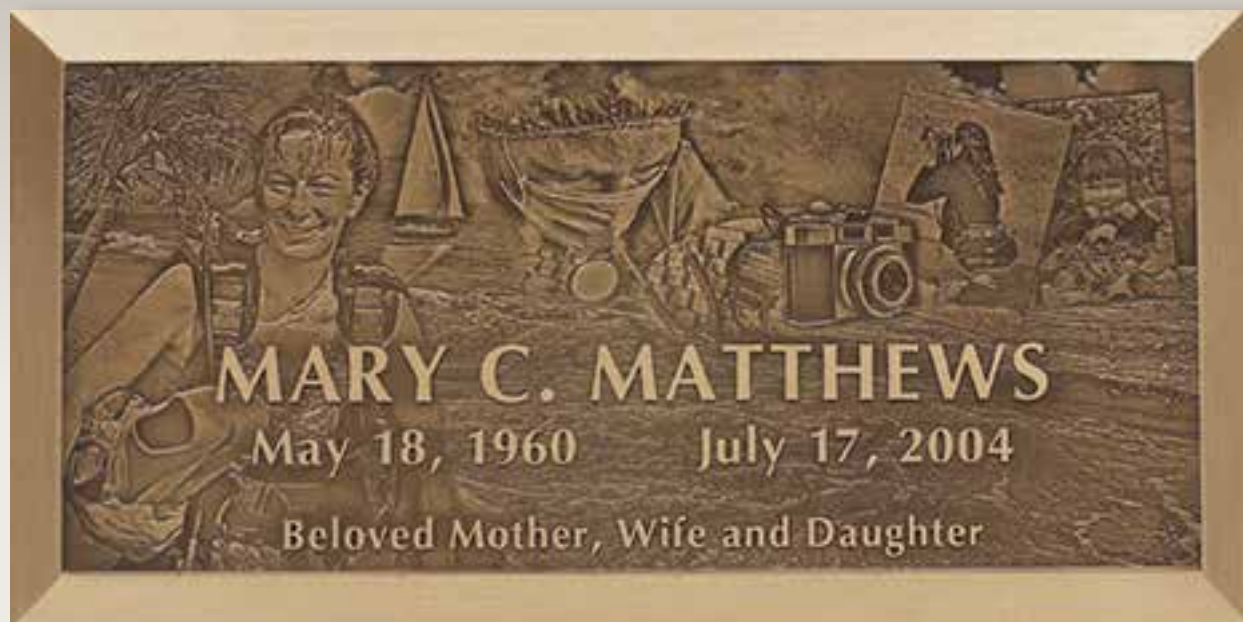

Le targhe "Momenti Magici" possono essere realizzate in qualsiasi forma nella misura minima consigliata di cm 20 x cm 30.

al cm² (per targa fino a 500 cm²)
 al cm² (per targa da 501 cm² a 1000 cm²)
 al cm² (per targa oltre 1000 cm²)



Targhe per loculi e monumenti con patina artistica

Plaques pour niches funéraires et monuments avec patine artistique

Plaques for niches and mausoleums with an artistic patina

Placas para nichos y monumentos con acabado artístico

Plaketten mit künstlerischer patina für grabnischen und grabmäler



P T0133
cm 36x26



P T0015
cm 36x26



P T0135
cm 36x26



P T0134
cm 36x26



P T0023
cm 36x22



P T0178
cm 18x12

P T0025
cm 37x24



P T0017
cm 36x27



P T0177
cm 24x12
P T0024
cm 43x23



P T0176
cm 18x12
P T0016
cm 36x26



Ondulata
P T0234
cm 27x18
Esempio di Carattere
Francescano



Concava spigoli rotondi
P T0237
cm 27x18
Esempio di Carattere
William



Concava spigoli vivi
P T0238
cm 27x18
Esempio di Carattere
Vittoriano

Caratteri a rilievo disponibili

Lettres disponibles:

Characters available:

Caracteres disponibles:

Verfügbare Buchstaben:

Corsivo
VITTORIANO

BASTONE
William

ROMANO
Francescano

A richiesta si possono avere anche con applicazione a terreno



T0310
cm 8x4



T0265
cm 8x4

Quantità minima richiesta: 50 pezzi.
Quantité minimum exigée: 50 pièces.
Minimum quantity asked: 50 pieces.
Cantidad minima de pedido: 50 un.
Erforderliche Mindestmenge: 50 Stück.



Il "Sistema Targhe Caggiati" consente di realizzare targhe in BRONZO 87 personalizzate adatte ad ogni tipo di esigenza.

Le "Système Plaques Caggiati" permet de réaliser des plaques en BRONZE 87 personnalisées, adaptées à tout type d'exigence.

The "Caggiati Plate System" creates personalised plates in BRONZE 87 suitable for all requirements.

El "Sistema Placa Caggiati" permite realizar placas de BRONZE 87 personalizadas y apropiadas para cualquier necesidad.

Das "Schildersystem Caggiati" erlaubt die Herstellung von Schildern aus BRONZE 87 genau nach Kundenwunsch, sie eignen sich für jeden Bedarf.

I vari elementi scelti per la composizione della targa (bordi, colori, caratteri), sono compresi nel prezzo di listino.



Dimensioni in cm		Dimensions en cm		Dimensions in cm		Dimensiones en cm		Größe in cm	
T0005 15x10	T0053 30x15	T0068 40x20	T0083 50x20	T0136 60x10	T0190 70x45	T0252 85x65	T0257 100x50		
T0029 15x15	T0055 30x20	T0007 40x28	T0085 50x25	T0137 60x15	T0139 75x10	T0142 90x10	T0258 100x70		
T0043 20x10	T0057 30x25	T0070 40x40	T0013 50x30	T0138 60x20	T0140 75x15	T0143 90x15	T0259 105x90		
T0045 20x20	T0059 30x30	T0073 45x20	T0088 50x35	T0094 60x25	T0141 75x20	T0144 90x20	T0260 120x90		
T0011 22x15	T0061 35x15	T0075 45x25	T0090 50x40	T0096 60x30	T0247 75x30	T0253 90x50			
T0048 25x10	T0006 35x23	T0077 45x30	T0092 50x45	T0098 60x35	T0248 75x46	T0254 90x60			
T0050 25x25	T0063 35x30	T0081 45x38		T0100 60x40	T0249 75x50	T0255 90x75			
T0012 27x18	T0065 35x35	T0079 45x45		T0102 60x45	T0250 75x60	T0256 90x90			
				T0189 60x50	T0251 75x75				
				T0246 60x60					



Dimensioni in cm	Dimensions en cm	Dimensions in cm	Dimensiones en cm	Größe in cm	Dimensioni in cm	Dimensions en cm	Dimensions in cm	Dimensiones en cm	Größe in cm
T0105 ø30	T0183 ø45	T0261 ø60	T0262 ø75	T0263 ø90	T0264 ø120	T0026 17x10	T0109 25x17	T0001 30x20	T0116 36x26



Bordi Contour Border Borde Rand



Senza bordo
 Sans contour - Without border
 Sin borde - Ohne Rand



Linea singola
 Ligne simple - Single line
 Línea única - Einzelne Linie



Linea doppia
 Ligne double - Double line
 Línea doble - Doppelte Linie



Bordo smussato
 solo per forme rettangolari o quadrate
 Ligne simple, arrondie - Single line bevel edge
 Línea única, viselada - Einzelne Linie, Abrundung

Colori
 parti incassate

Couleurs
 Parties encaissées

Colors
 The base portion

Colores
 Partes interiores

Farbe
 Eingebetteten Teilen

RAL 1001	RAL 2000	RAL 5013	RAL 6001	RAL 7001	RAL 8017	PATINA ARTISTICA
RAL 1003	RAL 3001	RAL 5015	RAL 6003	RAL 7011	RAL 8019	
RAL 1013	RAL 3003	RAL 5017	RAL 6005	RAL 7015	RAL 9011	
RAL 1015	RAL 3005		RAL 6028		RAL 9003	

Caratteri disponibili

Lettres disponibles:

Characters available:

Caracteres disponibles:

Verfügbare Buchstaben:

Corsivo
VITTORIANO

BASTONE
William

ROMANO
Francescano

Per la realizzazione di progetti personalizzati fuori misura standard, richiedere una quotazione ai nostri uffici commerciali.

Pour la réalisation de projets personnalisés, veuillez adresser votre demande de devis à nos bureaux commerciaux.

Ask our sales offices for an estimate for your personalised projects.

Para la realización de proyectos personalizados, pida un presupuesto a nuestras oficinas comerciales.

Bei der Ausführung von personalisierten Projekten bitten wir Sie einen Kostenvorschlag in einer unserer Verkaufsabteilungen anzufordern.

INCASSI



INCASSI



incassi vases et
lamps
encastrables

insert vases
and lamps for
monuments

incrustados
para
monumentos

versenkbare
vase und
lampen



13 018/10P
cm ±10x16



13 516/17
cm ±17, ±ø13,5



13 057/4
cm ±4, ±ø21



10 186/15
cm ±15, ±ø21



13 512/22
cm ±22x11, ±ø7,5



13 003/12
cm ±12x16



13 107/7
cm ±7, ±ø13,5



13 012/04
cm ±4x19



13 551/15
cm ±17x23

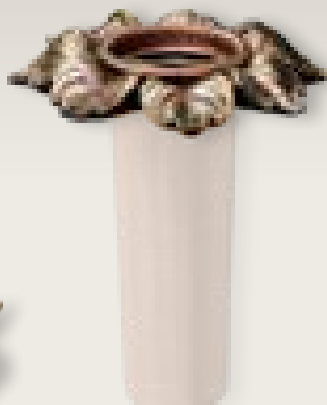

13 001/03R
13 001/03P
cm ±3x22



13 533/17
cm ±17x22

incassi

vases et
lamps
encastrables

insert vases
and lamps for
monuments

incrustados
para
monumentos

versenkbare
vase und
lampen



INCASSI



13 031/09R
cm :9x16
con anello dorato

13 036/09R
cm :9x16
con anello bronzo



13 625/21
cm :21x12,5x9
con anello dorato

13 623/21
cm :21x12,5x9
con anello bronzo



12 111/12
cm :12x23
con anello dorato

12 112/12
cm :12x23
con anello bronzo



13 245/95
cm :9,5x16



13 746/21
cm :21x11,5x6,5



13 000/07R
cm :6,5x15,5x10,5



13 011/20
cm :19,5x11,5x5,5



13 055/07P
cm :7,5x24x22



13 065/25
cm :24,5x24x22



13 020/03R
cm :3x15,5



13 034/17
cm :16,5x11,5

INCASSI



incassi vases et
lamps
encastrables

insert vases
and lamps for
monuments

incrustados
para
monumentos

versenkbare
vase und
lampen



T 13 043/09R ⓘ
T 13 043/09P ⓘ
cm :9x16



T 13 634/21
cm :21x12,↔ø9



T 12 113/12 ⓘ
cm :12x23

CLASSIC



T 13 636/21
cm :21x12,↔ø9



T 12 118/12 ⓘ
cm :12x23



T 13 046/09 ⓘ
cm :9x16



T 13 363/06 ⓘ
cm :6,5↔16



T 13 921/20
cm :19,5x12,↔ø9

incassi
vases et
lampes
encastrables

insert vases
and lamps for
monuments

incrustados
para
monumentos

versenkbare
vase und
lampen



INCASSI



T 13 422/11R

T 13 422/11P
cm ±11x17



T 13 511/12
cm ±12,5x18,5



T 13 609/10
cm ±10,5x18,5



T 13 165/04R

T 13 165/04P
cm ±4,5x18,5



T 13 187/55
cm ±5,5x16



T 13 666/16
cm ±16,5x11



T 13 077/04P
cm ±3,5x16



T 13 080/14
cm ±14x16

INCASSI



incassi vases et
lampes
encastrables insert vases
and lamps for
monuments incrustados
para
monumentos versenkbare
vase und
lampen



I 13 247/29R ⓘ

I 13 247/29P ⓘ
cm ±4,5x16



I 13 247/27R ⓘ

I 13 247/27P ⓘ
cm ±3,5x14



I 13 247/23 ⓘ

cm ±3,5x13



I 13 247/17 ⓘ

cm ±2,5x10



I 13 251/15 ⓘ
cm ±3,5x30x11



I 13 249/15R ⓘ
cm ±3,5x15,5x11



I 13 750/17 ⓘ
cm ±17x11



I 13 750/11 ⓘ
cm ±11,5x8



I 13 781/15 ⓘ
cm ±14,5x11x10



I 13 265/03R ⓘ
I 13 265/03P ⓘ
cm ±3,5x18x15,5



I 13 267/04 ⓘ
cm ±4,5x36x17



I 13 263/03 ⓘ
cm ±3,5x26,5x16,5

incassi vases et
lampes
encastrables

insert vases
and lamps for
monuments

incrustados
para
monumentos

versenkbare
vase und
lampen



INCASSI



13 820/10
cm ±9,5,±18,5x18,5



13 814/10
cm ±10,5,±18,5x18,5



13 128/05
cm ±5,5,±16x16



13 124/17
cm ±17,±11x11



13 822/04
cm ±3,5,±15,7x15,7



13 816/10
cm ±10,±18,5x18,5



13 088/11
cm ±10,5,±ø14



13 100/08P
cm ±8,±ø12,5



13 099/13
cm ±13,±ø14



13 138/04
cm ±4,5,±ø20

ILLUMINAZIONE





LAMPADE ELETTRICHE INCASSATE



lampade
elettriche
incassate

lampes
électriques
à encastrer

built-in
electric
lamps

lampara
eléctrica para
incrustar

elektrische
einbaulampen



Portina cristallo - rosa colorata

13 168/03
cm ±3,5x±12



Portina cristallo - orchidea gialla

13 167/03
cm ±3,5x±12



Portina cristallo - margherita verde

13 169/03
cm ±3,5x±12



Portina cristallo - rosa neutra

13 176/03
cm ±3,5x±12



Portina cristallo - orchidea neutra

13 175/03
cm ±3,5x±12



Portina cristallo - margherita neutra

13 177/03
cm ±3,5x±12



Portina vetro molato

13 102/06
cm ±2,5x±12

13 102/08
cm ±2,5x±12

13 102/10
cm ±2,5x±12

13 102/02
cm ±3x±12



Portina vetro pirex

13 130/02
cm ±3x±12



Portina cristallo - Cristo

13 131/05
cm ±6x±12



Portina

13 076/10
cm ±10x10

13 076/12
cm ±12x12



A RICHIESTA PORTACERO

96 007/0 cm ±8x±9

lampade
elettriche
incassate

lampes
électriques
à encastrer

built-in
electric
lamps

lampara
electrica para
incrustar

elektrische
einbaulampen



LAMPADE ELETTRICHE INCASSATE



Portina cristallo - Madonna

13 135/05
cm 16,4x12



Portina cristallo - Fiore grande

13 142/05
cm 16,4x12



Portina cristallo - Neutro

13 161/05
cm 16,4x12



Portina cristallo - Stella

13 163/05
cm 16,4x12



Portina cristallo

13 170/05
cm 16,4x12



Portina cristallo

13 178/05
cm 16,4x12



Portina cristallo

13 210/08
cm 13,5x12



Portina cristallo - Cristallo con iridescenza

13 225/08
cm 13,5x12



Portina cristallo

13 180/06
cm 14,4x12

13 180/08
cm 15,4x12

13 180/12
cm 16,4x12



Portina cristallo

13 195/06
cm 14,4x12

13 195/08
cm 15,4x12

13 195/12
cm 16,4x12

FIAMME VOTIVE

IN VETRO E CRISTALLO
LAVORATO A MANO

fiamme
in cristallo

flammas
en cristal

crystal
flames

llamas
de cristal

kristallgläser



98 150/0
cm ±9x5,5 → ø3,5
Per ossari



98 145/0
cm ±12x7 → ø5



98 128/0
cm ±12x9,5 → ø6



Boccioli di Rosa
98 039/0
cm ±10x6,5 → ø5



Rosa interno satinato
98 024/0
cm ±10x6,5 → ø5



Rosa
98 026/0
cm ±10x6,5 → ø5

fiamme
in cristallo

flammes
en cristal

crystal
flames

llamas
de cristal

kristallgläser

FIAMME VOTIVE

IN VETRO E CRISTALLO
LAVORATO A MANO



Rosa del Cuore
con cuore satinato

98 086/0
cm :7x10,4-ø5



Rosa del Cuore
satinata con cuore lucido

98 084/0
cm :7x10,4-ø5



Rosa

98 121/0
cm :10x8,4-ø5



Rosa

98 117/0
cm :10x8,4-ø5



Rosa

98 041/0
cm :10x7,4-ø5



Tulipano

98 133/0
cm :11,5x7,5-ø5

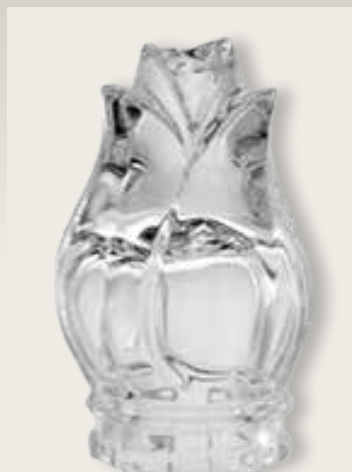

Bocciolo di Rosa

98 053/0
cm :9x6,4-ø4
Per ossari

FIAMME VOTIVE

IN CRISTALLO LAVORATO A MANO

fiamme
in cristallo

flammas
en cristal

crystal
flames

llamas
de cristal

kristallgläser



Calla

98 042/0
cm :10x6,5 → ø5



Calla interno satinato

98 040/0
cm :10x6,5 → ø5



Giglio

98 013/0
cm :9x7 → ø5



98 130/0
cm :12x9 → ø5



Crisantemo

98 017/0
cm :8x8 → ø5

fiamme
in cristallo

flammas
en cristal

crystal
flames

llamas
de cristal

kristallgläser

FIAMME VOTIVE

IN CRISTALLO LAVORATO A MANO



98 107/0
cm :11x7 ↗ ↘ ø5



98 109/0
cm :11x7 ↗ ↘ ø5



98 018/0
cm :12x7,5 ↗ ↘ ø5



98 115/0
cm :11x7 ↗ ↘ ø5



98 113/0
cm :11x7 ↗ ↘ ø5

FIAMME VOTIVE

IN CRISTALLO LAVORATO A MANO

fiamme
in cristallo

flammas
en cristal

crystal
flames

llamas
de cristal

kristallgläser



98 032/0
cm ±8x8,±5



98 019/0
cm ±8x8,±5



98 021/0
cm ±8x8,±5

fiamme
in cristallo

flammas
en cristal

crystal
flames

llamas
de cristal

kristallgläser

FIAMME VOTIVE

IN CRISTALLO LAVORATO A MANO



98 025/0
cm 8x8,5



98 038/0
cm 8x8,5



9 962/0
cm 6x6
ghiera senza fiamma

GHIERE PORTAFIAMMA



ghiere

embouts
reductions

ring
nuts

lamparas

kranze

Finitura
Bronzo



Diametro
cm 4

T 9 862/10 (con fiamma)

cm ±10,±ø6

T 9 927/02 (senza fiamma)

cm ±2,±ø6

Classic



T 9 960/10 (con fiamma)

cm ±10,±ø6

T 9 801/02 (senza fiamma)

cm ±2,±ø6

Dark



T 9 873/10 (con fiamma)

cm ±10,±ø6

T 9 918/02 (senza fiamma)

cm ±2,±ø6

Uniblanco



T 9 875/10 (con fiamma)

cm ±10,±ø6

T 9 933/02 (senza fiamma)

cm ±2,±ø6



Diametro
cm 5

T 9 912/13 (con fiamma)

cm ±13,±ø6,5

T 9 823/03 (senza fiamma)

cm ±2,5,±ø6,5



T 9 810/13 (con fiamma)

cm ±13,±ø6,5

T 9 820/03 (senza fiamma)

cm ±2,5,±ø6,5



T 9 916/13 (con fiamma)

cm ±13,±ø6,5

T 9 836/03 (senza fiamma)

cm ±2,5,±ø6,5



T 9 839/13 (con fiamma)

cm ±13,±ø6,5

T 9 932/03 (senza fiamma)

cm ±2,5,±ø6,5



Diametro
cm 6

T 9 802/17 (con fiamma)

cm ±17,±ø8

T 9 903/03 (senza fiamma)

cm ±3,±ø8



T 9 813/17 (con fiamma)

cm ±17,±ø8

T 9 830/03 (senza fiamma)

cm ±3,±ø8



T 9 812/17 (con fiamma)

cm ±17,±ø8

T 9 906/03 (senza fiamma)

cm ±3,±ø8



T 9 815/17 (con fiamma)

cm ±17,±ø8

T 9 907/03 (senza fiamma)

cm ±3,±ø8

ghiere

embouts
reductions

ring
nuts

lamparas

kranze



GHIERE PORTAFIAMMA

Botticino



T 9 890/10 (con fiamma)
cm ±10,±06

T 9 895/02 (senza fiamma)
cm ±2,±06

Carrara



T 9 954/02 (con fiamma)
cm ±10,±06

T 9 940/02 (senza fiamma)
cm ±2,±06

Diametro
cm 5



Finitura
Bronzo

T 9 852/13 (con fiamma)
cm ±13,±06

T 9 910/0 (senza fiamma)
cm ±1,5,±06

Finitura
Botticino



T 9 803/13 (con fiamma)
cm ±13,±06

T 9 807/0 (senza fiamma)
cm ±1,5,±06



T 9 880/13 (con fiamma)
cm ±13,±06,5

T 9 885/03 (senza fiamma)
cm ±2,5,±06,5



T 9 931/03 (con fiamma)
cm ±13,±06,5

T 9 946/03 (senza fiamma)
cm ±2,5,±06,5

Finitura
Bronzo



T 9 934/12 (con fiamma)
cm ±12,±08

T 9 804/02 (senza fiamma)
cm ±1,5,±08

Finitura
Carrara



T 9 950/0 (con fiamma)
cm ±13,±06

T 9 949/0 (senza fiamma)
cm ±1,5,±06



T 9 901/17 (con fiamma)
cm ±17,±08

T 9 896/04 (senza fiamma)
cm ±3,±08



T 9 908/03 (con fiamma)
cm ±17,±08

T 9 902/03 (senza fiamma)
cm ±3,±08

GHIERE PORTAFIAMMA
RIDUTTORE da ø cm 6 a cm 5

Finitura
Bronzo



T 9 911/0
cm ±1,5

CORNICI



PORTAFOTO VERTICALE



P 72 650/14

Portafoto verticale cm \pm 14x9,5
Fotoceramiche rettangolari cm 8x10
Acciaio brown senza luce

PORTAFOTO VERTICALE CON LUCE INTEGRATA

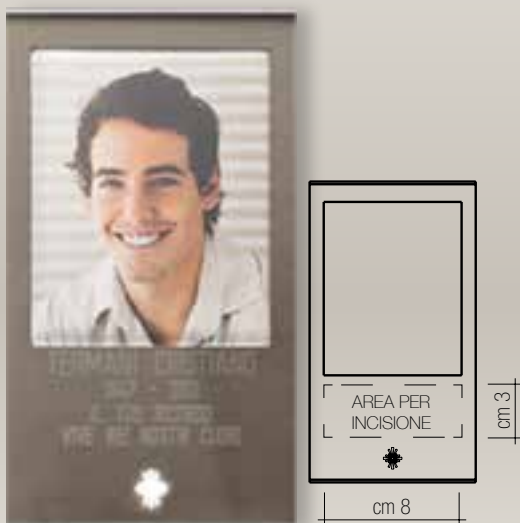

P 72 630/17

Portafoto verticale cm \pm 17x9,5
Fotoceramiche rettangolari cm 8x10
Acciaio brown con luce

La collezione di portafoto rappresenta una soluzione esteticamente innovativa, tecnicamente evoluta ed integrata per la rappresentazione di fotografia, dedica e illuminazione votiva nella decorazione funeraria per lapidi.

L'illuminazione è a led.

Le finiture dell'acciaio sono ottenute per elettrocolorazione per la migliore garanzia di durata nel tempo.

Incisione compresa nel prezzo

PORTAFOTO ORIZZONTALE CON LUCE INTEGRATA



P 72 610/12

Portafoto verticale cm \pm 12x23
Fotoceramiche rettangolari cm 8x10
Acciaio brown senza luce



CORNICI



P 19 005/09 cm 9x12
P 19 005/11 cm 11x15



P 21 010/09 cm 9x12
P 21 010/10 cm 10x15
P 21 010/11 cm 11x15



P 19 008/09 cm 9x12
P 19 008/11 cm 11x15



P 21 018/09 cm 9x12
P 21 018/10 cm 10x15
P 21 018/11 cm 11x15



P 19 024/09 cm 9x12
P 19 024/11 cm 11x15



P 21 025/09 cm 9x12
P 21 025/10 cm 10x15
P 21 025/11 cm 11x15



P 19 022/09 cm 9x12
P 19 022/11 cm 11x15



P 21 023/09 cm 9x12
P 21 023/10 cm 10x15
P 21 023/11 cm 11x15



P 19 063/07 cm 7x9
P 19 063/08 cm 8x10
P 19 063/09 cm 9x12
P 19 063/11 cm 11x15
P 19 063/13 cm 13x18



P 21 012/09 cm 9x12
P 21 012/10 cm 10x15
P 21 012/11 cm 11x15
P 21 012/13 cm 13x18



P 19 003/06 cm 6x8
P 19 003/07 cm 7x9
P 19 003/08 cm 8x10
P 19 003/09 cm 9x12
P 19 003/11 cm 11x15
P 19 003/13 cm 13x18



P 21 007/09 cm 9x12
P 21 007/10 cm 10x15
P 21 007/11 cm 11x15
P 21 007/13 cm 13x18



P 19 002/09 cm 9x12
P 19 002/11 cm 11x15



P 19 014/09 cm 9x12
P 19 014/11 cm 11x15
 Evolution Gold

CORNICI



cornici cadres frames portarretratos bilderrahmen



P 19 820/09 cm 9x12
P 19 820/11 cm 11x15



P 21 620/09 cm 9x12
P 21 620/10 cm 10x15



P 19 365/09 cm 9x12
P 19 365/11 cm 11x15
Verde pompeiano



P 21 228/09 cm 9x12
P 21 228/10 cm 10x15
Verde pompeiano



P 19 042/09 cm 9x12
P 19 042/11 cm 11x15



P 21 054/09 cm 9x12
P 21 054/11 cm 11x15



P 19 050/09 cm 9x12
P 19 050/11 cm 11x15



P 21 035/09 cm 9x12
P 21 035/11 cm 11x15



P 19 018/09 cm 9x12
P 19 018/11 cm 11x15



P 21 005/09 cm 9x12
P 21 005/11 cm 11x15

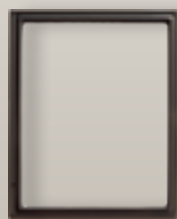

P 21 051/08 cm 8x10



P 19 020/08 cm 8x10



P 19 029/09 cm 9x12
P 19 029/11 cm 11x15
Verde pompeiano



P 21 021/09 cm 9x12
P 21 021/11 cm 11x15
Verde pompeiano



P 21 059/08 cm 8x10
Verde pompeiano



P 19 054/08 cm 8x10
Verde pompeiano



P 19 011/09 cm 9x12
P 19 011/11 cm 11x15
P 19 011/13 cm 13x18



P 21 001/09 cm 9x12
P 21 001/10 cm 10x15
P 21 001/11 cm 11x15
P 21 001/13 cm 13x18



P 19 013/09 cm 9x12
P 19 013/11 cm 11x15
P 19 013/13 cm 13x18
Classic



P 21 003/09 cm 9x12
P 21 003/10 cm 10x15
P 21 003/11 cm 11x15
P 21 003/13 cm 13x18
Classic



CORNICI



P 19 021/08 cm 8x10
P 19 021/09 cm 9x12
P 19 021/11 cm 11x15



P 21 004/09 cm 9x12
P 21 004/11 cm 11x15



P 19 032/09 cm 9x12
P 19 032/11 cm 11x15
 Terra Antica



P 21 044/09 cm 9x12
P 21 044/11 cm 11x15
 Terra Antica



P 19 106/09 cm 9x12
P 19 106/11 cm 11x15
 Verde pompeiano



P 21 305/09 cm 9x12
P 21 305/11 cm 11x15
 Verde pompeiano



P 19 045/09 cm 9x12
P 19 045/11 cm 11x15
 Blu



P 21 050/09 cm 9x12
P 21 050/11 cm 11x15
 Blu



P 19 559/09 cm 9x12
P 19 559/11 cm 11x15
P 19 559/13 cm 13x18
 Con filetto bronzo



P 21 451/09 cm 9x12
P 21 451/10 cm 10x15
P 21 451/11 cm 11x15
P 21 451/13 cm 13x18
 Con filetto bronzo



P 19 537/09 cm 9x12
P 19 537/11 cm 11x15
P 19 537/13 cm 13x18
 Con filetto dorato



P 21 473/09 cm 9x12
P 21 473/10 cm 10x15
P 21 473/11 cm 11x15
P 21 473/13 cm 13x18
 Con filetto dorato



P 19 801/09 cm 9x12
P 19 801/11 cm 11x15



P 21 586/09 cm 9x12
P 21 586/10 cm 10x15*
 *adattabile anche alla fotoceramica da cm 11x15



P 19 710/09 cm 9x12
P 19 710/11 cm 11x15
 Con filetto classic



P 21 920/09 cm 9x12
P 21 920/10 cm 10x15
P 21 920/11 cm 11x15
 Con filetto classic



P 19 787/09 cm 9x12
P 19 787/11 cm 11x15
P 19 787/13 cm 13x18
P 19 787/18 cm 18x24



P 21 564/09 cm 9x12
P 21 564/10 cm 10x15
P 21 564/11 cm 11x15
P 21 564/13 cm 13x18
P 21 564/18 cm 18x24



P 19 789/09 cm 9x12
P 19 789/11 cm 11x15
P 19 789/13 cm 13x18
P 19 789/18 cm 18x24
 Classic



P 21 566/09 cm 9x12
P 21 566/10 cm 10x15
P 21 566/11 cm 11x15
P 21 566/13 cm 13x18
P 21 566/18 cm 18x24
 Classic

CORNICI



cornici cadres frames portaritratos bilderrahmen



- P 19 377/07 cm 7x9
- P 19 377/08 cm 8x10
- P 19 377/09 cm 9x12
- P 19 377/11 cm 11x15
- P 19 377/13 cm 13x18
- P 19 377/18 cm 18x24



- P 21 256/07 cm 7x9
- P 21 256/08 cm 8x10
- P 21 256/09 cm 9x12
- P 21 256/10 cm 10x15
- P 21 256/11 cm 11x15
- P 21 256/13 cm 13x18
- P 21 256/18 cm 18x24



- P 19 768/06 cm 6x8
- P 19 768/07 cm 7x9
- P 19 768/08 cm 8x10
- P 19 768/09 cm 9x12
- P 19 768/11 cm 11x15
- P 19 768/13 cm 13x18
- P 19 768/18 cm 18x24



- P 21 015/07 cm 7x9
- P 21 015/08 cm 8x10
- P 21 015/09 cm 9x12
- P 21 015/10 cm 10x15
- P 21 015/11 cm 11x15
- P 21 015/13 cm 13x18
- P 21 015/18 cm 18x24



- P 19 823/07 cm 7x9
- P 19 823/09 cm 9x12
- P 19 823/11 cm 11x15
- P 19 823/13 cm 13x18
- P 19 823/18 cm 18x24



- P 19 058/05 cm 5x7
- P 19 058/07 cm 7x9
- P 19 058/08 cm 8x10
- P 19 058/09 cm 9x12
- P 19 058/11 cm 11x15



- P 19 355/05 cm 5x7
- P 19 355/06 cm 6x8
- P 19 355/07 cm 7x9
- P 19 355/08 cm 8x10
- P 19 355/09 cm 9x12
- P 19 355/11 cm 11x15
- P 19 355/13 cm 13x18
- P 19 355/18 cm 18x24



- P 21 212/08 cm 8x10
- P 21 212/09 cm 9x12
- P 21 212/10 cm 10x15
- P 21 212/11 cm 11x15
- P 21 212/13 cm 13x18
- P 21 212/18 cm 18x24



- P 19 101/09 cm 9x12
- P 19 101/11 cm 11x15
- P 19 101/13 cm 13x18



- P 21 081/09 cm 9x12
- P 21 081/10 cm 10x15
- P 21 081/11 cm 11x15
- P 21 081/13 cm 13x18



- P 19 790/09 cm 9x12
 - P 19 790/11 cm 11x15
 - P 19 790/13 cm 13x18
- Classic



- P 21 079/09 cm 9x12
 - P 21 079/10 cm 10x15
 - P 21 079/11 cm 11x15
 - P 21 079/13 cm 13x18
- Classic



- P 19 275/09 cm 9x12
- P 19 275/11 cm 11x15



- P 21 119/09 cm 9x12
- P 21 119/10 cm 10x15
- P 21 119/11 cm 11x15



- P 19 231/09 cm 9x12
- P 19 231/11 cm 11x15



- P 21 096/09 cm 9x12
 - P 21 096/10 cm 10x15
- adattabile anche alla fotoceramica da cm. 11x15



CORNICI



P 19 845/09 cm 9x12
P 19 845/11 cm 11x15



P 21 553/09 cm 9x12
P 21 553/10 cm 10x15*
 *Adattabile anche alla fotoceramica da cm 11x15



P 19 660/09 cm 9x12
P 19 660/11 cm 11x15



P 21 500/09 cm 9x12
P 21 500/10 cm 10x15



P 19 093/09 cm 9x12
P 19 093/11 cm 11x15
P 19 093/13 cm 13x18



P 21 176/09 cm 9x12
P 21 176/10 cm 10x15
P 21 176/13 cm 13x18



P 19 071/09 cm 9x12
P 19 071/11 cm 11x15



P 21 052/09 cm 9x12
P 21 052/10 cm 10x15
P 21 052/11 cm 11x15
P 21 052/13 cm 13x18



P 19 834/09 cm 9x12
P 19 834/11 cm 11x15



P 19 253/09 cm 9x12
P 19 253/11 cm 11x15



P 19 195/09 cm 9x12
P 19 195/11 cm 11x15



P 21 074/09 cm 9x12
P 21 074/10 cm 10x15



P 19 218/09 cm 9x12
P 19 218/11 cm 11x15



P 21 132/09 cm 9x12
P 21 132/10 cm 10x15
P 21 132/11 cm 11x15



P 19 715/07 cm 7x9
P 19 715/08 cm 8x10
P 19 715/09 cm 9x12
P 19 715/11 cm 11x15



P 19 116/09 cm 9x12
P 19 116/11 cm 11x15
P 19 116/13 cm 13x18



P 19 652/12 ø cm 12
P 19 652/14 ø cm 14
 Con filetto dorato



P 19 595/10 cm ø10
P 19 595/12 cm ø12



P 19 311/09 cm 9x12
P 19 311/11 cm 11x15
 Sporgente



P 21 234/09 cm 9x12
P 21 234/10 cm 10x15
P 21 234/11 cm 11x15
 Sporgente



Profilo delle cornici sporgenti

CORNICI



cornici cadres frames portarretratos bilderrahmen

P 25 089/14 cm ±14x14
con filetto dorato

P 25 012/20 cm ±20x20

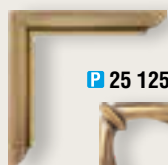

P 25 125/22 cm ±22x22

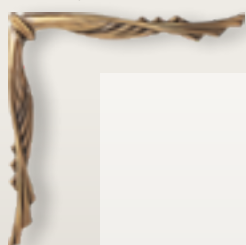

P 25 034/29 cm ±29x29

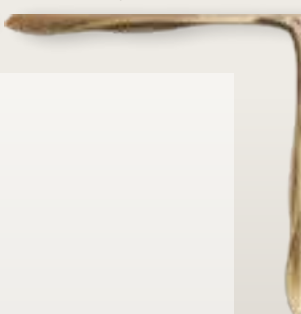

P 25 056/24 cm ±24x24

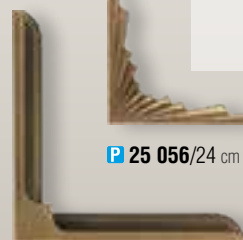

P 25 114/22 cm ±22x22

Astina di congiunzione

P 25 023/40 cm ±40x1,5

P 25 023/60 cm ±60x1,5

P 25 023/80 cm ±80x1,5



Snodo adattabile
per tutte le cornici
di nostra produzione
(fino a cm 11x15)

21 996/0
cm ±4,5 - attacco ø 4



Piastra per ogni
tipo di cornice
sia ovale che
rettangolare

T 21 043/19 cm 19x15,5 → 6x15,5
per cornici da cm 9/10/11

T 21 043/22 cm 22x18 → 6x18
per cornici da cm 13



T 19 017/09 cm 9x12

T 19 017/11 cm 11x15



T 21 034/09 cm 9x12

T 21 034/10 cm 10x15

T 21 034/11 cm 11x15



T 19 007/09 cm 9x12

T 19 007/11 cm 11x15



T 21 014/09 cm 9x12

T 21 014/10 cm 10x15

T 21 014/11 cm 11x15



T 19 366/09 cm 9x12

T 19 366/11 cm 11x15

T 19 366/13 cm 13x18

T 19 366/18 cm 18x24



T 21 223/09 cm 9x12

T 21 223/10 cm 10x15

T 21 223/11 cm 11x15

T 21 223/13 cm 13x18

T 21 223/18 cm 18x24



T 19 639/09 cm 9x12

T 19 639/11 cm 11x15

T 19 639/13 cm 13x18

T 19 639/18 cm 18x24



T 21 542/09 cm 9x12

T 21 542/10 cm 10x15

T 21 542/11 cm 11x15

T 21 542/13 cm 13x18

T 21 542/18 cm 18x24



CORNICI



19 602/09 cm 9x12
19 602/11 cm 11x15
19 602/13 cm 13x18
 Con filetto bronzo



21 646/09 cm 9x12
21 646/10 cm 10x15
21 646/11 cm 11x15
21 646/13 cm 13x18
 Con filetto bronzo



19 892/09 cm 9x12
19 892/11 cm 11x15
19 892/13 cm 13x18
 Con filetto dorato

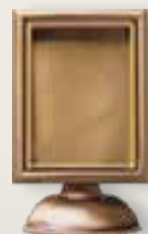

21 651/09 cm 9x12
21 651/10 cm 10x15
21 651/11 cm 11x15
21 651/13 cm 13x18
 Con filetto dorato



19 856/09 cm 9x12
19 856/11 cm 11x15
19 856/13 cm 13x18
19 856/18 cm 18x24



21 609/09 cm 9x12
21 609/10 cm 10x15
21 609/11 cm 11x15
21 609/13 cm 13x18
21 609/18 cm 18x24



19 181/09 cm 9x12
19 181/11 cm 11x15



21 161/09 cm 9x12
21 161/10 cm 10x15
21 161/11 cm 11x15



19 082/09 cm 9x12
19 082/11 cm 11x15



21 063/09 cm 9x12
21 063/10 cm 10x15
21 063/11 cm 11x15
21 063/13 cm 13x18



19 286/09 cm 9x12
19 286/11 cm 11x15



21 121/09 cm 9x12
21 121/10 cm 10x15
21 121/11 cm 11x15

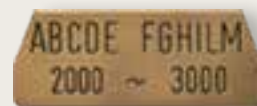

21 427/0
 cm 6x15
 Targhetta con lettere incise in Corsivo o Bastone posizionabile su ogni tipo di cornice.
 All'ordine specificare sempre la cornice desiderata.
 L'incisione non è compresa nel prezzo.

CROCI E
CROCEFISSI



CROCI



croci

croix

crosses

cruces

kreuze

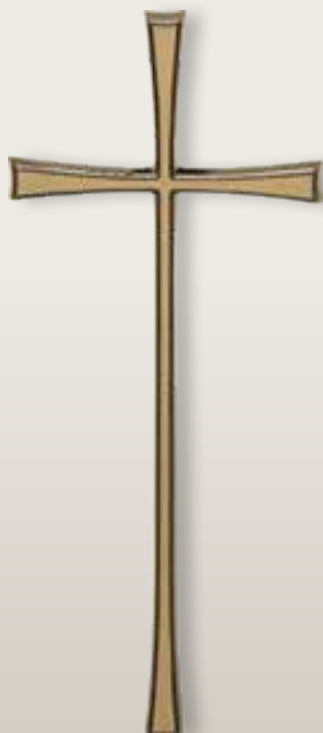

- P 23 017/15** cm ±15x7
- P 23 017/20** cm ±20x9,5
- P 23 017/25** cm ±25x11
- P 23 017/30** cm ±30x11,5
- P 23 017/40** cm ±40x15,5



- P 24 500/15** cm ±15x6
- P 24 500/20** cm ±20x7,5
- P 24 500/25** cm ±25x9,5



- P 24 510/15** cm ±15x6
- P 24 510/20** cm ±20x7,5
- P 24 510/25** cm ±25x9,5
Blu



- P 23 005/15** cm ±14,5x7
- P 23 005/20** cm ±19,5x9,5
Evolution



- P 23 010/15** cm ±14,5x7
- P 23 010/20** cm ±19,5x9,5
Evolution Gold



CROCI



- P 24 185/15** cm 15x7
- P 24 185/20** cm 20x8,5
- P 24 185/25** cm 25x11
Verde pompeiano



- P 24 160/15** cm 15x7
- P 24 160/20** cm 20x8,5
- P 24 160/25** cm 25x11
Bronzo scuro



- P 23 040/35** cm ±35x17
- P 23 040/40** cm ±40x20



- P 23 533/16** cm ±16x7,5
- P 23 533/20** cm ±20,5x10
- P 23 533/25** cm ±25x11
- P 23 533/30** cm ±30x12
- P 23 533/40** cm ±40x16
- P 23 533/52** cm ±52x19

CROCI



croci

croix

crosses

cruces

kreuze



- P 23 118/30** cm ±30x12
- P 23 118/40** cm ±40x15



- P 23 117/20** cm ±20x10,5
- P 23 117/30** cm ±30x12
- P 23 117/40** cm ±40x13,5



- P 23 030/15** cm ±15x9,5
- P 23 030/20** cm ±20x11
- P 23 030/25** cm ±25x13,5
- P 23 030/30** cm ±30x13,5
- P 23 030/40** cm ±40x18



- P 23 338/20** cm ±20x8
- P 23 338/30** cm ±30x12,5
- P 23 338/40** cm ±40x16
- P 23 338/50** cm ±50x20



- P 24 215/15** cm ±15x7
- P 24 215/20** cm ±20x8,5
- P 24 215/25** cm ±25x11
- P 24 215/30** cm ±30x13
- P 24 215/40** cm ±40x16

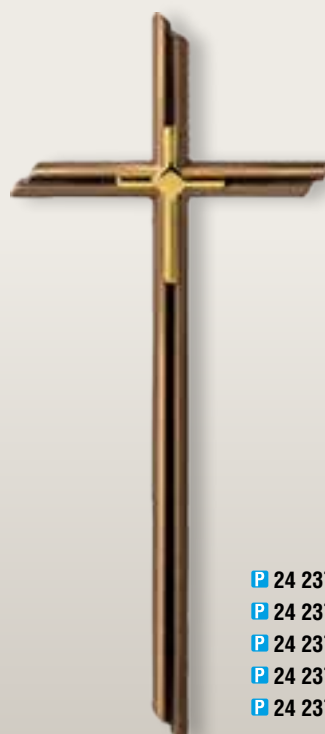

- P 24 237/15** cm ±15x7
- P 24 237/20** cm ±20x8,5
- P 24 237/25** cm ±25x11
- P 24 237/30** cm ±30x13
- P 24 237/40** cm ±40x16
con fregio dorato



- P 23 000/40** cm ±40x20



- P 23 320/30** cm ±30x13
- P 23 320/40** cm ±40x17,5
- P 23 320/50** cm ±50x20

CROCI



croci

croix

crosses

cruces

kreuze



- P 23 296/12** cm ±12x6,5
- P 23 296/15** cm ±15x8
- P 23 296/20** cm ±20x10
Finitura Classic



- P 23 293/12** cm ±12x6,5
- P 23 293/15** cm ±15x8
- P 23 293/20** cm ±20x10
- P 23 293/25** cm ±25x12
- P 23 293/30** cm ±30x14
- P 23 293/35** cm ±35x16
- P 23 293/50** cm ±50x17
- P 23 293/65** cm ±65x26
- P 23 293/80** cm ±80x26



- P 23 497/10**
cm ±10x10



- P 22 053/30**
cm ±3x4,5
- P 22 053/65**
cm ±6,5x8



P 24 320/40 cm ±40x20



P 24 322/40 cm ±40x20
con fregio dorato



P 24 324/40 cm ±40x20
con rosa



P 23 770/20 cm ±20x11,5

CROCI



croci

croix

crosses

cruces

kreuze



P 23 210/25 cm ±25x14
Verde Pompeiano



P 23 200/25 cm ±25x14



P 24 830/12 cm ±12x6,5
P 24 830/20 cm ±20x11



P 24 840/20 cm ±20x11



CROCI



P 23 031/20 cm ±20x14,5



P 23 041/20 cm ±20x14,5
Cristallo con iridescenza

CROCI



croci

croix

crosses

cruces

kreuze



P 23 147/45 cm :45x23



P 23 002/40 cm :40x16



P 23 001/40 cm :40x16



Sezione 15x5

P 23 351/15 cm :15x5,5

P 23 351/20 cm :20x6

P 23 351/25 cm :25x7,5

P 23 351/30 cm :30x8

Sezione 20x5

P 23 351/40 cm :40x10

P 23 351/50 cm :50x11

P 23 351/60 cm :60x12

P 23 351/80 cm :80x14

P 23 351/100 cm :100x15

P 23 351/120 cm :120x15



P 23 247/18 cm ±18x10



P 23 269/15 cm ±15x8
P 23 269/20 cm ±20x11,5
P 23 269/30 cm ±30x16



P 23 311/15 cm ±15x7,5
P 23 311/20 cm ±19,5x9,5
Finitura Classic



P 23 316/15 cm ±15x7,5
P 23 316/20 cm ±19,5x9,5
P 23 316/28 cm ±28x14,5
P 23 316/35 cm ±35x15
P 23 316/50 cm ±48,5x24

CROCI



croci

croix

crosses

cruces

kreuze



P 23 019/40 cm ±40,5x22



P 23 054/38 cm ±38x14



P 23 236/70 cm ±70x41



P 23 178/30 cm ±31x19,5



P 23 250/34 cm ±34x26,5



P 23 134/17 cm ±17x17



- P 23 098/8** cm ±8x4
- P 23 098/10** cm ±10x5
- P 23 098/12** cm ±12x6
- P 23 098/15** cm ±15x8
- P 23 098/20** cm ±20x10
- P 23 098/25** cm ±25x13
- P 23 098/30** cm ±30x16

CROCI



croci

croix

crosses

cruces

kreuze



P 24 157/40
cm ±40x16



P 23 004/40
cm ±40x16

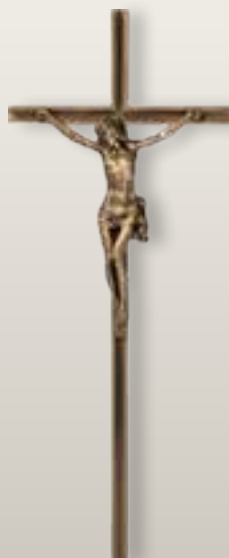

P 23 003/40
cm ±40x16



P 23 145/45
cm ±45x23



P 24 060/40
cm ±40x21,5



P 24 897/17
cm ±17x9



P 23 418/30
cm ±30x16

P 23 418/35
cm ±35x17,5



P 23 300/25
cm ±25x14



CROCI



P 23 050/15
cm ±15x9,5

P 23 050/20
cm ±20x11

P 23 050/25
cm ±25x13,5



P 24 298/40
cm ±40x16

P 24 298/50
cm ±50x20



P 23 373/15
cm ±15x8

P 23 373/20
cm ±20x10

P 23 373/25
cm ±25x12

P 23 373/30
cm ±30x14

P 23 373/35
cm ±35x16

P 23 373/50
cm ±50x17



P 23 349/15
cm ±15x8

P 23 349/20
cm ±20x10

P 23 349/25
cm ±25x12

P 23 349/30
cm ±30x14

P 23 349/35
cm ±35x16

P 23 349/50
cm ±50x17

P 23 349/30
cm ±30x14

P 23 349/35
cm ±35x16

P 23 349/40
cm ±40x17

P 23 349/50
cm ±50x17

con cristo dorato



P 23 431/15
cm ±15x5,5

P 23 431/20
cm ±20x6

P 23 431/25
cm ±25x7,5

P 23 431/30
cm ±30x8

P 23 431/40
cm ±40x10



P 23 026/40
cm ±40x20



P 23 119/20
cm ±20x10,5

P 23 119/30
cm ±30x12

P 23 119/40
cm ±40x13,5

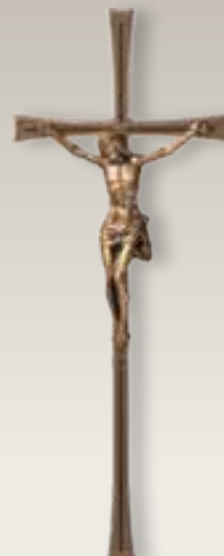

P 23 395/16
cm ±16x7,5

P 23 395/20
cm ±20,5x10

P 23 395/25
cm ±25x11

P 23 395/30
cm ±30x12

P 23 395/30
cm ±30x12

P 23 395/40
cm ±40x16

P 23 395/50
cm ±52x19

P 23 395/52
cm ±52x19

CROCI



croci

croix

crosses

cruces

kreuze



P 23 852/40
cm 40x16
con uccellino



P 23 896/40
cm 40x16
con uccellini



P 23 839/40
cm 40x16
con uccellini



P 23 715/40
cm 40x16
con giglio



P 23 657/40
cm 40x16
con stelle alpine



P 24 113/40
cm 40x16
con rosa



P 24 124/40
cm 40x16
con rosa



P 24 146/40
cm 40x16
con uccellini



P 24 168/40
cm 40x16
con spiga



P 23 919/40
cm 40x16
con ibisco



CROCI



P 23 794/40
cm :40x16
con viole del pensiero



P 23 772/40
cm :40x16
con uva



P 23 613/40
cm :40x16
con spiga



P 23 817/40
cm :40x16
con edera



P 23 874/40
cm :40x16
con tulipano



P 23 453/20
cm :20x10

P 23 453/25
cm :25x12

P 23 453/35
cm :35x16

P 23 453/50
cm :50x17
con rose



P 23 475/40
cm :40x16

P 23 475/50
cm :50x20
con rose



P 23 599/25
cm :25x11

P 23 599/30
cm :30x12

P 23 599/40
cm :40x16

P 23 599/52
cm :52x19
con rose



P 23 577/40
cm :40x16

P 23 577/52
cm :52x19
con rosa



P 23 340/40
cm :40x20

CROCI



croci

croix

crosses

cruces

kreuze



- P 24 294/50**
cm +50x25,5
- P 24 294/65**
cm +65x35
- P 24 294/75**
cm +75x35
con fregio dorato



- P 24 396/50**
cm +50x25,5
- P 24 396/65**
cm +65x35
- P 24 396/75**
cm +75x35



- P 24 281/50**
cm +50x25,5
- P 24 281/65**
cm +65x35
- P 24 281/75**
cm +75x35
con fregio dorato



- P 24 374/50**
cm +50x25,5
- P 24 374/65**
cm +65x35
- P 24 374/75**
cm +75x35



CROCI



- ○
- P 24 419/50**
cm :50x25,5
- P 24 419/65**
cm :65x35
- P 24 419/75**
cm :75x35
con rose



- ◡
- P 24 272/50**
cm :50x25,5
- P 24 272/65**
cm :65x35
- P 24 272/75**
cm :75x35



- P 24 853/77**
cm :78x37
- P 24 853/97**
cm :97x48



- P 24 875/97**
cm :97x43



- P 23 258/97**
cm :97x52

CROCI



croci

croix

crosses

cruces

kreuze



24 306/69
cm :69x25,5,↔,∅12,5

24 306/80
cm :80x35,↔,∅14,5

24 306/95
cm :95x35,↔,∅14,5
con fregio dorato

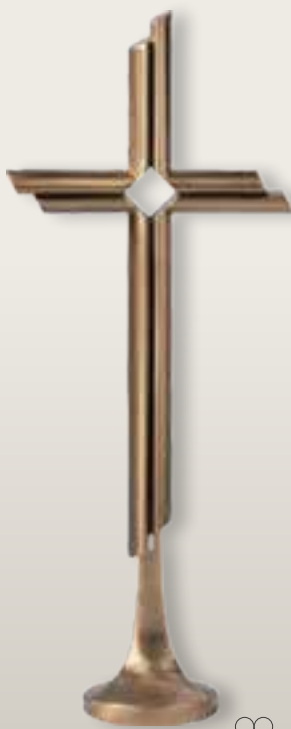

24 283/69
cm :69x25,5,↔,∅12,5

24 283/80
cm :80x35,↔,∅14,5

24 283/95
cm :95x35,↔,∅14,5



23 330/34
cm :34x13,↔,5,5x6,5

23 330/44
cm :44x17,5,↔,5,5x6,5

23 330/54
cm :54x20,↔,7x8



23 305/70
cm :70x26,↔,8,5x12

23 305/85
cm :85x26,↔,8,5x12



24 454/70 cm :70x26,↔,8,5x12

24 454/85 cm :85x26,↔,8,5x12
con Cristo e rose



24 385/69 cm :69x25,5,↔,∅12,5

24 385/95 cm :95x35,↔,∅14,5
con rose



24 363/69 cm :69x25,5,↔,∅12,5

24 363/95 cm :95x35,↔,∅14,5
con Cristo e rose



CROCI



23 327/55
cm ±55x24↔8,5x15



24 831/105
cm ±105x43↔17x10



24 818/82
cm ±82x37↔16x9,5
24 818/105
cm ±105x48↔17x10



23 036/127
cm ±127x44↔17x16

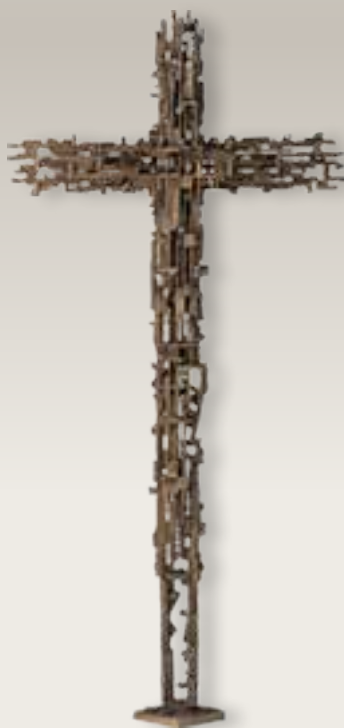

24 066/133
cm ±133x63↔12,5x12,5

CROCEFISSI



crocefissi

crucifix

crucifixes

crucos

kruzifixe



P 30 020/58
cm 58x27
Fuso a Cera Persa

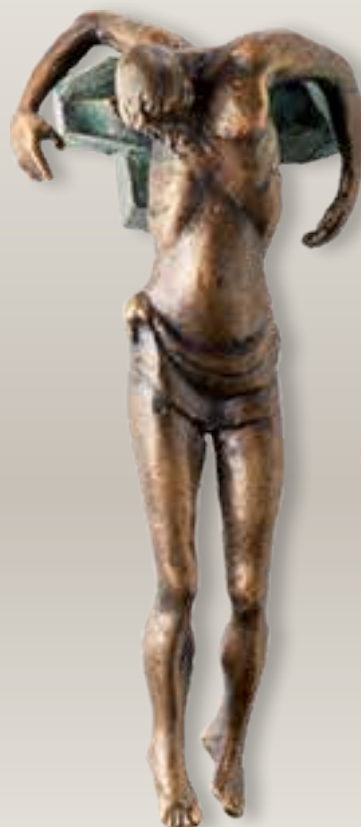

P 30 020/25
cm 25x10
Fuso a Cera Persa

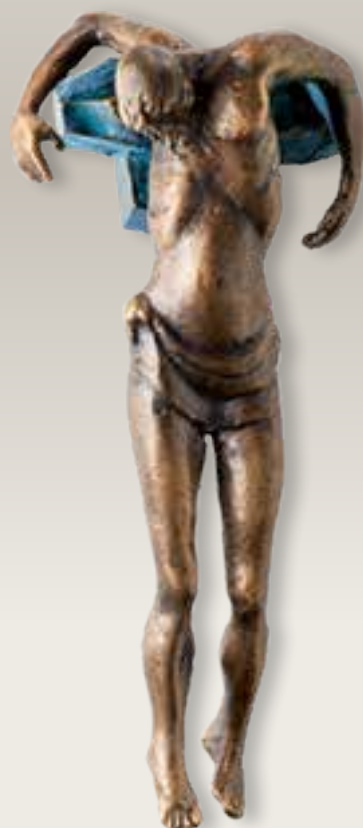

P 30 035/25
cm 25x10
Fuso a Cera Persa
Blu

crocefissi

crucifix

crucifixes

cristos

kruzifixe



CROCEFISSI



30 080/134
cm ±125x82
Fuso a cera persa

CROCEFISSI



crocefissi

crucifix

crucifixes

cristos

kruzifixe



P 30 064/90
cm 492x54



P 30 140/83
cm 483x50
(mezzo tondo)
Fuso a cera persa

crocefissi

crucifix

crucifixes

cristos

kruzifixe



CROCEFISSI



P 30 075/120
cm 120x68

CROCEFISSI



crocefissi

crucifix

crucifixes

cristos

kruzifixe

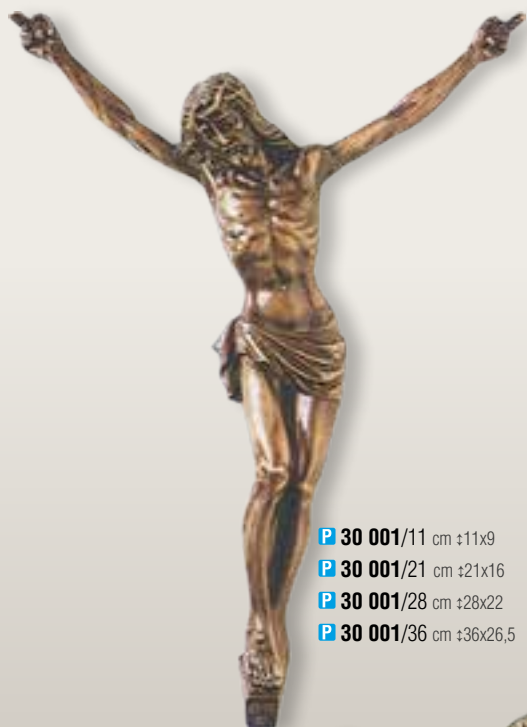

- P 30 001/11** cm ±11x9
- P 30 001/21** cm ±21x16
- P 30 001/28** cm ±28x22
- P 30 001/36** cm ±36x26,5



- P 30 001/50**
cm ±50x36,5
(mezzo tondo)



- P 30 000/60**
cm ±60x45
(mezzo tondo)



- P 30 018/10** cm ±10x3
- P 30 018/15** cm ±15x4
- P 30 018/20** cm ±20x5,5
- P 30 018/25** cm ±25x7



- P 30 000/16** cm ±16x11,5
- P 30 000/24** cm ±24x17,5
- P 30 000/27** cm ±27x19,5
- P 30 000/30** cm ±30x22

crocefissi

crucifix

crucifixes

cristos

kruzifixe



CROCEFISSI



P 30 053/09
cm +9x6,5

P 30 053/13
cm +13x10

P 30 053/17
cm +17x12

P 30 053/26
cm +26x19

P 30 053/37
cm +37x26

P 30 053/50
cm +50x38,5

P 30 053/65
cm +66x49

P 30 053/80
cm +80x61

LAMPADE
A CERO



LAMPADE A CERO



lampade
a cero

lampes
a cierges

lamps

lamparas
de vela

laternen



P 10 611/18
cm :18x14,2x12,5

T 10 622/24
cm :24x19,2x8,5



P 10 344/19
cm :19x14,2x12,5



P 10 346/19
cm :19x14,2x12,5
Decorata



P 10 160/19
cm :19x14,5x12,5

T 10 180/19
cm :19x14,5x8



P 10 200/19
cm :19x14,5x12,5

T 10 220/19
cm :19x14,5x8
Verde Pompeiano



P 10 007/20
cm :20x12,2x12

T 10 016/20
cm :20x12,2x8



P 10 023/20
cm :20x12,2x12

T 10 031/20
cm :20x12,2x8



P 10 050/20
cm :20x12,2x12

T 10 065/20
cm :20x12,2x8



P 10 121/20
cm :20x12,2x12

T 10 135/20
cm :20x12,2x8
Terra Antica



P 10 084/20
cm :20x12,2x12

T 10 101/20
cm :20x12,2x8
Verde Pompeiano



P 10 828/24
cm :26,5x13,2x14

T 10 827/24
cm :24x13,2x8x8



T 10 829/24
cm :24x13,2x8x8



P 10 565/19
cm :19x12,2x12,5

T 10 567/19
cm :19x12,2x7x7

T 10 567/24
cm :24,5x15,2x8,5x8,5



P 10 561/19
cm :19x12,2x12,5

T 10 563/19
cm :19x12,2x7x7

T 10 563/24
cm :24,5x15,2x8,5x8,5

lampade
a cero

lampes
a cierges

lamps

lamparas
de vela

laternen



LAMPADE A CERO



10 082/22
cm +22,5x12,5x8,5x8,5



10 029/23
cm +23x12,5



10 111/23
cm +23x12,5



10 005/25
cm +25x13x10x10
Evolution



10 021/25
cm +25x13x10x10
Evolution Gold



10 003/25
cm +25x14x14x14



10 051/25
cm +25x14x14x14



10 131/23
cm +23x12,5x8,5x8,5



11 010/20
cm +20x13x12,5x12,5



10 850/24
cm +23,5x13x12,5x12,5



10 110/22
cm +22x8,5x8,5x8,5



11 208/20C
cm +20x13,5x11x11

11 208/25C
cm +25,5x13,5x11x11

LAMPADE A CERO



lampade
a cero

lampes
a cierges

lamps

lamparas
de vela

laternen



P 10 307/18
cm :18x14,↔12,5

T 10 320/18
cm :18x14,↔ø7

T 10 320/24
cm :24x19,↔ø8,5
Patina chiara



P 10 303/18
cm :18x14,↔12,5

T 10 316/18
cm :18x14,↔ø7

T 10 316/24
cm :24x19,↔ø8,5
Patina scura



P 10 305/18
cm :18x14,↔12,5

T 10 318/18
cm :18x14,↔ø7

T 10 318/24
cm :24x19,↔ø8,5
Classic



P 10 912/18
cm :18x14,↔12,5

T 10 933/18
cm :18x14,↔ø7

T 10 933/24
cm :24x19,↔ø8,5



P 10 341/18
cm :18x14,↔12,5

T 10 352/18
cm :18x14,↔ø7

T 10 352/24
cm :24x19,↔ø8,5



P 10 030/20
cm :19,5x12,↔12

T 10 040/20
cm :19,5x12,↔7,5x9

T 10 040/25
cm :24,5x15,↔8x9



P 10 085/20
cm :19,5x11,↔13

T 10 090/20
cm :19,5x11,↔6,5x8,5

T 10 090/23
cm :22,5x15,↔7,5x9,5



P 10 620/19
cm :19x12,↔12

T 10 630/19
cm :19x12,↔ø6



P 10 770/19
cm :19x12,↔12



P 11 892/17
cm :17,5x12,↔11,5

T 11 904/17
cm :17,5x12,↔ø8
Con filetto dorato



P 11 892/24
cm :26x15,↔18

T 11 904/24
cm :26x15,↔ø9
Con filetto dorato



P 10 594/17
cm :17,5x12,↔11,5

T 10 606/17
cm :17,5x12,↔ø8
Con filetto bronzo



P 11 930/17
cm :17,5x12,↔11,5

T 11 932/17
cm :17,5x12,↔ø8

T 11 932/23
cm :24x15,↔ø9



P 10 424/17
cm :17x12,↔11

T 10 435/17
cm :17x12,↔ø8

lampade
a cero

lampes
a cierges

lamps

lamparas
de vela

laternen



LAMPADE A CERO



P 10 584/18
cm ±18x11,5,±11

T 10 695/18
cm ±18x11,5,±ø6,5

T 10 695/24
cm ±24x16,±ø9,5
Con filetto bronzo



P 10 581/18
cm ±18x11,5,±11

T 10 692/18
cm ±18x11,5,±ø6,5

T 10 692/24
cm ±24x16,±ø9,5
Con filetto dorato



P 10 485/18
cm ±18x11,5,±11

T 10 705/18
cm ±18x11,5,±ø6,5

T 10 705/24
cm ±24x16,±ø9,5



P 10 483/18
cm ±18x11,5,±11

T 10 702/18
cm ±18x11,5,±ø6,5

T 10 702/24
cm ±24x16,±ø9,5
Classic



P 11 334/20
cm ±20x12,±11

T 11 345/20
cm ±20x12,±ø8,5x7,5



P 11 053/18
cm ±18x14,±11



P 10 231/21
cm ±21x16,±11,5

T 10 242/21
cm ±21x16,±11x9



P 10 754/18
cm ±18x11,5,±11,5

T 10 765/18
cm ±18x11,5,±ø8



P 10 719/16
cm ±15,5x13,±12,5

T 10 721/16
cm ±15,5x13,±ø7,5

T 10 721/18
cm ±18,5x16,±ø9



P 10 402/17
cm ±16,5x11,±12



P 10 617/16
cm ±16x11,5,±10

T 10 628/16
cm ±17x11,5,±ø8



P 10 492/15
cm ±15x10,±10,5

P 10 492/19
cm ±19x12,±ø11

T 10 504/15
cm ±15x10,±ø6

T 10 504/19
cm ±19x12,±ø7,5

LAMPADE A CERO



lampade
a cero

lampes
a cierges

lamps

lamparas
de vela

laternen



11 447/24
cm :24,5x18,5,↔ø11,5



10 399/24
cm :24x16,5,↔ø8,5



10 925/23
cm :23x17,↔ø11,5



10 860/23
cm :23x12,↔9,5x9,5



10 903/24
cm :26x15,↔ø9



11 243/24
cm :24,5x15,↔ø10
Con filetto dorato



10 801/24
cm :24,5x15,↔ø10
Con filetto bronzo



10 708/29
cm :29x16,5,↔10,5x10,5



11 152/33
cm :34x16,5,↔15,5

11 163/33
cm :32x16,5,↔ø9,5



10 481/20
cm :20x12,5,↔ø9
Con cristalli



10 573/29
cm :27,5x25,↔ø9,5
Con cristalli

lampade
a cero

lampes
a cierges

lamps

lamparas
de vela

laternen



LAMPADE A CERO



P 10 080/10
cm :9,5x7,5x7



P 10 085/12
cm :11,5x9,5x8,5



P 10 070/12
cm :12x9,5x8,5



P 10 100/12
cm :12x9,5x8,5

T 10 090/12
cm :11,5x9,5xø6



P 10 014/9
cm :9x7,5x7



P 10 001/21
cm :20,5x10,5x13



P 10 116/20
cm :19,5x9,5x10,5



P 10 138/14
cm :14,5x12x12



P 10 151/18
cm :20x12,5x14



T 11 128/23
cm :22,5x12,5xø7x7



T 10 127/22
cm :21,5x9,5xø5



T 10 162/23
cm :25x12,5xø8



T 10 012/22
cm :22x10,5xø8



T 10 149/17
cm :16,5x12xø5

LAMPADE A CERO



lampade
a cero

lampes
a cierges

lamps

lamparas
de vela

laternen

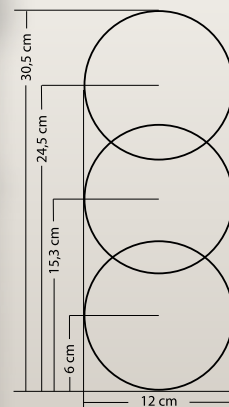

P 10 064/32
cm 32x12

P 10 064/37
cm 37x16

P 10 060/32
cm 32x12

P 10 060/37
cm 37x16



P 10 066/18
cm 18



P 10 062/18
cm 18

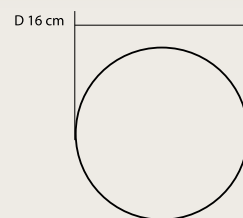

lampade
a cero

lampes
a cierges

lamps

lamparas
de vela

laternen



LAMPADE A CERO

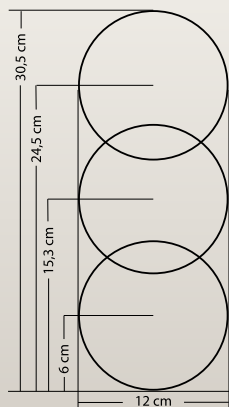

P 10 067/33
cm 33x14

LAMPADE CON PANNELLO SOLARE



lampade
a cero

lampes
a cierges

lamps

lamparas
de vela

laternen

Lampade con pannello solare

Funzionano autonomamente grazie ad un sistema composto da un pannello solare e da una batteria accumulatrice di energia. La sola luminosità del giorno è sufficiente per alimentare l'apparato. La fiamma è dotata di una luce a intermittenza.

Lampes avec panneau solaire
Autonomie de fonctionnement
grâce à un système composé d'une
panneau solaire et d'une batterie
accumulatrice d'énergie.
La seule luminosité du jour est
suffisante pour alimenter l'appareil.
La flamme est munie d'une lumière
intermittente.

Solar Lamps
These function with a self-
charging system consisting of
solar panel and battery.
Daylight is sufficient to feed
the equipment. The flame is
provided with an intermittent
light.

Lámparas solares
Funcionan autónomamente
gracias a un sistema compuesto
por un panel solar y por una
batería acumuladora de energía.
La simple luz del día es
suficiente para alimentar el
sistema. La llama está equipada
con una luz intermitente.

Tageslichtlampen
Sie funktionieren autonom dank
einea aus einem Sonnenkollektor
und einem Energieakkumulator
bestehenden System. Das
Tageslicht allein reicht zur
Versorgung des Gerätes aus. Die
Flamme ist mit einem Blinklicht
versehen.



13 611/12
cm :12,5x18,5



11 780/20
cm :19,5x13,5x11x11



11 780/25
cm :24,5x13,5x11x11



11 786/19
cm :19x12,5x7x7
11 786/24
cm :24,5x15,5x8,5x8,5



10 805/24
cm :24,5x15,5x10



10 825/24
cm :24x13,5x8x8

lampade
a cero

lampes
a cierges

lamps

lámparas
de vela

laternen



LAMPADE CON PANNELLO SOLARE

Pannello solare orientabile tramite attacco snodato

Il pannello è collegato ad una batteria accumulatrice di energia, inserita in un contenitore tubolare dotato di luce ad intermittenza ed adattabile alle lampade con fiamma $\varnothing 5$ e $\varnothing 6$ cm.

Panneau solaire orientable au moyen d'une connexion articulée.

Le panneau est relié à une batterie accumulatrice d'énergie insérée dans un récipient tubulaire pourvu de lumière à intermittance, et peut être adaptée aux lampes avec flamme de diamètre 5 et 6 cm.

Solar panel, orientable with an articulated clamp.

The panel is connected to a self charging battery which is inserted in a tubular container with intermittent light that can be adapted to lamps with flame diameter 5 and 6 cm

Panel Solar orientable mediante conexión articulada.

El panel está conectado con una abatería acumuladora de energía, insertada en un contenedor tubular dotado de luz a intermitencia y adaptable a las lámparas con llama 5 y 6 cm.

Durch Gelenkverbindung verstellbarer Solakollektor.

Der Kollektor ist an einen Energieakkumulator angeschlossen, der in einem röhrenförmigen Gehäuse angeordnet ist. Das Gehäuse ist mit einem Blinklicht versehen und kann den Lampen mit einer Flamme von $\varnothing 5$ und $\varnothing 6$ cm. angepasst werden.



95 098/15
cm 15x13,6
attacco $\varnothing 4,5$





MOTIVI
FLOREALI

MOTIVI FLOREALI

DECORATI A MANO



motivi
floreali

motifs
floraux

floral
motifs

motivos
florales

blumenmotive



P 29 210/52
cm 52,5x19
Rosso
Cera persa



P 29 300/52
cm 52,5x19
Blu
Cera persa



P 29 304/52
cm 52,5x19
Rosa
Cera persa

Ogni fiore, nelle versioni colorate, viene decorato a mano per evidenziare e rendere unico ogni soggetto, eventuali imperfezioni devono essere considerate come una garanzia dell'artigianalità del prodotto.



P 29 200/52
cm 51,5x17
Rosso
Cera persa



P 29 307/52
cm 51,5x17
Blu
Cera persa



P 29 309/52
cm 51,5x17
Rosa
Cera persa

Ogni fiore, nelle versioni colorate, viene decorato a mano per evidenziare e rendere unico ogni soggetto, eventuali imperfezioni devono essere considerate come una garanzia dell'artigianalità del prodotto.

MOTIVI FLOREALI

DECORATI A MANO



motivi
floreali

motifs
floraux

floral
motifs

motivos
florales

blumenmotive



P 29 205/35
cm 35,5x17
Rosso
Cera persa



P 29 314/35
cm 35,5x17
Blu
Cera persa



P 29 318/35
cm 35,5x17
Rosa
Cera persa

Ogni fiore, nelle versioni colorate, viene decorato a mano per evidenziare e rendere unico ogni soggetto, eventuali imperfezioni devono essere considerate come una garanzia dell'artigianalità del prodotto.

motivi
floreali

motifs
floraux

floral
motifs

motivos
florales

blumenmotive



MOTIVI FLOREALI

DECORATI A MANO



P 29 195/52
cm 50,5x22,5
Cera persa

Ogni fiore, nelle versioni colorate, viene decorato a mano per evidenziare e rendere unico ogni soggetto, eventuali imperfezioni devono essere considerate come una garanzia dell'artigianalità del prodotto.

MOTIVI FLOREALI

DECORATI A MANO



motivi
floreali

motifs
floraux

floral
motifs

motivos
florales

blumenmotive



P 29 206/50
cm 51,5x16,5
Rosa
Cera persa



P 29 320/50
cm 51,5x16,5
Azzurro
Cera persa



P 29 327/50
cm 51,5x16,5
Bianco
Cera persa

Ogni fiore, nelle versioni colorate, viene decorato a mano per evidenziare e rendere unico ogni soggetto, eventuali imperfezioni devono essere considerate come una garanzia dell'artigianalità del prodotto.

motivi
floreali

motifs
floraux

floral
motifs

motivos
florales

blumenmotive



MOTIVI FLOREALI

DECORATI A MANO



P 29 209/32
cm 32x13
Rosa
Cera persa



P 29 334/32
cm 32x13
Azzurro
Cera persa



P 29 337/32
cm 32x13
Bianco
Cera persa

Ogni fiore, nelle versioni colorate, viene decorato a mano per evidenziare e rendere unico ogni soggetto, eventuali imperfezioni devono essere considerate come una garanzia dell'artigianalità del prodotto.

MOTIVI FLOREALI

DECORATI A MANO



motivi
floreali

motifs
floraux

floral
motifs

motivos
florales

blumenmotive



29 681/53
cm +53x16,16x3
Bronzo



29 688/53
cm +53x16,16x3
Blu



29 685/53
cm +53x16,16x13
Arancione



29 683/53
cm +53x16,16x13
Rosso

Ogni fiore, nelle versioni colorate, viene decorato a mano per evidenziare e rendere unico ogni soggetto, eventuali imperfezioni devono essere considerate come una garanzia dell'artigianalità del prodotto.

motivi
floreali

motifs
floraux

floral
motifs

motivos
florales

blumenmotive



MOTIVI FLOREALI

DECORATI A MANO



T 29 690/51
cm :51x16,5x14x4
Bronzo



T 29 693/51 Rosso
cm :51x16,5x14x4
Rosso



T 29 695/51
cm :51x18,5x5x4
Bronzo



T 29 698/51
cm :51x18,5x5x4
Rosso

Ogni fiore, nelle versioni colorate, viene decorato a mano per evidenziare e rendere unico ogni soggetto, eventuali imperfezioni devono essere considerate come una garanzia dell'artigianalità del prodotto.

MOTIVI FLOREALI

DECORATI A MANO



motivi
floreali

motifs
floraux

floral
motifs

motivos
florales

blumenmotive



P 29 751/28
cm ±28x8,5
Bronzo



P 29 753/28
cm ±28x8,5
Rosso



P 29 757/28
cm ±28x8,5
Blu



P 29 755/28
cm ±28x8,5
Arancione

Ogni fiore, nelle versioni colorate, viene decorato a mano per evidenziare e rendere unico ogni soggetto, eventuali imperfezioni devono essere considerate come una garanzia dell'artigianalità del prodotto.

motivi
floreali

motifs
floraux

floral
motifs

motivos
florales

blumenmotive



MOTIVI FLOREALI

DECORATI A MANO



P 29 811/28
cm +28x9
Bronzo



P 29 818/28
cm +28x9
Rosso



P 29 715/25
cm +25x9
Bronzo



P 29 720/25
cm +25x9
Rosso

Ogni fiore, nelle versioni colorate, viene decorato a mano per evidenziare e rendere unico ogni soggetto, eventuali imperfezioni devono essere considerate come una garanzia dell'artigianalità del prodotto.

MOTIVI FLOREALI

DECORATI A MANO



motivi
floreali

motifs
floraux

floral
motifs

motivos
florales

blumenmotive



P 29 834/16
cm ±16,5x6
Bronzo



P 29 836/16
cm ±16,5x6
Bianco



P 29 830/16
cm ±16,5x6
Blu



P 29 832/16
cm ±16,5x6
Rosso



P 29 784/16
cm ±16x4
Bronzo



P 29 782/16
cm ±16x4
Bianco



P 29 786/16
cm ±16x4
Giallo



P 29 780/16
cm ±16x4
Rosa

Ogni fiore, nelle versioni colorate, viene decorato a mano per evidenziare e rendere unico ogni soggetto, eventuali imperfezioni devono essere considerate come una garanzia dell'artigianalità del prodotto.

motivi
floreali

motifs
floraux

floral
motifs

motivos
florales

blumenmotive



MOTIVI FLOREALI

DECORATI A MANO



P 29 854/15
cm ±15,5x8
Bronzo



P 29 856/15
cm ±15,5x8
Bianco



P 29 850/15
cm ±15,5x8
Arancione



P 29 852/15
cm ±15,5x8
Rosa



P 29 754/30
cm ±30x10
Bronzo



P 29 752/30
cm ±30x10
Bianco



P 29 750/30
cm ±30x10
Blu



P 29 756/30
cm ±30x10
Rosa



P 29 758/30
cm ±30x10
Rosso

Ogni fiore, nelle versioni colorate, viene decorato a mano per evidenziare e rendere unico ogni soggetto, eventuali imperfezioni devono essere considerate come una garanzia dell'artigianalità del prodotto.

MOTIVI FLOREALI

DECORATI A MANO



motivi
floreali

motifs
floraux

floral
motifs

motivos
florales

blumenmotive



P 29 764/15
cm ±15,5x8
Bronzo



P 29 760/15
cm ±15,5x8
Azzurro



P 29 762/15
cm ±15,5x8
Bianco



P 29 766/15
cm ±15,5x8
Arancione

Ogni fiore, nelle versioni colorate, viene decorato a mano per evidenziare e rendere unico ogni soggetto, eventuali imperfezioni devono essere considerate come una garanzia dell'artigianalità del prodotto.





motivi
floreali

motifs
floraux

floral
motifs

motivos
florales

blumenmotive



P 29 120/34
cm ±34x14
Fuso a cera persa



P 29 080/34
cm ±34x14
Fuso a cera persa



P 29 119/17
cm ±17x11
Fuso a cera persa



P 29 060/17
cm ±17x11
Fuso a cera persa



P 29 130/19
cm ±19x19
Fuso a cera persa



P 29 100/19
cm ±19x19
Fuso a cera persa



P 29 079/19
cm ±19x9
Fuso a cera persa



P 29 117/10
cm ±9x4,5
Fuso a cera persa



P 29 106/15
cm ±13x7
Fuso a cera persa



P 29 037/07
cm ±17,2±21,5±5,5
Fuso a cera persa



P 29 180/08
cm ±8x8±5x5



P 29 146/08
cm ±8x8±5x5



P 29 098/04
cm ±4,5x3



P 29 069/04
cm ±4,5x3



P 29 116/06
cm ±6x3,5



P 29 105/06
cm ±6x3,5



P 29 142/08
cm ±8x4,8



P 29 121/08
cm ±8x4,8

Esempio di applicazione





P 29 109/12
cm :12x13,2x6,5
Fuso a cera persa



P 29 093/54
cm :54x12,2x3

T 29 103/54
cm :54x12,2x3
Fuso a Cera Persa



P 29 118/15
cm :15x10,2x4,5
Fuso a cera persa

motivi
floreali

motifs
floraux

floral
motifs

motivos
florales

blumenmotive



MOTIVI FLOREALI



P 29 235/40
cm ±40x19



P 29 235/30
cm ±30x15



P 29 220/30
cm ±30x15



P 29 220/40
cm ±40x19



P 29 239/40
cm ±40x19



P 29 239/30
cm ±30x15



P 29 229/30
cm ±30x15



P 29 229/40
cm ±40x19



P 29 140/40
cm ±40x19



P 29 140/30
cm ±30x15



P 29 150/30
cm ±30x15



P 29 150/40
cm ±40x19





Le ROSE
decorate a mano
in pressofusione

MOTIVI FLOREALI

DECORATI A MANO



motivi
floreali

motifs
floraux

floral
motifs

motivos
florales

blumenmotive



P 29 310/14
cm 14x9

Rosso



P 29 310/18
cm 18x10

Rosso



P 29 310/22
cm 22x11

Rosso



P 29 310/27
cm 27x13

Rosso

P 29 310/30
cm 30x14

Rosso

P 29 310/39
cm 39x18

Rosso

P 29 310/44
cm 44x18

Rosso

Ogni fiore, nelle versioni colorate, viene decorato a mano per evidenziare e rendere unico ogni soggetto, eventuali imperfezioni devono essere considerate come una garanzia dell'artigianalità del prodotto.

motivi
floreali

motifs
floraux

floral
motifs

motivos
florales

blumenmotive



MOTIVI FLOREALI

DECORATI A MANO



P 29 315/14
cm 14x9

Rosso



P 29 315/18
cm 18x10

Rosso



P 29 315/22
cm 22x11

Rosso



P 29 315/27
cm 27x13

Rosso



P 29 315/30
cm 30x14

Rosso



P 29 315/39
cm 39x18

Rosso



P 29 315/44
cm 44x18

Rosso

Ogni fiore, nelle versioni colorate, viene decorato a mano per evidenziare e rendere unico ogni soggetto, eventuali imperfezioni devono essere considerate come una garanzia dell'artigianalità del prodotto.

MOTIVI FLOREALI

DECORATI A MANO



motivi
floreali

motifs
floraux

floral
motifs

motivos
florales

blumenmotive



P 29 134/14
cm 14x9

Blu



P 29 134/18
cm 18x10

Blu



P 29 134/22
cm 22x11

Blu



P 29 134/27
cm 27x13

Blu

P 29 134/30
cm 30x14

Blu

P 29 134/39
cm 39x18

Blu

P 29 134/44
cm 44x18

Blu

Ogni fiore, nelle versioni colorate, viene decorato a mano per evidenziare e rendere unico ogni soggetto, eventuali imperfezioni devono essere considerate come una garanzia dell'artigianalità del prodotto.

motivi
floreali

motifs
floraux

floral
motifs

motivos
florales

blumenmotive



MOTIVI FLOREALI

DECORATI A MANO



P 29 305/14
cm 14x9

Blu



P 29 305/18
cm 18x10

Blu



P 29 305/22
cm 22x11

Blu



P 29 305/27
cm 27x13

Blu



P 29 305/30
cm 30x14

Blu



P 29 305/39
cm 39x18

Blu



P 29 305/44
cm 44x18

Blu

Ogni fiore, nelle versioni colorate, viene decorato a mano per evidenziare e rendere unico ogni soggetto, eventuali imperfezioni devono essere considerate come una garanzia dell'artigianalità del prodotto.

MOTIVI FLOREALI

DECORATI A MANO



motivi
floreali

motifs
floraux

floral
motifs

motivos
florales

blumenmotive



P 29 138/14
cm 14x9

Rosa



P 29 138/18
cm 18x10

Rosa



P 29 138/22
cm 22x11

Rosa



P 29 138/27
cm 27x13

Rosa

P 29 138/30
cm 30x14

Rosa

P 29 138/39
cm 39x18

Rosa

P 29 138/44
cm 44x18

Rosa

Ogni fiore, nelle versioni colorate, viene decorato a mano per evidenziare e rendere unico ogni soggetto, eventuali imperfezioni devono essere considerate come una garanzia dell'artigianalità del prodotto.

motivi
floreali

motifs
floraux

floral
motifs

motivos
florales

blumenmotive



MOTIVI FLOREALI

DECORATI A MANO



P 29 321/14
cm 14x9

Rosa



P 29 321/18
cm 18x10

Rosa



P 29 321/22
cm 22x11

Rosa



P 29 321/27
cm 27x13

Rosa



P 29 321/30
cm 30x14

Rosa



P 29 321/39
cm 39x18

Rosa



P 29 321/44
cm 44x18

Rosa

Ogni fiore, nelle versioni colorate, viene decorato a mano per evidenziare e rendere unico ogni soggetto, eventuali imperfezioni devono essere considerate come una garanzia dell'artigianalità del prodotto.

MOTIVI FLOREALI



motivi
floreali

motifs
floraux

floral
motifs

motivos
florales

blumenmotive



P 29 632/21
cm ±21x12

P 29 632/31
cm ±31x16

P 29 632/35
cm ±35x15

P 29 632/42
cm ±42x17

P 29 632/45
cm ±45x18

P 29 632/52
cm ±52x18

P 29 632/56
cm ±56x18



P 29 621/21
cm ±21x12

P 29 621/31
cm ±31x16

P 29 621/35
cm ±35x16

P 29 621/43
cm ±43x18

P 29 621/46
cm ±46x18

P 29 621/53
cm ±53x18

P 29 621/56
cm ±56x18

motivi
floreali

motifs
floraux

floral
motifs

motivos
florales

blumenmotive



MOTIVI FLOREALI



P 29 619/21
cm ±21x12



P 29 619/32
cm ±32x17



P 29 619/36
cm ±36x17



P 29 619/43
cm ±43x17



P 29 619/48
cm ±48x17



P 29 619/60
cm ±60x18



P 29 634/50
cm ±52x40



P 29 636/50
cm ±52x40

MOTIVI FLOREALI



motivi
floreali

motifs
floraux

floral
motifs

motivos
florales

blumenmotive



P 29 676/21
cm ±21x12

P 29 676/31
cm ±31x16

P 29 676/35
cm ±35x15

P 29 676/42
cm ±42x17

P 29 676/45
cm ±45x18

P 29 676/52
cm ±52x18

P 29 676/56
cm ±56x18



P 29 655/21
cm ±21x12

P 29 665/31
cm ±31x16

P 29 665/35
cm ±35x16

P 29 665/43
cm ±43x18

P 29 665/46
cm ±46x18

P 29 665/53
cm ±53x18

P 29 665/56
cm ±56x18

motivi
floreali

motifs
floraux

floral
motifs

motivos
florales

blumenmotive



MOTIVI FLOREALI



P 29 654/21
cm ±21x12



P 29 654/32
cm ±32x17



P 29 654/36
cm ±36x17



P 29 654/43
cm ±43x17



P 29 654/48
cm ±48x17



P 29 654/60
cm ±60x18



P 29 678/50
cm ±52x40



P 29 680/50
cm ±52x40

MOTIVI FLOREALI



motivi
floreali

motifs
floraux

floral
motifs

motivos
florales

blumenmotive



P 29 016/21
cm +21x12

P 29 016/31
cm +31x16

P 29 016/35
cm +35x15

P 29 016/42
cm +42x17

P 29 016/45
cm +45x18

P 29 016/52
cm +52x18

P 29 016/56
cm +56x18



P 29 027/21
cm +21x12

P 29 027/31
cm +31x16

P 29 027/35
cm +35x16

P 29 027/43
cm +43x18

P 29 027/46
cm +46x18

P 29 027/53
cm +53x18

P 29 027/56
cm +56x18

motivi
floreali

motifs
floraux

floral
motifs

motivos
florales

blumenmotive



MOTIVI FLOREALI



P 29 038/21
cm ±21x12



P 29 038/32
cm ±32x17



P 29 038/36
cm ±36x17



P 29 038/43
cm ±43x17



P 29 038/48
cm ±48x17



P 29 038/60
cm ±60x18



P 29 049/50
cm ±52x40



P 29 051/50
cm ±52x40

MOTIVI FLOREALI



motivi
floreali

motifs
floraux

floral
motifs

motivos
florales

blumenmotive



P 29 351/14
cm ±14x9

P 29 351/18
cm ±18x10

P 29 351/22
cm ±22x11

P 29 351/27
cm ±27x13

P 29 351/30
cm ±30x14

P 29 351/39
cm ±39x18

P 29 351/44
cm ±44x18



P 29 369/14
cm ±14x9

P 29 369/18
cm ±18x10

P 29 369/22
cm ±22x11

P 29 369/27
cm ±27x13

P 29 369/30
cm ±30x14

P 29 369/39
cm ±39x18

P 29 369/44
cm ±44x18

motivi
floreali

motifs
floraux

floral
motifs

motivos
florales

blumenmotive



MOTIVI FLOREALI



P 29 346/15
cm ±15x8

P 29 346/19
cm ±19x12,5

P 29 346/23
cm ±23x11

P 29 346/28
cm ±28x13

P 29 346/31
cm ±31x14

P 29 346/40
cm ±40x15

P 29 346/45
cm ±45x16



P 29 323/28
cm ±28x24

P 29 335/28
cm ±28x24

P 29 301/45
cm ±45x35

P 29 312/45
cm ±45x35

MOTIVI FLOREALI



motivi
floreali

motifs
floraux

floral
motifs

motivos
florales

blumenmotive



P 29 084/28
cm ±28x11



P 29 084/39
cm ±39x10



P 29 084/43
cm ±43x15



P 29 084/48
cm ±48x17



P 29 062/44
cm ±44x29



P 29 073/44
cm ±44x29



MOTIVI FLOREALI



P 29 110/38
cm :38x18



P 29 112/35
cm :35x16



P 29 233/47
cm :47x17,28



P 29 211/25
cm :25x11,26,5



I 20 110/09
cm :25x29,24,28
Cornice cm 9x12
Fiamma ø cm 6

I 20 110/11
cm :28x29,24,28
Cornice cm 11x15
Fiamma ø cm 6
Questa composizione
si fornisce solo con
cornice ovale **19 101**



I 20 122/09
cm :25x29,24,28
Cornice cm 9x12
Fiamma ø cm 6

I 20 122/11
cm :28x29,24,28
Cornice cm 11x15
Fiamma ø cm 6
Questa composizione
si fornisce solo con
cornice rettangolare **21 081**



I 20 143/15
cm :15x28,23,28
Fiamma ø cm 6



I 20 131/15
cm :15x26,23,28x7
con fiamma cristallo **98 117/0**

I 20 206/0
cm :13x26,23,28x7
senza fiamma ø cm 5

I 20 117/15
cm :15x26,23,28x7
con fiamma tradizionale
in vetro **98 055**

MOTIVI FLOREALI



motivi
floreali

motifs
floraux

floral
motifs

motivos
florales

blumenmotive



Rosa

P 29 270/18
cm ±18x6



Rosa

P 29 350/16
cm ±16x11,5



Rosa

P 29 259/13
cm ±13,5x8



Rosa

P 29 132/14
cm ±14x7



Rosa

P 29 124/14
cm ±14x8



Rosa

P 29 280/18
cm ±18x6



Rosa

P 29 290/16
cm ±16x11,5



Rosa

P 29 260/13
cm ±13,5x8



Tulipano

P 29 539/24
cm ±24x5



Irisco

P 29 459/25
cm ±25,5x6



P 29 012/39
cm ±39x15



P 29 010/34
cm ±34x15,5



Edera

P 29 596/23
cm ±23x7



Tralcio d'uva

P 29 472/22
cm ±22x6

motivi
floreali

motifs
floraux

floral
motifs

motivos
florales

blumenmotive



MOTIVI FLOREALI

NEW



Mani con Rosa

P 31 085/13
cm ±13x8,5



Rosa

P 29 563/16
cm ±16x5



Rosa

P 29 541/21
cm ±21x5,5



Rosa

P 29 574/27
cm ±27,5x9



Rosa

P 29 552/29
cm ±29,5x8



Rosa

P 29 561/29
cm ±29,5x8



Violette

P 29 483/16
cm ±16x7



Giglio

P 29 404/23
cm ±23x5,5



Stelle Alpine

P 29 415/20
cm ±20x5



Viole del pensiero

P 29 448/21
cm ±21x6,5



Spiga

P 29 585/22
cm ±22x6



Fiore di pesco

P 29 144/22
cm ±22x9



Fiore di pesco

P 29 506/25
cm ±25x7



Fiore di pesco

P 29 517/26
cm ±26x8,5



Fiore di pesco

P 29 528/26
cm ±26x7

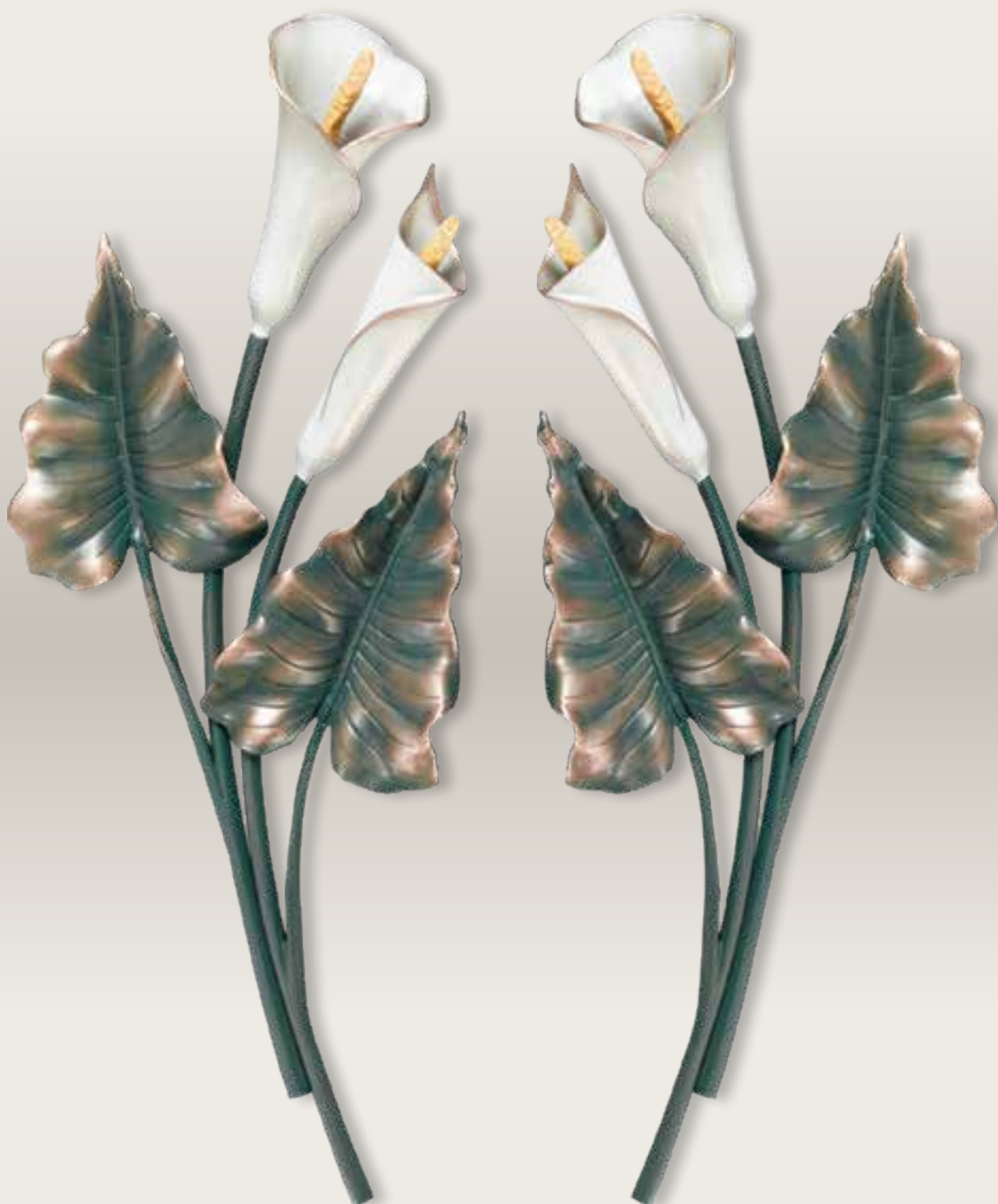

P 29 026/51
cm #51x20,~10
Fuso a cera persa

P 29 030/51
cm #51x20,~10
Fuso a cera persa



Calla doppia dx

P 29 056/42
cm ±42x14,±2,5



Calla dx

P 29 058/27
cm ±27x11,5,±2,5



P 29 092/10

cm ±10x3
Fuso a cera persa



Calla sx

P 29 057/27
cm ±27x11,5,±2,5



Calla doppia sx

P 29 055/42
cm ±42x14,±2,5



P 29 026/40
cm ±40x15,±6
Fuso a cera persa



P 29 030/40
cm ±40x15,±6
Fuso a cera persa



Gigli

P 29 044/40
cm ±40x15,±10
Fuso a cera persa



Gigli

P 29 044/30
cm ±30x13,±10
Fuso a cera persa



P 29 020/51
cm :51x20,~10
Fuso a cera persa

P 29 029/51
cm :51x20,~10
Fuso a cera persa



P 29 020/40
cm ±40x15,±6
Fuso a cera persa



P 29 029/40
cm ±40x15,±6
Fuso a cera persa



Calla doppia dx
P 29 024/42
cm ±42x14,±2,5



Calla dx
P 29 035/27
cm ±27x11,5,±2,5



P 29 083/10
cm ±10x3
Fuso a cera persa



Calla sx
P 29 033/27
cm ±27x11,5,±2,5



Calla doppia sx
P 29 022/42
cm ±42x14,±2,5

MOTIVI FLOREALI



motivi
floreali

motifs
floraux

floral
motifs

motivos
florales

blumenmotive



P 29 122/50
cm :48x35



P 29 081/40
cm :42x20



P 29 061/34
cm :34x23



P 29 115/85
cm :85x45



P 29 068/42
cm :49x40



P 29 059/46
cm :48x40

Il prezzo delle composizioni non comprende i "Fiori di Luce".

motivi
floreali

motifs
floraux

floral
motifs

motivos
florales

blumenmotive



MOTIVI FLOREALI



P 29 040/08
cm ±8x8



P 29 128/17
cm ±17x17



P 29 078/16
cm ±20x16



P 29 108/25
cm ±23x19



P 29 101/25
cm ±22x20



P 29 090/32
cm ±32x24



P 29 094/26
cm ±26x17



P 29 045/16
cm ±16x43

FIORI DI LUCE

cristalli

embouts

ring

lamparas

kränze



95 088/0
cm ±ø9
con led bianco



95 034/0
cm ±ø9
con led bianco



95 125/0
cm ±ø8,5
con led bianco



95 113/0
cm ±ø7,8
con led bianco



95 067/0
cm ↔6,8
con led bianco



95 123/0
cm ±8
con led bianco

95 099/0
cm ±ø9
con led blu

95 066/0
cm ±ø9
con led blu

95 145/0
cm ±ø8,5
con led blu

95 118/0
cm ±ø7,8
con led blu

95 082/0
cm ↔6,8
con led blu

95 140/0
cm ±8
con led blu

Tutte le opere sono state realizzate secondo l'antica tecnica del mosaico bizantino-romano. Le tessere sono in oro, smalti in pasta di vetro, marmi e pietre, e vengono rigorosamente tagliate a mano, con martellina e tagliolo.

MOSAICI





LIMPIDO INCANTO

P 34 230/51

cm :51x18

Applicazione a incasso

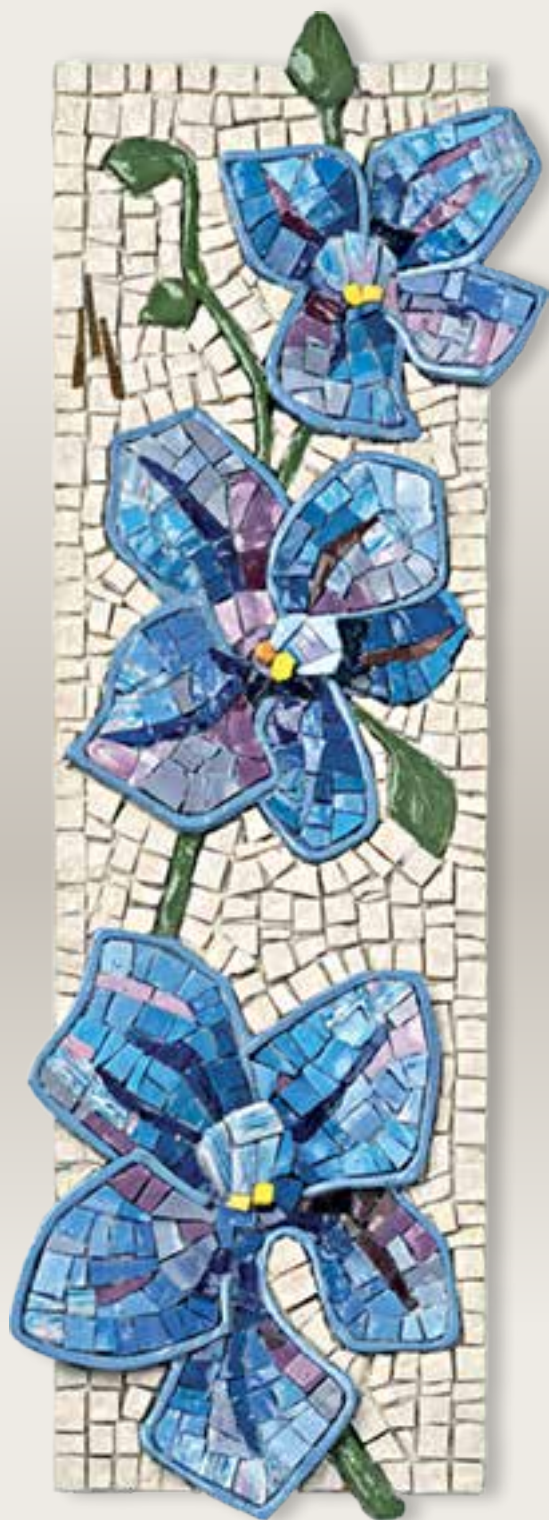

ETEREO PROFUMO

P 34 310/45
cm ±45x16
Applicazione a incasso



FLUTTUANTI EMOZIONI

P 34 290/46
cm ±45,5x16,5
Applicazione a incasso



LIEVE ESSENZA

P 34 330/45

cm ±45x18

Applicazione a incasso



ETERNO AMORE

P 34 350/45

cm ±45x18

Applicazione a incasso



LUCE AL MATTINO

P 34 340/45
cm ±45x18
Applicazione a incasso



BIANCO CANDORE

P 34 320/45
cm ±45x18
Applicazione a incasso



RILUCENTI EMOZIONI

P 34 300/48
cm :47,5x18
Applicazione a incasso



SORGENTE DI VITA

P 34 220/53
cm :53x14
Applicazione a incasso



TENERO FIORE

P 34 240/52
cm #52x19
Applicazione a incasso



SIMBOLO D'AMORE

P 34 250/52
cm #52x19
Applicazione a incasso



ENERGIA LUMINOSA

P 34 270/41

cm ±41x20

Applicazione con perni



ABBRACCIO AMOREVOLE

P 34 200/37

cm ±37x23

Applicazione a incasso

TARGHE





Madonna mani giunte

P 32 674/14
cm ±14x8

P 32 674/20
cm ±20x12



Madonna

P 31 075/10
cm ±10x8,±3,5

P 31 075/18
cm ±18x14,±6

P 31 075/28
cm ±28x22,±7,5



Madonna

P 31 191/14
cm ±14x8

P 31 191/20
cm ±20x11



Madonna

P 31 076/18
cm ±18x11,5



Madonna

P 32 671/10
cm ±10x6,5



Madonna

P 31 247/18
cm ±18x13

P 31 247/30
cm ±30,5x19,5



Madonna

P 31 019/12
cm ±12x8,5

P 31 019/17
cm ±17x12

P 31 019/24
cm ±24x17,5



Madonna

P 32 589/106
cm ±11x8



Madonna

P 31 043/14
cm ±14x11,5

P 31 043/20
cm ±20x16,5



Madonna

P 31 178/15
cm ±15x8,5



Madonna

P 31 668/13
cm ±13x10

P 31 668/18
cm ±18x13

P 31 668/26
cm ±26x19,5



Madonna

P 31 661/13
cm ±13x10

P 31 661/18
cm ±18x13
Finitura Classic

TARGHE



targhe

appliques

plaques

figuras

schilder



Madonna

P 31 830/23
cm :23x18
Fuso a cera persa



Madonna

P 32 944/34
cm :34x28
Fuso a cera persa



Madonna

P 32 773/35
cm :35x25
Con filetto dorato



Madonna

P 32 875/35
cm :35x25



Madonna

P 32 933/39
cm :39x29
Fuso a cera persa



Madonna

P 32 988/42
cm :42x35,5x18



P 31 160/33

cm :33x24
Fuso a cera persa



Madonna

P 31 041/14
cm ±14x11,5

P 31 041/16
cm ±16x13

P 31 041/20
cm ±20x16



Madonna

P 32 818/20
cm ±20x15

P 32 818/30
cm ±30,5x20



Madonna

P 31 362/24
cm ±24x20



Madonna del roseto

P 31 017/16
cm ±16x13

P 31 017/20
cm ±20x16,5

P 31 017/31
cm ±31x25



Madonna del roseto

P 31 028/34
cm ±34x25



Madonna del roseto

P 31 115/16
cm ±16x13

P 31 115/20
cm ±20x16,5

P 31 115/31
cm ±31x25



Madonna del roseto

P 31 126/34
cm ±34x25



Madonna

P 31 098/23
cm ±23x9



Madonna

P 32 693/20
cm ±20x11



Madonna del Lippi

P 32 077/29
cm ±29x20



Madonna

P 31 065/23
cm ±23x13

TARGHE



targhe

appliques

plaques

figuras

schilder



Madonna con Bambino

- P 32 010/09** cm ±9x6
- P 32 010/13** cm ±13x8
- P 32 010/26** cm ±26x16,5
- P 32 010/47** cm ±47x30



Madonna con Bambino

- P 32 682/18** cm ±18x13



Madonna con Bambino

- P 31 305/44** cm ±44x18



Madonna con Bambino

- P 31 373/37** cm ±36x16



Madonna con Bambino

- P 31 418/40** cm ±40x11
- P 31 418/50** cm ±50x14



Madonna del Carmine

- P 32 716/35** cm ±35x15,7



Madonna con Bambino

- P 31 429/40** cm ±40x11



Madonna del Carmine sul trono

- P 32 738/22** cm ±22,5x13,4
- P 32 738/32** cm ±32,5x18,5,7



Madonna

P 33 012/56 cm ±56x14



Madonna

P 32 102/41 cm ±41x11,5



Madonna

P 31 156/26 cm ±26,5x9,5



Madonna

P 31 338/50 cm ±51x16



Madonna

P 31 293/49 cm ±49x14



Cristo

P 31 032/14
cm ±14x11

P 31 032/20
cm ±20x16



Cristo

P 31 180/10
cm ±10x8,3,5

P 31 180/18
cm ±18x14,6

P 31 180/28
cm ±28x22,5,9



Cristo

P 31 021/12
cm ±12x8,5

P 31 021/17
cm ±17x12

P 31 021/25
cm ±25x17



Cristo

P 32 578/105
cm ±11x8,5



Cristo

P 31 679/13
cm ±13x9

P 31 679/18
cm ±18x12,5

P 31 679/26
cm ±26x18,5



Cristo

P 31 672/13
cm ±13x9

P 31 672/18
cm ±18x12,5
Finitura Classic



Cristo

P 31 225/20
cm ±20x13



Cristo

P 31 258/27
cm ±27x16



Cristo

P 32 044/24
cm ±24x21,5



Cristo

P 31 203/14
cm :14x9

P 31 203/20
cm :20x12,5



Cristo

P 31 236/26
cm :26x17,5



Cristo

P 31 030/14
cm :14x12,5

P 31 030/16
cm :16x14

P 31 030/20
cm :20x18



Cristo

P 33 023/28
cm :28x23,5



Cristo

P 32 669/10
cm :10x6,5



Cristo

P 31 123/20
cm :20x19



Cristo

P 32 977/40
cm :40x35,5x19



Cristo

P 31 490/37
cm :37x33



Cristo

P 32 055/30
cm :30x26



Cristo

P 32 922/34
cm :34x28
Fuso a cera persa



Cristo

P 32 829/20
cm :20x15
P 32 829/30
cm :30x19



Cristo incoronato

P 31 014/16
cm :16x13
P 31 014/20
cm :20x16,5
P 31 014/30
cm :30x24



Cristo

P 32 911/39
cm :39x29
Fuso a cera persa



Cristo

P 32 795/35
cm :35x25
Con filetto dorato



Cristo

P 32 886/35
cm :35x25



Cristo incoronato

P 31 025/34
cm :34x24,5



Cristo

P 31 570/50
cm :50x47x12
Fuso a cera persa



Cristo

P 31 320/47
cm :47x54x16
Fuso a cera persa



Cristo

P 31 511/40
cm :40x31



Sacro Cuore

P 31 189/15
cm +15,5x10



Sacro Cuore

P 31 112/12
cm +12x11

P 31 112/27
cm +27x25



Sacro Cuore

P 31 210/29
cm +29x24,5



Cristo Nazareno

P 33 045/35
cm +35x23,7x8



Cristo Nazareno

P 33 045/43
cm +43x23,7x8



Cristo

P 32 099/54
cm +54x26



Sacro Cuore

P 31 167/26
cm +26x10



Sacro Cuore

P 33 147/38
cm +37,5x17,7



Pietà

P 31 464/39
cm :39x29,5



Pietà

P 32 831/36
cm :36x24,5

P 32 831/46
cm :46x31,5

P 32 831/53
cm :53x36



Pietà

P 32 995/51
cm :51x39
Fuso a cera persa



Pietà

P 31 475/40
cm :40x31



Pietà

P 32 897/38
cm :38x28

P 32 897/49
cm :49x33

P 32 897/57
cm :57x39



Pietà

P 31 522/52
cm :52x37



Pietà

P 32 955/55
cm :55x40
Fuso a cera persa



Pietà

P 31 407/32
cm :32,5x18,5



Pietà

P 31 384/26
cm :26x17,5



Pietà

P 31 395/46
cm :45,5x23



Pietà

P 32 283/42
cm :42x30



Pietà

P 32 250/52
cm :52x30
Fuso a cera persa



Pietà

P 31 190/10
cm ±10x10,±3,5

P 31 190/18
cm ±18x18,±5,5

P 31 190/30
cm ±30x30,±9



Pietà

P 32 185/26
cm ±26x21,5



Pietà

P 31 052/14
cm ±14x12,5

P 31 052/16
cm ±16x13

P 31 052/21
cm ±21x18



Pietà

P 31 681/14
cm ±14x12,5

P 31 681/18
cm ±18x16,5

P 31 681/26
cm ±26x24



Pietà

P 31 688/14
cm ±14x12,5

P 31 688/18
cm ±18x16,5
Finitura Classic



Pietà

P 31 349/41
cm ±41x18,5



Pietà

P 31 101/18
cm ±18x13

P 31 101/26
cm ±26x19



Pietà

P 32 128/38
cm ±38x30



Pietà

P 32 131/43
cm ±43x38



Battesimo

P 32 107/42
cm ±42x39



Pietà

P 31 282/49
cm ±49x14,5



Pietà

P 31 327/50
cm ±51x16



Pietà

- P 31 533/19**
cm ±19x16,5,±4
- P 31 533/26**
cm ±26x22,±5



Pietà

- P 35 355/19**
cm ±19x16,5,±8
- P 35 355/26**
cm ±26x23,±10,5
- T 35 366/19**
cm ±19,±16,5x8
- T 35 366/26**
cm ±26,±23x10,5



Pietà (altorilievo)

- P 32 990/42**
cm ±42x29,±12



Pietà

- P 32 317/40**
cm ±39x35,±4



Pietà

- P 32 317/56**
cm ±54x45,±3,5



Pietà

P 32 180/45
cm +45x54,2x13
Fuso a cera persa



Pietà

P 31 790/49
cm +49x53,2x14
Fuso a cera persa



Crocifissione

P 31 504/50
cm +50x38,2x15
Fuso a cera persa



Pietà

P 32 328/60
cm +60x55



Madonna con Bambino

P 33 231/60
cm +60x48,2x8
Fuso a cera persa



Crocifissione

P 33 171/93
cm +90x69
Fuso a cera persa



Deposizione

P 31 655/29
cm +29x67,2x8
Fuso a cera persa



Deposizione

P 31 680/36
cm +36,5x52,5x11
Fuso a cera persa



Ascensione

P 33 178/104

cm ±104x72

Fuso a cera persa



Ultima Cena

P 33 025/107
 cm :107x211,1x12
 Fuso a cera persa



Ultima Cena

P 32 419/20
 cm :20x87



Ultima Cena

P 32 540/34
 cm :34x74
 Fuso a cera persa

TARGHE

TESTATE PER MONUMENTO



targhe appliques plaques figuras schilder



Amicizia

P 32 421/31
cm ±31x47



Donazione

P 33 136/48
cm ±48x46,5
Fuso a cera persa



Mani giunte

P 32 603/21
cm ±21x10

P 32 603/31
cm ±31,5x19,5



Sacra Famiglia

P 32 592/53
cm ± ø 53,11
Fuso a cera persa



Sacra Famiglia

I 32 594/66
cm ±66x53,31x5
Fuso a cera persa

targhe

appliques

plaques

figuras

schilder



TARGHE

TESTATE PER MONUMENTO



Redentore

P 32 470/35

cm 435x37

Fuso a cera persa



P 31 839/20
cm 420,5x20,5
(componibile)



P 33 615/34
cm 434x79,4x8
Con colomba dorata



P 31 828/20
cm 420,5x20,5
(componibile)
Con colomba dorata

TARGHE



targhe

appliques

plaques

figuras

schilder



Angelo

P 31 040/17
cm ±17x11



Angelo

P 31 050/17
cm ±17x11



Angelo

P 31 646/20
cm ±20x11

P 31 646/25
cm ±25x14



Angelo

P 31 657/20
cm ±20x11

P 31 657/25
cm ±25x14



Angioletto SX

P 31 650/13
cm ±13,5x16



Angioletto DX

P 31 645/13
cm ±13,5x16



Angioletto

P 32 001/05
cm ±5x8

P 32 001/10
cm ±10,5x16,5



S. Antonio

P 32 226/20
cm :20x14,6



S. Antonio

P 32 173/29
cm :29x19



S. Giuseppe

P 31 223/30
cm :30x25



San Pio

P 31 001/38
cm :38x14



San Pio

P 31 003/21
cm :21x14



San Pio

P 31 005/14
cm :14x10



San Pio

P 32 541/24
cm :24x16,5



San Pio

P 32 100/30
cm ø30



S. Antonio

P 32 226/37
cm :37x14,6



S. Giuseppe

P 32 215/38
cm :38x14,6



Papa Giovanni Paolo II

P 33 027/20
cm :20x13,5

P 33 027/59
cm :59x39



Papa Giovanni XXIII

P 32 730/12
cm :12x9,5



Volo Colombe

33 444/102
cm ±100x53,5 ±13x23



Albero con Colombe

33 934/0
cm ±74x47 ±22x13



Volo Colombe

33 386/44
cm ±44x37 ±22x27



Volo Colombe

33 604/34
cm ±34x48 ±11x21



Volo Colombe

33 581/30
cm ±30x36 ±14,5x8



Volo Colombe

33 568/23
cm ±23x31 ±8x14,5



33 546/12
cm ±12x30 ±20



33 502/8
cm ±8x31 ±20



33 524/16
cm ±16x23 ±20



T 33 402/0
cm ±5,5x3,5±8



T 33 404/0
cm ±4x3,5±8



T 33 410/0
cm ±4x4±6



T 33 412/0
cm ±4x4±6



T 33 415/0
cm ±4x7±7



T 33 403/0
cm ±3x3,5±9



T 33 401/0
cm ±5x4±8



P 29 003/06
cm ±6x6,5



P 29 046/04
cm ±4x4



P 29 066/04
cm ±4x4



P 29 071/04
cm ±4x4
Lucidata



P 29 009/05
cm ±5x4,5



T 29 097/06
cm ±6x6



T 29 104/05
cm ±7x5



T 29 102/08
cm ±4x8



T 29 099/09
cm ±4,5x9,5



P 33 260/17
cm +17x25,9

I 33 265/15
cm +15,24x21

I 32 035/27
cm +20 (alla penna), 27



P 33 320/11
cm +11x7



P 32 630/26
cm +26x19

P 32 630/37
cm +37x28



I 31 260/10
cm +10x8,5,6



P 33 310/18
cm +18x24



P 33 250/12
cm +10,3x8,9

P 33 250/21
cm +21x18

P 33 250/27
cm +27x22

P 33 250/40
cm +40x34

P 33 250/50
cm +50x50



P 33 200/08
cm +8x8

P 33 200/11
cm +11x11

P 33 200/15
cm +15x15

P 33 200/20
cm +20x20

P 33 200/30
cm +30x30

P 33 200/50
cm +50x50



P 33 340/08
cm ±8x8,5



P 33 210/12
cm ±12x9,5

P 33 210/30
cm ±30x24

P 33 210/20
cm ±20x14

P 33 210/45
cm ±45x28



P 33 290/20
cm ±20x20



P 33 360/11
cm ±10,5x12



Uccelli

P 31 087/07
cm ±7x10



Volo di Gabbiani

P 31 083/08
cm ±8x13,5



Chiave di Violino

P 31 082/06
cm ±6x11,5



Anelli Allacciati

P 31 090/03
cm ±3x5

P 31 090/04
cm ±4x7

STATUE
E BUSTI



STATUE



statue

statues

statues

estatuas

statuen



Madonna

T 35 082/26
cm :26x7,5-ø7

T 35 082/38
cm :38x8,5-ø7,5



Madonna

P 35 058/38
cm :38x7,5-ø8,5

T 35 069/37
cm :37x7,5-ø7



Madonna

P 35 173/41
cm :41x8,5-ø8,5

T 35 184/40
cm :40x8,5-ø6

T 35 184/63
cm :63x14,5-ø8x9



Madonna

T 35 446/65
cm :65x14,5-ø10,5x9



Madonna

T 35 003/60
cm :60x15,5-ø12x12



Madonna

T 35 264/61
cm :63x15,5-ø14x10,5



STATUE



Madonna

35 250/60
cm ±60 ↗ 14x14



Madonna

36 926/65
cm ±63x16 ↗ 14x13,5
Fuso a cera persa



Madonna

37 472/43
cm ±43x17 ↗ 10x9

37 472/57
cm ±57x23 ↗ 12x11

STATUE



statue

statues

statues

estatuas

statuen



Madonna di Lourdes

P 35 546/28
cm :28x8,5

T 35 548/26
cm :26,5x8,5x7x6,5

T 35 548/41
cm :41x12,5x11x10,5



Madonna di Lourdes

T 35 548/54
cm :54x16,5x14x15

T 35 548/80
cm :80x24,5x21x19



Madonna di Lourdes

T 36 983/60
cm :60x14,5x12x12
Fuso a cera persa



Madonna di Lourdes

P 35 014/40
cm :40x11,5x14

T 35 025/38
cm :38x11,5x10



Madonna Immacolata

P 35 581/28
cm :28x10,5↔8,5

T 35 583/26
cm :26,5x11↔7x6,5

T 35 583/41
cm :41x17,5↔11x10



Madonna Immacolata

T 35 583/54
cm :54,5x24↔14,5x13,5

T 35 583/80
cm :80,5x34,5↔22x19,5



Madonna Immacolata

T 37 255/80
cm :83x33↔19x19
Fuso a cera persa



Madonna di Fatima

T 35 215/60
cm :60,5x21,5↔10x9

T 35 215/78
cm :78x30↔13,5x14,5



Madonna di Fatima
(con corona dorata)

T 35 223/74
cm :75x21,5↔16x16

T 35 223/96
cm :96,5x30↔20,5x20,5

STATUE



statue

statues

statues

estatuas

statuen



Madonna col Bambino

37 072/53
cm :53x17,5x11
Fuso a cera persa



Madonna col Bambino

35 151/41
cm :41x9,5x8,5
35 162/40
cm :40x9,5x5
35 162/63
cm :63x13,5x8,5x5



Madonna col Bambino

35 270/43
cm :43x10,5x8,5



Madonna del Carmine

35 300/65
cm :65x18x16



Madonna del Carmine

37 007/80
cm :80x28x18x17
Fuso a cera persa



STATUE



Madonna col Bambino

37 211/39
cm 39,5x10x10

37 211/50
cm 50x13x12

37 211/90
cm 90x27x24,5x21,5
Fuso a cera persa



Madonna col Bambino

37 440/93
cm 93x26x26
Fuso a cera persa



Madonna col Bambino

37 510/55
cm 56x15,5x15,5
Fuso a cera persa



Madonna col Bambino

37 500/73
cm 73x21x19
Fuso a cera persa

STATUE



statue

statues

statues

estatuas

statuen



Madonna

37 472/145
cm 137x54x34x28
Fuso a cera persa

statue

statues

statues

estatuas

statuen



STATUE



Ricordo

36 915/55
cm :55x25,24x12

36 915/124
cm :125x59,55x28
Fuso a cera persa

STATUE



statue

statues

statues

estatuas

statuen



Gettafiori

37 243/90
cm :90x40x55
Fuso a cera persa



Gettafiori

35 110/41
cm :41x16x27



Offerta

35 149/43
cm :42,5x17x15x25



Gettafiori

37 180/87
cm :87x46x68
Fuso a cera persa



Pregghiera

37 860/90
cm :90x36x67
Fuso a cera persa



STATUE



Gettafiore

37 210/67
cm 46,7x45x53
Fuso a cera persa



Gettafiore

37 235/83
cm 48,3x50x30
Fuso a cera persa



Pregiera

37 825/79
cm 46,9x69x115
Fuso a cera persa

STATUE



statue

statues

statues

estatuas

statuen



Gettafiori

36 906/104
cm ±104x33, ±22,5x40
Fuso a cera persa



Gettafiori

37 068/45
cm ±45x26, ±14x17
Fuso a cera persa



Pregghiera

35 606/63
cm :63x18,↔15,5x16



Gettafiori

37 061/80
cm :80x30,↔20x20
Fuso a cera persa

STATUE



statue

statues

statues

estatuas

statuen



Invocazione

T 35 093/43
cm +43x34,5...13x24



Gettafiore con colomba

T 37 117/87
cm +87...57x72
Fuso a cera persa



Gettafiore con colomba

T 35 050/45
cm +45x35...23,5x28



Offerta con colomba dorata

36 904/100
cm :100x47↔20x19

36 904/131
cm :131x25↔24x54
Fuso a cera persa

STATUE



statue

statues

statues

estatuas

statuen



Cristo

35 207/40
cm :40x9,5-ø6

35 207/63
cm :63x16-ø10x9



Sacro Cuore

35 524/28
cm :28x8,5

35 526/26
cm :26x8,5-ø7

35 526/41
cm :41x13-ø10x11



Sacro Cuore

36 948/63
cm :63x17,5-ø13x12
Fuso a cera persa



Sacro Cuore

35 047/39
cm :39x12,5-ø10



Sacro Cuore

37 288/80
cm :80x30, →23,5x20
Fuso a Cera Persa



Sacro Cuore

36 961/60
cm :60x21, →15,5x15
Fuso a cera persa



Sacro Cuore

35 526/54
cm :54x17, →12,5x14
35 526/80
cm :80x25, →21x19

STATUE



statue

statues

statues

estatuas

statuen



Sacro Cuore di Montmartre

36 881/44

cm :44x31,↔13,5x12

36 881/61

cm :61x46,↔17x14,5



Cristo

37 186/62

cm :62,↔14x14

37 186/83

cm :83,↔18x18,5

statue

statues

statues

estatuas

statuen



STATUE



Sacro Cuore

37 266/110
cm :109x36.-32x31,5
Fuso a cera persa

STATUE



statue

statues

statues

estatuas

statuen



Cristo

37 916/89
cm :89x50 →20x30
Fuso a cera persa



Cristo sulle acque

37 251/104
cm :104x61 →28x42
Fuso a cera persa

statue

statues

statues

estatuas

statuen



STATUE



Redentore

37 552/175
cm 175x88x25x60
Fuso a cera persa

STATUE



statue

statues

statues

estatuas

statuen



Redentore

35 420/45
cm 45,19x25



Cristo Invocante

35 674/55
cm 55x40,21x47



Cristo Implorante

35 116/44
cm 44x38,26,14,5x24



Redentore

T 37 990/89
cm ±100,42x55
Fuso a cera persa



Cristo Invocante

T 37 585/103
cm ±101x68,46x87
Fuso a cera persa



Cristo nell'orto

T 37 984/80
cm ±80,40x57
T 37 984/110
cm ±110x85,45x55
Fuso a cera persa



Passione di Cristo

37 690/101
cm ±135, ±126x43
Fuso a cera persa



Passione di Cristo

37 700/35
cm ±35, ±8x14
Fuso a cera persa



Cristo con Croce

37 608/115
 cm ±112x55, →45x72
 Fuso a cera persa



Cristo con Croce

36 892/76
 cm ±76x35, →22x43

STATUE



statue

statues

statues

estatuas

statuen



Resurrezione

37 951/100

cm 199x61 ø25

Fuso a cera persa



Pietà

37 404/100
cm :100,5x74,5x41,5

37 404/120
cm :116,5x100x52
Fuso a cera persa

STATUE



statue

statues

statues

estatuas

statuen



Pietà

35 561/55
cm :55x18,5↔16x17

35 561/80
cm :81,5x32↔29x28



Pietà

36 879/42
cm :42x29↔29x14

36 879/55
cm :53x39↔38x18,5

36 879/71
cm :71x51↔51x23,5
Fuso a cera persa



Pietà

37 820/63
cm :63↔100x49
Fuso a cera persa



Pietà

37 109/92
cm :92↔75x120
Fuso a cera persa



Redenzione

37 698/124
cm 124x82x55x45
Fuso a Cera Persa

STATUE



statue

statues

statues

estatuas

statuen



Angelo

37 236/13
cm ±13x8,±4x5
Fuso a cera persa



Angelo

37 205/11
cm ±11x7,5,±5x7
Fuso a cera persa



Angelo

37 221/06
cm ±6x12,±12x5
Fuso a cera persa



Angelo

37 240/10
cm ±10x8



Angelo

37 220/08
cm ±8x7,5



Angelo

37 250/13
cm ±13x7,5



Angelo

35 218/44
cm ±43x24,±8,5x12



Angelo

35 030/25
cm ±25x10,±10x13,5



Angelo

35 719/26
cm ±26x10,5,±10,5x13



Angelo

37 803/52
cm :52x17x17
Fuso a cera persa



Angelo gettafiore

37 206/30
cm :30x10,5x10x11
Fuso a Cera Persa



Angelo gettafiore

37 219/30
cm :30x10,5x10x11
Fuso a Cera Persa



Madonna col Bambino

37 072/30
cm :30x9x8x7
Fuso a Cera Persa



Madonna col Bambino

37 128/30
cm :30x9x8x7
Fuso a Cera Persa

STATUE



statue

statues

statues

estatuas

statuen



Angelo

35 208/06
cm :5,5x18,5-18x9,5
Fuso a Cera Persa



Angelo

35 214/06
cm :5,5x18,5-18x9,5
Fuso a Cera Persa



Angelo

35 245/06
cm :5,5x18,5-18x9,5
Fuso a Cera Persa



Angelo

35 228/06
cm :5,5x18,5-18x9,5
Fuso a Cera Persa



Angelo

35 210/11
cm :11x10,5-10x7
Fuso a Cera Persa



Angelo

35 217/11
cm :11x10,5-10x7
Fuso a Cera Persa



Angelo

35 226/11
cm :11x10,5-10x7
Fuso a Cera Persa



Angelo

35 220/11
cm :11x10,5-10x7
Fuso a Cera Persa



STATUE



Angelo

T 35 212/05
cm :5x16,↔16x9
Fuso a Cera Persa



Angelo

T 35 251/05
cm :5x16,↔16x9
Fuso a Cera Persa



Angelo

T 35 267/05
cm :5x16,↔16x9
Fuso a Cera Persa



Angelo

T 35 260/05
cm :5x16,↔16x9
Fuso a Cera Persa

Esempio di applicazione



STATUE



statue

statues

statues

estatuas

statuen



patina bianca

Angelo gettafiore

37 200/57

cm ±57x26,±14x17

37 200/100

cm ±100x43,±23x28

Fuso a Cera Persa



patina verde

Angelo gettafiore

37 208/57

cm ±57x26,±14x17

37 208/100

cm ±100x43,±23x28

Fuso a Cera Persa



Angelo gettafiori

37 064/57

cm +57x26,14x17

37 064/100

cm +100x43,23x28

37 064/180

cm +180x83,51x41,5

Fuso a Cera Persa



Angelo

37 676/101

cm +101,38x62

Fuso a cera persa

STATUE



statue

statues

statues

estatuas

statuen



San Pio

35 001/38
cm :38x14,9x9,5



San Pio

35 350/35
cm :35,9,5x9,5



San Pio

36 605/62
cm :62x28,5,14x13
Fuso a cera persa



San Pio

37 110/100
cm :100x32,5,30x29
Fuso a cera persa



San Pio

35 360/63
cm :63,17x17

statue

statues

statues

estatuas

statuen



STATUE



San Pio

37 115/174
cm 172x77x45x50
Fuso a cera persa

STATUE



statue

statues

statues

estatuas

statuen



S. Antonio

36 972/53
cm :53x16,5x15x12,5



S. Antonio

37 131/75
cm :75x26x24x21
Fuso a cera persa



S. Francesco

36 170/62
cm :62x16x14
36 170/94
cm :94x24x23
Fuso a cera persa



S. Giuseppe

37 736/51
cm :51,5x13,5x13,5

37 736/80
cm :80,5x21x18
Fuso a cera persa



S. Rita

37 995/50
cm :50x18,5x12x13
Fuso a cera persa



Papa Giovanni XXIII

37 107/98
cm +98x40x30x26
Fuso a cera persa



Giovanni Paolo II

37 050/60
 cm :60x27,21x21
 Fuso a cera persa

37 050/200
 cm :200x80,68x68
 Fuso a cera persa



Giovanni Paolo II

37 048/30
 cm :30x12,614

BUSTI



busti

bustes

busts

bustos

büste



Madonna

33 120/37
cm :37,↔33x18



Madonna

33 295/40
cm :42x35,5↔20x19



Madonna

33 284/43
cm :43x38↔36x21
Fuso a cera persa



Redentore

33 080/44
cm :44x31
Fuso a cera persa



Cristo

33 273/40
cm :40x35,5↔19x18,5



Cristo

33 307/35
cm :33x30↔22x14
Fuso a cera persa



Ultima Cena

37 873/78
cm 78x198x37 - 195x30
fuso a cera persa

CAPPELLE E SOSTEGNI



LAMPADE PENSILI

LAVORAZIONE TIPO "MURANO"



lampade
pensili

lampes
suspendues

hanging
lamps

lamparas
colgantes

hängelampen



28 418/100
cm ±100, ø 40



LAMPADE PENSILI



28 410/100
cm ±100, ø 40



28 412/100
cm ±100, ø 40

LAMPADE PENSILI



lampade
pensili

lamps
suspendues

hanging
lamps

lamparas
colgantes

hängelampen



28 469/100
cm ±100, ø 52

28 469/134
cm ±134, ø 52
con anello bronzo



28 458/100
cm ±100, ø 52
con anello dorato



28 511/100
cm ±100, ø 30
con anello bronzo



28 513/100
cm ±100, ø 30
con anello dorato



LAMPADE PENSILI



28 414/90
cm +90, ø 39

28 414/135
cm +135, ø 39



28 287/90
cm +90, ø 35



28 221/60
cm +60, ø 22



28 265/63
cm +63, ø 24



28 254/63
cm +63, ø 24

28 254/97
cm +97, ø 24

LAMPADE PENSILI



lampade
pensili

lampes
suspendues

hanging
lamps

lamparas
colgantes

hängelampen



28 231/90
cm ±90, ø 29



28 378/90
cm ±90, ø 29

28 378/124
cm ±124, ø 29



28 334/100
cm ±100x30



28 298/90
cm ±90, ø 35



LAMPADE PENSILI



28 100/72
cm ±72, ø17,5



28 367/108
cm ±108, ø 46



28 010/78
cm ±72, ø42

LAMPADE PENSILI



lampade
pensili

lampes
suspendues

hanging
lamps

lamparas
colgantes

hängelampen



28 120/100
cm ±100, ø40



P 7 375/56
cm ±56x13,±16



P 7 380/46
cm ±46x10,±13



Plafoniera

28 163/20
cm ±11, ø20



Plafoniera

28 152/20
cm 19,5x19,5,±19,5



LAMPADE PENSILI



Mensola

P 77 222 /06
cm ±6x20,±12



Catena

28 015/100
Maglia
cm ±7,5x3
Da ordinare
al metro



Catena

28 026/100
Maglia
cm ±7,5x4
Da ordinare
al metro



Catena

28 048/100
Maglia
cm ±9,5x4,5
Da ordinare
al metro



Catena

28 059/100
Maglia
cm ±7,5x2,5
Da ordinare
al metro



Rosone
per lampade pensili

28 607/15
cm ±15,±07

28 607/17
cm ±17,±011



Gancio Reggicatena

25 604/5
cm ±5x5



Colonna per recinti
tombe e monumenti

25 615/40
cm ±40x04,±8

25 615/60
cm ±60x04,±8



Braccio per lampade

28 106/22
cm ±13,5x22

28 106/34
cm ±13,5x34

CANDELABRI



candelabri candelabres altar crucifixes candelabros kandelaber
 crocefissi et crucifix and candelabras crucijos altarkreuze
 per altare pour autel para altares



25 227/31
 cm 431x15,ø9,5
25 227/36
 cm 436x15,ø9,5



25 422/10
 cm 410,ø9,5
25 422/16
 cm 416,ø9,5



25 216/43
 cm 443x15,ø11



25 411/24
 cm 424,ø11



25 193/40
 cm 440x16,ø10

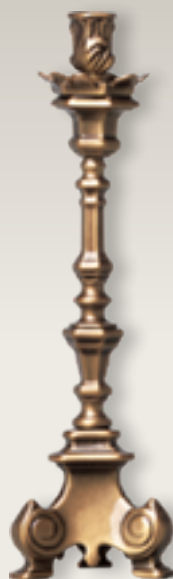

25 397/33
 cm 433,ø10

candelabri candelabres altar crucifixes candelabros candelaber
crocefissi et crucifix and candelabras crucijos altarkreuze
per altare pour autel para altares



CANDELABRI



25 171/36
cm ±36x16 ↗ ↘ ø8



25 375/27
cm ±27 ↗ ↘ ø8



25 182/35
cm ±35x16 ↗ ↘ ø8



25 386/24
cm ±24 ↗ ↘ ø8

STAFFE
BORCHIE
ANELLONI





staffe
borchie
anelloni

etriers
cabochons
anneaux

brakets
studs
rings

garras
clavos
anillas

stüzhälter
beschläge
ringe

Staffe per sostegno lapidi a spessore variabile

Etriers pour les soutien des
enfeux d'épaisseur variable

Brackets for niches support
with variable thickness

Garras para sostener lapidas
de espesor variable

Grabstein-stützhalter mit
verstellbarer dicke

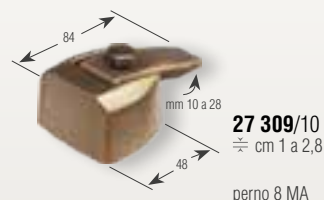
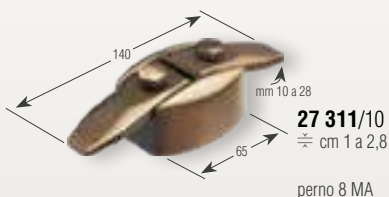
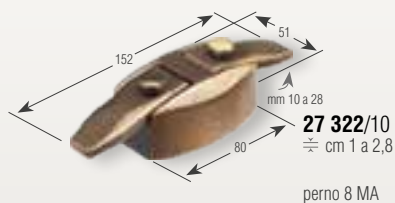

Staffe per ossari
Etriers pour ossuaires
Brackets for ossuaries
Garras para osarios
Halter für ossarium

Tipo Parma

26 161/30
ø cm 3

26 161/40
ø cm 4

26 161/55
ø cm 5,5
con perno 8 MA
in acciaio inox

26 161/75
ø cm 7,5
con perno 12 MA
in acciaio inox



Rondella regolabile per diversi spessori di marmo.

Rondelle réglable en fonction des
différentes épaisseurs de marbre.
Adjustable washer for different
thickness of marble.

Arandela regulable para diversos
espesores.

Regulierbare unterlegscheiben für
verschiedene Marmor-Dichten.

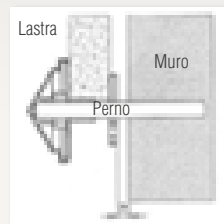

L'aumento della distanza tra la
rondella e il calcestruzzo (h) è
direttamente proporzionale alla
perdita di portata.

staffe
borchie
anelloni

étriers
cabochons
anneaux

brakets
studs
rings

garras
clavos
anillas

stuzhälter
beschläge
ringe



STAFFE

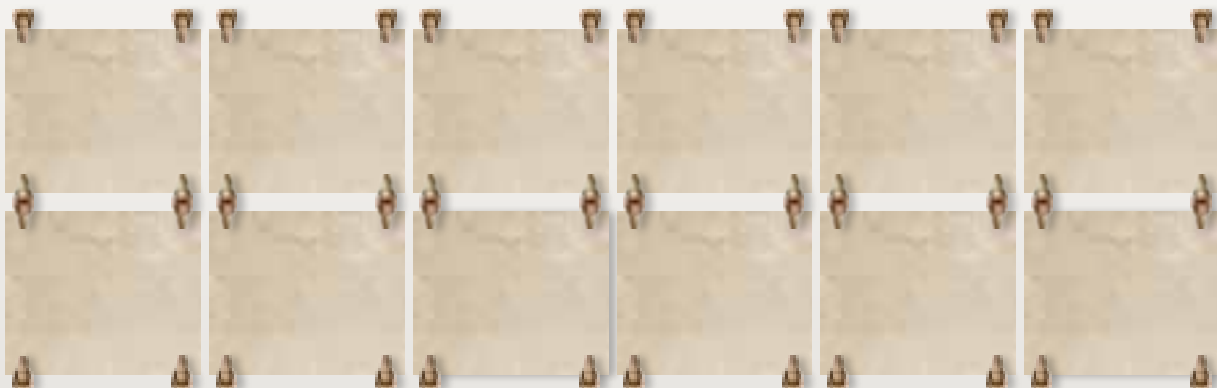

Disponibili anche in acciaio inox, vedi pag. 264-265 A RICHIESTA sarà fornita la documentazione tecnica relativa alla portata massima

Perni in acciaio inox
compresi nel prezzo.

Pivots en acier inox
compris dans le prix.

Stainless steel pivots
included in price.

Pernios en acero inox
incluídos en precio.

Bolzen aus rostfreiem stahl
im preis einschliesslich.

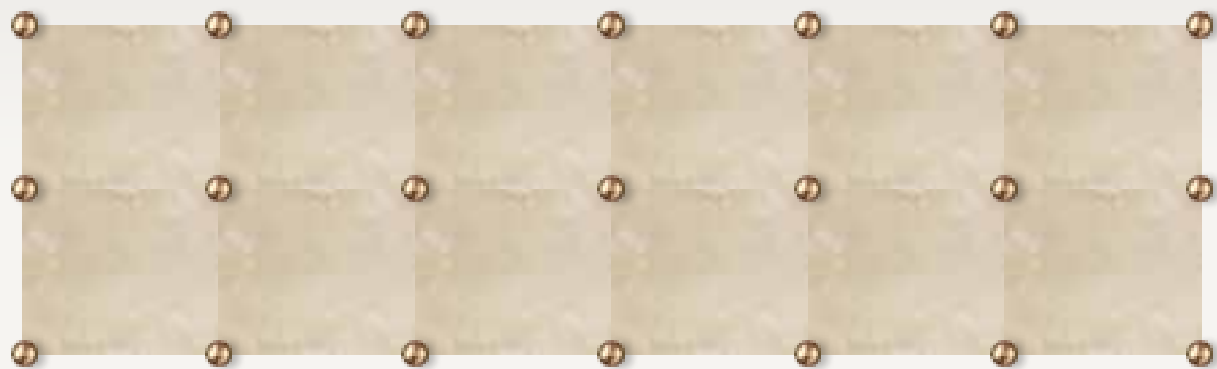

STAFFE



staffe
borchie
anelloni

étriers
cabochons
anneaux

brackets
studs
rings

garras
clavos
anillas

stüzhälter
beschläge
ringe

Staffe Classic per sostegno lapidi a spessore variabile

Etriers pour les soutien
des enfeux d'épaisseur
variable

Brackets for niches
support with variable
thickness

Garras para sostener
lapidas de espesor
variable

Grabstein-stützhälter mit
verstellbarer dicke

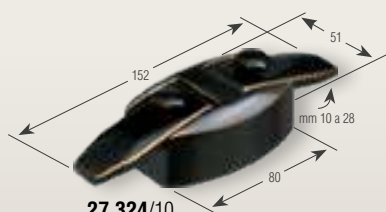

27 324/10
≙ cm 1 a 2,8

perno 8 MA

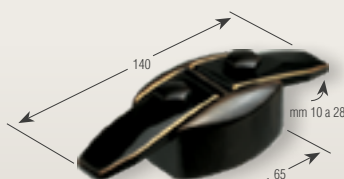

27 314/10
≙ cm 1 a 2,8

perno 8 MA

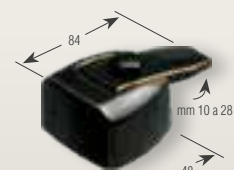

27 304/10
≙ cm 1 a 2,8

perno 8 MA

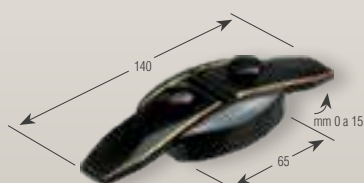

27 314/00
≙ cm 0 a 1,5

perno 6 MA



27 304/00
≙ cm 0 a 1,5

perno 6 MA

Staffe con aletta lunga per sostegno lapidi a spessore variabile

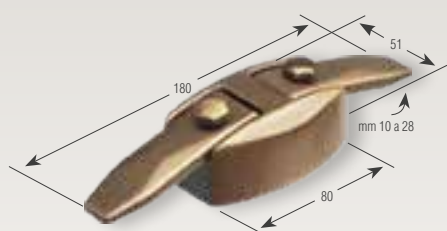

27 344/10
≙ cm 1 a 2,8

perno 8 MA

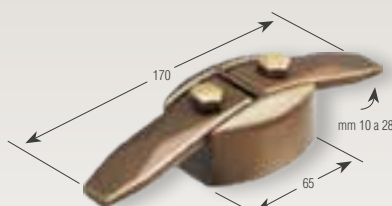

27 355/10
≙ cm 1 a 2,8

perno 8 MA

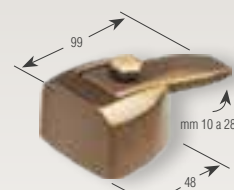

27 333/10
≙ cm 1 a 2,8

perno 8 MA

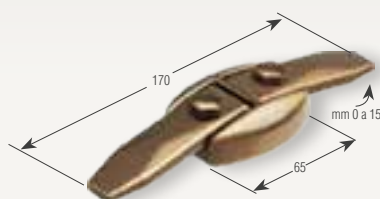

27 355/00
≙ cm 0 a 1,5

perno 6 MA

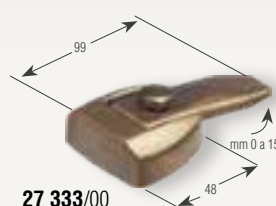

27 333/00
≙ cm 0 a 1,5

perno 6 MA

Perni in acciaio inox compresi nel prezzo.

Pivots en acier inox
compris dans le prix.

Stainless steel pivots
included in price.

Pernios en acero inox
incluidos en precio.

Bolzen aus rostfreiem stahl
im preis einschliesslich.

A RICHIESTA sarà fornita la documentazione tecnica relativa alla portata massima

staffe
borchie
anelloni

étriers
cabochons
anneaux

brackets
studs
rings

garras
clavos
anillas

stüzhälter
beschläge
ringe



STAFFE

Staffe per sostegno lapidi a spessore variabile

Etriers pour les soutien
des enfeux d'épaisseur
variable

Brackets for niches
support with variable
thickness

Garras para sostener
lapidas de espesor
variable

Grabstein-stüzhälter mit
verstellbarer dicke

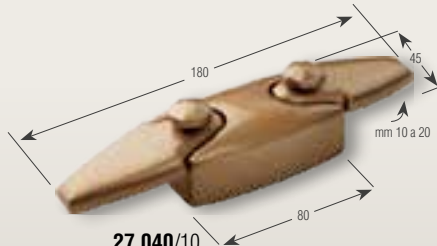

27 040/10
≙ cm 1 a 2

perno 8 MA

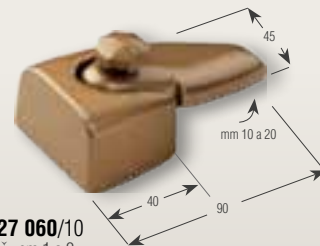

27 060/10
≙ cm 1 a 2

perno 8 MA

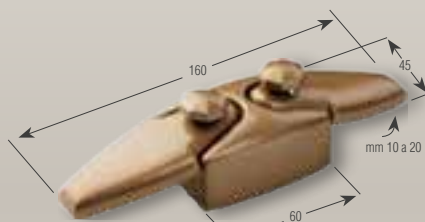

27 050/10
≙ cm 1 a 2

perno 8 MA

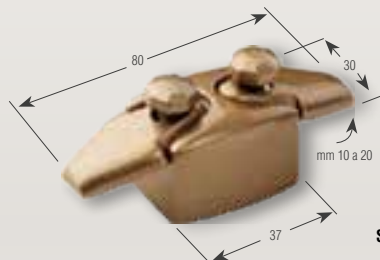

27 020/10
≙ cm 1 a 2

perno 6 MA

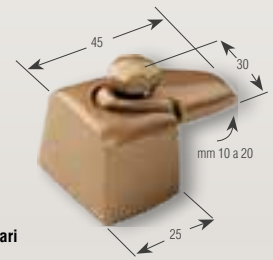

27 030/10
≙ cm 1 a 2

perno 6 MA

Staffe per ossari

Etriers pour ossuaires

Brackets for ossuaries

Garras para osarios

Halter für ossarium

Perni in acciaio inox compresi nel prezzo.

Pivots en acier inox
compris dans le prix.

Stainless steel pivots
included in price.

Pernios en acero inox
incluidos en precio.

Bolzen aus rostfreiem stahl
im preis einschliesslich.



27 120/00
≙ cm 0

perno 6 MA

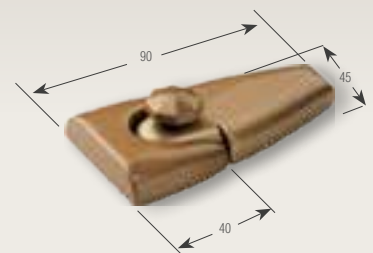

27 130/00
≙ cm 0

perno 6 MA

A RICHIESTA sarà fornita la documentazione tecnica relativa alla portata massima

STAFFE



staffe
borchie
anelloni

etriers
cabochons
anneaux

brackets
studs
rings

garras
clavos
anillas

stüzhälter
beschläge
ringe

Staffe per sostegno lapidi a spessore variabile

Etriers pour les soutien
des enfeux d'épaisseur
variable

Brackets for niches
support with variable
thickness

Garras para sostener
lapidas de espesor
variable

Grabstein-stützhalter mit
verstellbarer dicke

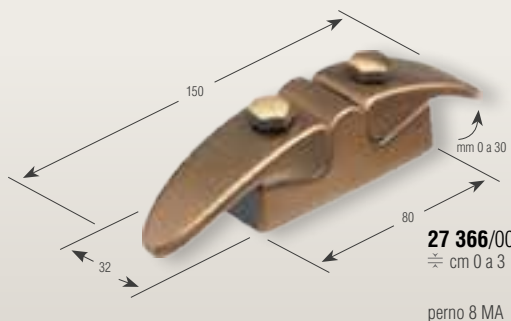

perno 8 MA



perno 8 MA



perno 8 MA

Perni in acciaio inox
compresi nel prezzo.

Pivots en acier inox
compris dans le prix.

Stainless steel pivots
included in price.

Pernios en acero inox
incluidos en precio.

Bolzen aus rostfreiem stahl
im preis einschliesslich.

Staffe Practica per sostegno lapidi a spessore variabile

Etriers pour les soutien
des enfeux d'épaisseur
variable

Brackets for niches
support with variable
thickness

Garras para sostener
lapidas de espesor
variable

Grabstein-stützhalter mit
verstellbarer dicke

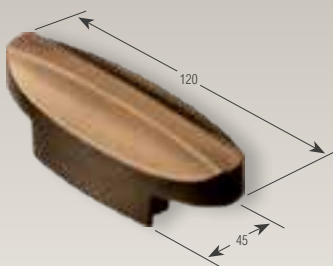
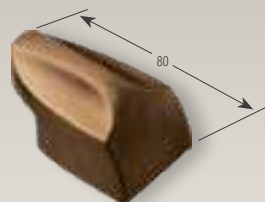

A
Vite a testa
esagonale con
dado e rondella
95 820/100
Ø 8x100 zincato

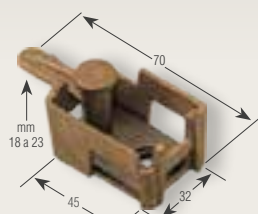

27 440/18
cm 1,8 a 2,3

perno 8 MA

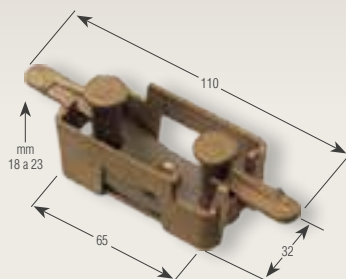

27 461/18
cm 1,8 a 2,3

perno 8 MA



B
Vite mordente
a testa esagonale con
tassello Fischer
95 831/100
Ø 8x100 zincato

Per le staffe PRACTICA, specificare
sempre all'ordine il tipo di
fissaggio (A o B) ed il relativo
codice. I sistemi di fissaggio non
sono compresi nel prezzo.

A RICHIESTA sarà fornita la documentazione tecnica relativa alla portata massima

staffe
borchie
anellini

etriers
cabochons
anneaux

brakets
studs
rings

garras
clavos
anillas

stuzhälter
beschläge
ringe



BORCHIE

Borchie con funzione prevalentemente decorativa

Cabochons avec une
fonction essentiellement
decorative

Studs prevalently for
decorative use

Clavos
prevalentemente
decorativos

Beschläge mit
vorwiegend dekorativer
funktion



26 079/30
ø cm 3
26 079/40
ø cm 4
26 079/55
ø cm 5,5
perno 5 MAx60

26 079/830
ø cm 3
26 079/840
ø cm 4
26 079/855
ø cm 5,5
26 079/75
ø cm 7,5
perno 8 MAx90



26 074/30
ø cm 3
26 074/55
ø cm 5,5
perno 5 MA x 60



26 092/50
ø cm 5
perno 5 MAx60
26 092/850
ø cm 5
perno 8 MAx90



26 104/45
ø cm 4,5
perno 5 MAx60



26 024/30 cm 3x3
26 024/40 cm 4x4
26 024/50 cm 5x5
perno 5 MAx60
26 024/60 cm 6x6
26 024/80 cm 8x8
perno 6 MAx60



26 035/20 cm 2x2
26 035/30 cm 3x3
26 035/40 cm 4x4
26 035/50 cm 5x5
perno 5 MAx60



26 034/30 cm 3x3
26 034/40 cm 4x4
26 034/50 cm 5x5
perno 5 MA x 60



26 046/30 cm 3x3
26 046/40 cm 4x4
26 046/45 cm 4,5x4,5
perno 5 MAx60



26 057/40 cm 4x4
perno 5 MAx60



26 115/60 ø cm 6
perno 6 MAx60



26 081/40 ø cm 4
perno 5 MAx60
26 081/60 ø cm 6
perno 6 MAx60



26 126/02 ø cm 2
26 126/03 ø cm 3
26 126/04 ø cm 4
26 126/05 ø cm 5
perno 5 MAx60



26 183/20 ø cm 2
26 183/30 ø cm 3
26 183/40 ø cm 4
26 183/50 ø cm 5
con vite a legno e
foro passante

BORCHIE



staffe
borchie
anelloni

etriers
cabochons
anneaux

brakets
studs
rings

garras
clavos
anillas

stuzhälter
beschläge
ringe

Borchie per sostegno lapidi

Cabochons pour le soutien des enfeux

Supporting studs for niches

Clavos para sostener lapidas

Beschläge als grabsteinstützen

Borchie tipo Ortona



26 206/60
cm 6x6



26 194/60
cm 6x6



26 092/S
ø cm 5
con perno fuso
12 MAx12



26 081/S
ø cm 6
con perno fuso
12 MAx12



Tipo Spagna
26 228/55
ø cm 5,5
perno 6 MAx60



Pomolo per sigilli
26 137/25
ø cm 2,5
perno 10 MAx30



Pomolo per sigilli
26 159/35
ø cm 4
perno 12 MAx40



26 148/25
ø cm 2,5
con zanca cm 7



26 148/S
ø cm 2,5
passo 8 MA
(perno non incluso)

Borchie laterali ad innesto tipo Umbria



26 068/40
cm 4x4

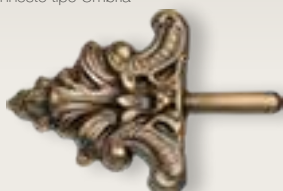

26 172/50
cm 5x5



26 401/60
cm +5,5x6,5x6,5
supporto superiore con
placca fermaloculo mobile



26 412/65
cm +3x6,5x6
supporto inferiore

staffe
borchie
anelloni

étriers
cabochons
anneaux

brakets
studs
rings

garras
clavos
anillas

stuzhälter
beschläge
ringe



ANELLONI E ACCESSORI



26 558/80 ø cm 8
26 558/105 ø cm 10,5
il ø 8 è predisposto
anche per chiavistello 26 365



26 547/70 ø cm 7
26 547/85 ø cm 8,5
26 547/100 ø cm 10
il ø 7 e 8,5 sono predisposti
anche per chiavistello 26 365



26 718/65 cm ±6,5x8,5
26 718/75 cm ±7,5x10



26 525/125 cm ±12,5x11,5



26 525/160 cm ±16x16



26 514/160 cm ±16x16

Gli anelloni hanno funzione decorativa e non portante

Les anneaux ont une fonction décorative et non portante

Decorative rings, not for support function

Las anillas cumplen una función puramente decorativa

Die ringe haben nur eine ausschmückende, keine lasttragende funktion



Chiavistello per spessore marmo da:

26 365/25 cm 2,5
26 365/30 cm 3
26 365/35 cm 3,5
specificare lo spessore della lastra



Chiavistello con filettatura

26 354/05 - 5 MA
26 354/06 - 6 MA
26 354/08 - 8 MA



Cerniera

95 303/0 cm 12x12



Viti a legno (per borchie)

95 393/60
5 MAx60
95 393/70
5 MAx70
95 393/80
5 MAx80



Viti a legno

95 416/60
mm 60



Perni

95 405/60
4 MAx60
95 507/60
5 MAx60
95 507/80
5 MAx80
95 609/60
6 MAx60
95 609/80
6 MAx80



Zanca

95 382/60
5 MAx60
95 382/80
5 MAx80
95 382/100
5 MAx100
95 382/150
6 MAx150



Tasselli metallici ad espansione

95 905/6 - 6 MA
95 905/8 - 8 MA
95 905/10 - 10 MA



PREFABBRICAZIONE LEGGERA PER IL SETTORE CIMITERIALE

Matthews International S.p.A.

Progetta, realizza e commercializza strutture modulari prefabbricate in acciaio e vetroresina/alluminio che permettono di eseguire ampliamenti cimiteriali anche in presenza di situazioni complesse.



I nostri punti di forza:

- soluzioni ottimali per ogni area cimiteriale;
- valutazioni direttamente in loco e analisi di fattibilità;
- progettazione tecnica preliminare e realizzazione;
- basso impatto ambientale.



Vantaggi delle nostre strutture:

- realizzazione di ampliamenti cimiteriali anche in situazioni precarie, dove non sarebbe possibile aprire un tradizionale cantiere edile;
- velocità di installazione;
- assenza di aperture di cantiere e quindi riduzione dei disagi per l'utenza;
- spese di manutenzione limitate e contenute negli anni;
- il basso peso e la robustezza della struttura permettono il posizionamento anche su solai esistenti;
- architettura innovativa;
- qualità dei materiali utilizzati.

LA NOSTRA OFFERTA

Matthews International S.p.A.

si rende disponibile a valutare la fattibilità di realizzazione di strutture e a elaborare un progetto nelle seguenti modalità:

- Appalti in concessione
- Partecipazione a PROJECT FINANCING
- Vendite dirette

Offriamo la nostra esperienza internazionale e la solidità del nostro gruppo, per fornirvi un servizio completo e flessibile, rivolto a chiunque necessiti di interventi di questo tipo, con un servizio “chiavi in mano”, dalla progettazione all’assistenza post-vendita.

SPECIFICHE TECNICHE

LOCULI (sia di fascia che di punta), TOMBE GENTILIZIE, EDICOLE DI FAMIGLIA

Realizzati in acciaio e vetroresina/alluminio, i nostri loculi prefabbricati possono essere composti da:

- **una struttura portante**
formata da pilastri e traversi in acciaio zincato a caldo e/o alluminio, completi di piastre alla base per la regolazione ed il fissaggio;
- **il cassero**, realizzato con pannelli di alluminio giuntati tra loro con saldatura continua e/o in vetro resina in guscio unico. Sono a perfetta tenuta stagna, rendendo il loculo perfettamente impermeabile.
- Possibilità di predisposizione per impianto per luce votiva;
- Rivestimento dei manufatti con marmi, graniti o altre pietre.



OSSARI E CINERARI (sia di fascia che di punta)

I nostri ossari e cinerari sono composti da:

- una **struttura portante**, composta da montanti e traversini in alluminio e/o con guscio in vetroresina, completa di piedini regolabili;
- **giunti in alluminio** pressofuso ad incastro;
- predisposizione per impianto a luce votiva;
- rivestimento dei manufatti con marmi, graniti o altre pietre.



Questo mix di resistenza e leggerezza offre una struttura con peso nettamente inferiore alla media, una maggiore precisione in fase di montaggio e la possibilità di intervenire in aree non altrimenti utilizzabili.

CREMAZIONE
CINERARI E OSSARI



CINERARI E OSSARI

SERIE OLMO



cinerari
ed ossari

vases et
lampes pour
colombarium

accessories
for ossuaries

oasarios

zubehör
für ossarium



P 7 004/16
cm ±16x8,7



P 1 019/13P ⓘ
cm ±13x8,7,5



P 7 068/16
cm ±16x8,7



P 1 052/13P ⓘ
cm ±13x8,7,5



P 9 531/16
cm ±16x8,7



P 2 192/13P ⓘ
cm ±13x8,7,5



P 7 129/16
cm ±16x8,7



P 1 073/13P ⓘ
cm ±13x8,7,5



P 7 154/16
cm ±16x8,7



P 1 087/13P ⓘ
cm ±13x8,7,5

cinerari
ed ossari

vases et
lampes pour
colombarium

accessories
for ossuaries

ossarios

zubehör
für ossarium



CINERARI E OSSARI BRONZO



P 7 021/15
cm ±15x7,2x7,5



P 4 010/13 ⓘ
cm ±13x8,5x9



P 9 986/13
cm ±13,5x7,5x7,5



P 6 972/12 ⓘ
cm ±12x8,2x7,5



P 7 138/15
cm ±16x7,2x7



P 1 034/13P ⓘ
cm ±13x7,5x7,5



P 1 215/09P ⓘ
cm ±10x11,2x7



P 7 301/15
cm ±15x6,2x7



P 5 101/12 ⓘ
cm ±12,5x5,2x6



P 7 012/13
cm ±13x6,5x8



P 5 014/12 ⓘ
cm ±12x6,5x8

CINERARI E OSSARI BRONZO



cinerari
ed ossari

vases et
lampes pour
colombarium

accessories
for ossuaries

oasarios

zubehör
für ossarium



P 7 136/14
cm ±14x7,±7,5



P 1 108/13P ⓘ
cm ±13x7,±7,5



P 7 070/15
cm ±15x7,±7



P 1 120/13P ⓘ
cm ±13x7,±7



P 7 050/15
cm ±15x7,±7



P 1 128/13P ⓘ
cm ±13x7,±7



P 7 240/15
cm ±15x7,±6,5



P 2 140/13R ⓘ
P 2 140/13P ⓘ
cm ±13x8,±7,5
T 2 142/13R ⓘ
cm ±13x8,±4,5x3,5

T 7 242/15
cm ±15x7,±4x3,5



P 7 032/9
cm ±9,5x5,±5,5

T 7 043/9
cm ±9,5x5,±5x5,5



P 1 035/11 ⓘ
cm ±11x5,±5,5

T 1 046/11 ⓘ
cm ±11x5,±6,5



P 7 960/13
cm ±13x6,±6,5



P 2 620/13R ⓘ
cm ±13,5x7,5,±7,5



CINERARI E OSSARI BRONZO



P 7 054/12
cm ±12x7,5

I 7 065/12
cm ±12x7,5



P 1 057/12
cm ±12x7,5

I 1 068/12
cm ±12x7,5



P 9 114/13
cm ±13,5x5,5

I 9 125/13
cm ±13,5x5,5



P 4 698/13
cm ±13x6

I 4 701/13
cm ±13x6



P 9 266/14
cm ±14,5x7

I 9 370/14
cm ±14,5x7



P 5 275/12
cm ±12x7,5

I 5 370/12
cm ±12x7,5



P 7 130/13
cm ±13x7



P 1 270/13R
cm ±12,5x7,5



P 7 115/13
cm ±14x6,5



P 2 570/13R
cm ±13x8,5



P 9 535/15
cm ±14,5x6,5

I 9 546/15
cm ±14,5x6,5



P 5 314/13
cm ±13x7,5

I 5 325/13
cm ±13x7,5

CINERARI E OSSARI BRONZO



cinerari
ed ossari

vases et
lampes pour
colombarium

accessories
for ossuaries

oasarios

zubehör
für ossarium



P 7 190/13
cm ±13x7,±6

I 7 100/13
cm ±13x7,±ø4



P 1 170/13R ⓘ
cm ±13x8,±7,5

I 1 180/13R ⓘ
cm ±13x8,±ø4,5



P 10 085/12
cm ±11,5x9,5,±8,5

I 10 090/12
cm ±11,5x9,5,±ø6



P 1 210/13R ⓘ
cm ±12,5x5,±5,5



P 10 100/12
cm ±12x9,5,±8,5



P 7 072/15
cm ±14x6,±6,5



P 1 134/13R ⓘ
cm ±13,5x8,±7,5



P 10 070/12
cm ±12x9,5,±8,5



P 10 014/09
cm ±9x7,5,±7



P 10 080/10
cm ±9,5x7,±6,5



P 7 019/11
cm ±11x8,±5,7



P 1 013/9 ⓘ
cm ±9x7,±6

cinerari
ed ossari

vases et
lampes pour
colombarium

accessories
for ossuaries

ossarios

zubehör
für ossarium



PORTAORCHIDEA BRONZO



P 2 928/12P
cm ±12x4,5x3,5



P 2 975/12
cm ±12x5x3
con perni
e biadesivo



P 2 958/10
cm ±11x3,5x4
con anello dorato



P 2 936/10
cm ±11x3,5x4



P 2 000/13
cm ±12,5x5,5x4,5
con perni
e biadesivo



P 2 480/10
cm ±10xø4



P 2 470/16
cm ±16xø5,5



P 2 010/14
cm ±14x4x5



P 2 943/12
cm ±12,5x4x4
con biadesivo e perni



P 2 945/12
cm ±12,5x4x4
con biadesivo e perni



Esempio di applicazione
con biadesivo

CINERARI E OSSARI BOTTICINO



cinerari
ed ossari

vases et
lampes pour
colombarium

accessories
for ossuaries

oasarios

zubehör
für ossarium



P 9 531/16
cm ±16x8,7



P 2 192/13P D
cm ±13x8,7,5



P 7 149/14
cm ±14x7,7,5



P 1 157/13P D
cm ±13x7,7,5



P 7 080/15
cm ±15x7,7



P 1 520/13P D
cm ±13x7,7



P 7 270/15
cm ±15x7,7,5



P 2 178/13P D
cm ±13x7,7,5



P 9 607/15
cm ±14,5x6,5,7



P 5 830/13 P
cm ±13x7,7,5

PORTAORCHIDEA



P 2 961/12P D
cm ±12x4,5,3,5



P 2 952/12 D
cm ±12x5,3



P 2 940/12 D
cm ±12,5x4,4



P 2 935/12
cm ±11x3,5,4

con perni e biadesivo

con biadesivo e perni

con perni

con anello di bronzo

cinerari
ed ossari

vases et
lampes pour
colombarium

accessories
for ossuaries

oasarios

zubehör
für ossarium



CINERARI E OSSARI CARRARA



P 7 137/14
cm ±14x7,±7,5



P 1 152/13P ⓘ
cm ±13x7,±7,5



P 7 125/15
cm ±15x7



P 1 124/13P ⓘ
cm ±13x7,±7



P 7 253/15
cm ±15x7,±6,5

I 7 255/15
cm ±15x7,±4X3,5



P 2 101/13 ⓘ
cm ±13x8,±7,5

I 2 112/13 ⓘ
cm ±13x8,±4,5X3,5



P 7 709/13
cm ±13x7,±6



P 1 117/13R ⓘ
cm ±13x8,±7,5



P 9 128/13
cm ±13,5x5,5,±6,5



P 4 695/13P ⓘ
cm ±13x6,±7

PORTAORCHIDEA



P 2 931/10
cm ±11x3,5,±4



P 2 956/12P ⓘ
cm ±12x4,5,±3,5



P 2 977/12 ⓘ
cm ±12x5,±3



P 2 951/12 ⓘ
cm ±12,5x4,±4

con perni e biadesivo

con perni e biadesivo

con perni

CINERARI E OSSARI UNIBLANC



cinerari
ed ossari

vases et
lampes pour
colombarium

accessories
for ossuaries

oasarios

zubehör
für ossarium



P 7 118/14
cm ±14x7,2x7,5



P 1 011/13P ①
cm ±13x7,2x7,5



P 7 129/16
cm ±16x8,2x7



P 1 073/13P ①
cm ±13x8,2x7,5



P 7 244/15
cm ±15x7,2x6,5



P 2 153/13R ①
cm ±13x8,2x7,5



P 9 533/15
cm ±14,5x6,5x7



P 5 312/13 ①
cm ±13x7,2x7,5

PORTAORCHIDEA



P 2 904/12P ①
cm ±12x4,5x3,5

Con perni e biadesivo



P 2 927/12
cm ±11x3,5x4

con anello dorato



P 2 942/12 ①
cm ±12x5x3

con perni e biadesivo



P 2 957/12 ①
cm ±12,5x4,2x4

con perni e biadesivo

cinerari
ed ossari

vases et
lampes pour
colombarium

accessories
for ossuaries

ossari

zubehör
für ossarium



CINERARI E OSSARI DARK



P 7 075/15
cm ±15x7,27



P 1 140/13P ⓘ
cm ±13x7,27



P 9 659/15
cm ±14,5x6,5,27



P 5 553/13 ⓘ
cm ±13x7,27,5



P 19 780/06
cm 6x8

P 19 780/07
cm 7x9

P 19 780/08
cm 8x10



P 21 028/07
cm 7x9

P 21 028/08
cm 8x10

PORTAORCHIDEA



P 2 971/10
cm ±11x3,5,24
con anello dorato

VERDE ALPI



P 1 530/13P ⓘ
cm ±13x7,27



P 7 064/15
cm ±15x7,27

CINERARI E OSSARI

PORCELLANA BIANCO



cinerari
ed ossari

vases et
lampes pour
colombarium

accessories
for ossuaries

oasarios

zubehör
für ossarium



P PO 739/15
cm ±15x8,~8

P PO 177/13 ⓘ
cm ±13x8,5,~9



P PO 737/15
cm ±15x8,~8

P PO 173/13 ⓘ
cm ±13x8,5,~9



P PO 717/15
cm ±15x8,~8

P PO 133/13 ⓘ
cm ±13x8,5,~9



P PO 745/15
cm ±14,5x7,~9

P PO 189/13 ⓘ
cm ±13x8,5,~9,5



P PO 753/15
cm ±14,5x7,~9

P PO 137/13 ⓘ
cm ±13x8,5,~9,5



P PO 755/15
cm ±14,5x8,~9

P PO 205/13 ⓘ
cm ±13x8,~9,5



P PO 759/15
cm ±15x7,5,~9

P PO 213/13 ⓘ
cm ±13,5x8,~9,5

cinerari
ed ossari

vases et
lampes pour
colombarium

accessories
for ossuaries

ossarios

zubehör
für ossarium



CINERARI E OSSARI

PORCELLANA BEIGE



P PO 733/15
cm ±15x8,8



P PO 165/13 ⓘ
cm ±13x8,5,9



P PO 741/15
cm ±15x8,8



P PO 181/13 ⓘ
cm ±13x8,5,9



P PO 747/15
cm ±14,5x7,9



P PO 193/13 ⓘ
cm ±13x8,5,9,5



P PO 735/15
cm ±14,5x7,9



P PO 169/13 ⓘ
cm ±13x8,5,9,5



P PO 757/15
cm ±14,5x8,9



P PO 209/13 ⓘ
cm ±13x8,9,5



P PO 763/15
cm ±15x7,5,9



P PO 221/13 ⓘ
cm ±13,5x8,9,5

CINERARI E OSSARI

ACCIAIO INOX

cinerari
ed ossari

vases et
lampes pour
colombarium

accessories
for ossuaries

osarios

zubehör
für ossarium

PORTAORCHIDEA
CROMINOX



P 60 007/10
cm ±11x3,5,±4



P 60 009/10
cm ±11x3,5,±4

con anello dorato

PORTAORCHIDEA
ACCIAIO INOX FUSO



P 60 120/12 Ⓟ
cm ±14x4,5,±5

porta orchidea
acciaio inox fuso



P 66 171/12
cm ±12x8,±11

T 66 182/12
cm ±12x8,±ø6,5



P 60 152/13 Ⓟ
cm ±13x7,±7,5

T 60 163/14 Ⓟ
cm ±14x7,±ø4,5



P 66 034/12
cm ±12x7,5,±6,5

T 66 045/14
cm ±14x7,5,±ø5,5



P 60 037/13 Ⓟ
cm ±13x7,5,±6,5

T 60 048/14 Ⓟ
cm ±14x7,5,±ø5,5



P 66 012/12
cm ±12x7,5,±6,5

T 66 023/14
cm ±14x7,5,±ø5,5



P 60 015/13 Ⓟ
cm ±13x7,5,±6,5

T 60 026/14 Ⓟ
cm ±14x7,5,±ø5,5



P 66 101/15
cm ±14,5x6,5,±7



P 60 001/13 Ⓟ
cm ±13x7,±7,5



P 66 103/15
cm ±14,5x6,5,±7



P 60 003/13 Ⓟ
cm ±13x7,±7,5

CINERARI E OSSARI

CAGGIATI DESIGN



Collezione ANIMA
P 15 061
cm ±15,5x7,5,±5



Collezione RITORNO ALLA NATURA
P 15 021
cm ±19x20,±4,5



Collezione SOFFIO
P 15 031
cm ±16x27,±5
Acciaio BROWN
Microalumino a cupola compreso
Incisione compresa nel prezzo



Collezione TEMPO
P 15 041
cm ±15x28,±6,5
Acciaio BROWN
Incisione compresa
nel prezzo

CINERARI E OSSARI

CAGGIATI DESIGN

cinerari
ed ossari

vases et
lampes pour
colombarium

accessories
for ossuaries

oasarios

zubehör
für ossarium



Collezione CONTINUITÀ BIANCA

P 15 051
cm ±30,5x9,5



Collezione CONTINUITÀ BEIGE

P 15 052
cm ±30,5x9,5

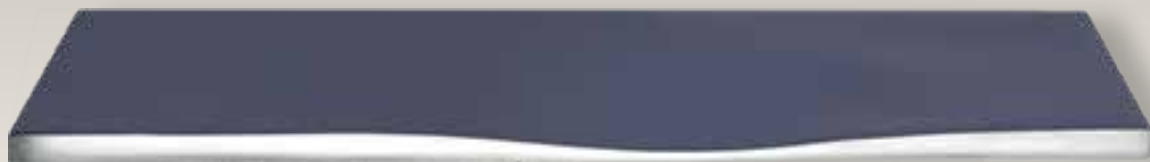

Collezione CONTINUITÀ BLU

P 15 053
cm ±30,5x9,5



UCCELLINO

P 73 025/03
Acciaio Inox

Esempio di applicazione



Destra



Sinistra

Nell'ordine specificare se versione destra o sinistra

URNE



URNE MOSAICO



urne
cinerarie

urnes
funeraires

urns

urnas
cinerarias

urnen

Finitura a Cera



"SPAZIO INVOLTO"

34 030/28
cm +28x35
Litri 6

urne
cinerarie

urnes
funeraires

urns

urnas
cinerarias

urnen



URNE MOSAICO

Finitura a Cera



"VELATA MADRE"

34 010/36
cm 436x338
Litri 6

URNE MOSAICO



urne
cinerarie

urnes
funeraires

urns

urnas
cinerarias

urnen

Finitura a Cera



"IN UN TRAMONTO"

34 040/39
cm :39x35
Litri 2

urne
cinerarie

urnes
funeraires

urns

urnas
cinerarias

urnen



URNE MOSAICO

Finitura a Cera

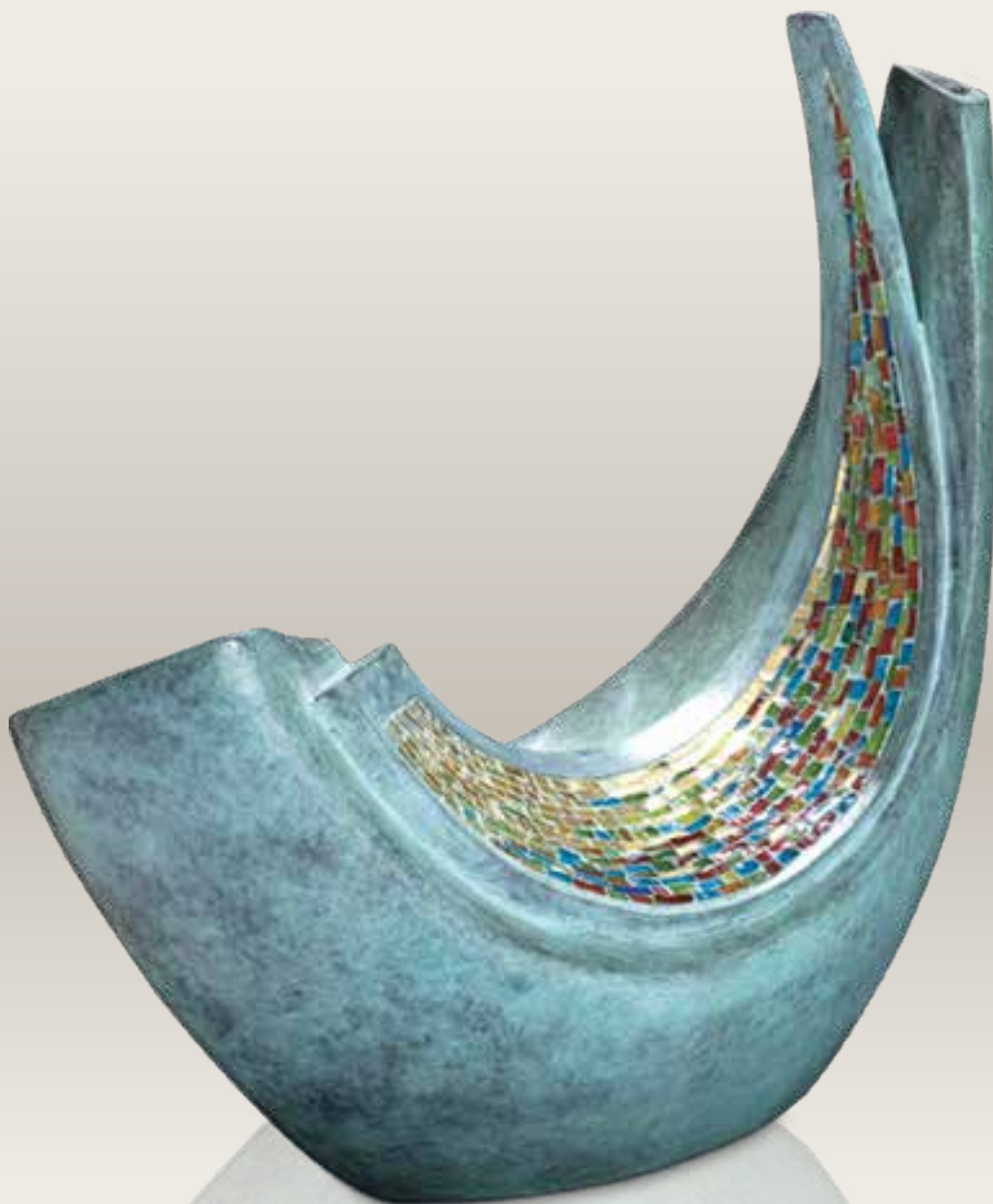

"EVANESCENTE PENSIERO"

34 020/39
cm : 39x45
Litri 2,5



URNE

CAGGIATI

DESIGN

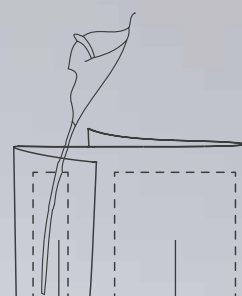

contenitore per i fiori

contenitore per le ceneri

URNA SOFFIO

39 160

cm 428x35,20,5

Litri 4

URNE

CAGGIATI DESIGN

urne
cinerarie

urnes
funeraires

urns

urnas
cinerarias

urnen



URNA ANIMA
39 190
cm ±20x22x±22
Litri 4



URNA CONTINUITÀ
39 180
cm ±23x23x±20
Litri 4

urne
cinerarie

urnes
funeraires

urns

urnas
cinerarias

urnen

URNE

CAGGIATI DESIGN



URNA RITORNO ALLA NATURA

39 150
cm ±18x20x±20
Litri 5,5



URNA TEMPO

39 170
cm ±22x23x±23
Litri 6,5

URNE CINERARIE



urne
cinerarie

urnes
funeraires

urns

urnas
cinerarias

urnen



39 050/26
cm :26x15,2x07
Litri 2,10



39 080/26
cm :26x15,2x07
Litri 2,10
Verde Pompeiano



39 001/26
cm :26,5x16,2x16
Litri 2,60



39 637/25
cm :26x22,2x20
Litri 4,50
Rame



39 663/25
cm :28x20,2x20
Litri 4,50
Rame



39 611/25
cm :25x20,2x20
Litri 4,50
Rame



39 684/25
cm :28x20,2x20
Litri 4,50
Rame



39 659/25
cm :25x20,2x20
Litri 4,50
Rame



39 823/25
cm :25x20,2x20
Litri 4,50
Alluminio

Blu

urne
cinerarie

urnes
funeraires

urns

urnas
cinerarias

urnen



URNE CINERARIE



39 667/32
cm ±32x14,±15,5
Litri 3,20



39 020/24
cm ±24x16,±15
Litri 3



39 100/28
cm ±28x16,±15
Litri 3,5



39 593/07
cm ±7x6,5
Litri 0,13



39 593/10
cm ±10x8,5
Litri 0,30



39 000/07
cm ±7x7,±6,5
Litri 0,10



39 410/06
cm ±6x6,±6x4
Mini urna



39 408/06
cm ±6x3,±ø3
Mini urna



39 709/25
cm ±24,5x17,5,±15
Litri 4



39 755/25
cm ±24,5x17,5,±15
Litri 4
Dark



39 764/25
cm ±24,5x17,5,±15
Litri 4
Uniblanco



39 268/24
cm ±23,8x12,4,±12,4
Litri 3,20

Applicazioni disponibili con biadesivo



24 215/15
cm ±15x7
Adesivo per urne



29 563/16
cm ±16x5
Adesivo per urne



32 578/105
cm ±11x8,5
Adesivo per urne



Esempio di applicazione
con biadesivo



22 042/70
cm ±7x10
Adesivo per urne

URNE CINERARIE



urne
cinerarie

urnes
funeraires

urns

urnas
cinerarias

urnen



39 607/27
cm +27x20,20
Litri 4,50
Rame



39 609/29
cm +29x20,20
Litri 4,50
Rame



39 603/29
cm +29x20,20
Litri 4,50
Rame



39 246/16
cm +15x24,5,9
Litri 2,60



39 202/21
cm +22x21,19
Litri 4

MEMORY

Per conservare il ricordo

Pour garder le souvenir

To keep the memory alive

Para conservar el recuerdo

Damit die erinnerung nicht vergeht

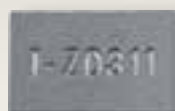

Identity disk
99 999/210
cm +5x3,4,5



99 940
cm +5,5x5,5



99 937/210
cm +5,5x5,5

urne
cinerarie

urnes
funeraires

urns

urnas
cinerarias

urnen



URNE MODULARI

SISTEMI MODULARI



I progetti ed i preventivi per le urne modulari sono realizzati su richiesta.

TERMANI

1947-2011

SOLO SI ALLONTANANO,
SARAI SEMPRE NEL
NOSTRO CUORE.



CRISTALLI DI LUCE



INFINITA È UN MARCHIO DI GARANZIA DI MATTHEWS INTERNATIONAL SPA

ECCELLENZA, PROTEZIONE,
DURATA, SICUREZZA, AMBIENTE

LIGHT CRYSTALS

CRISTALLI DI LUCE



C6060/10
cm 10x10

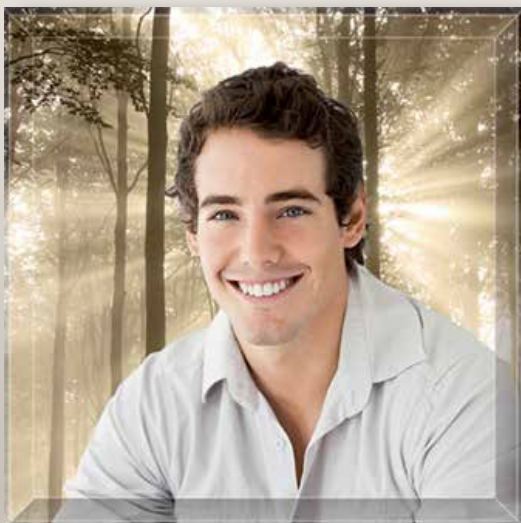

C6060/13
cm 13x13



C6060/15
cm 15x15

Sfogliando la sezione CRISTALLI DI LUCE, potrete scegliere lo sfondo più adatto alle vostre richieste.



DESIGN



C3011/40 40x30
C3011/36 36x27
C3011/32 32x24
C3011/28 28x21
C3011/24 24x18
C3011/20 20x15

C3012/40 40x21
C3012/36 36x19
C3012/32 32x17
C3012/28 28x15
C3012/24 24x13
C3012/20 20x10,5

C3013/40 40x16
C3013/35 35x14
C3013/30 30x12
C3013/25 25x10



C3014/16 16x40
C3014/14 14x35
C3014/12 12x30
C3014/10 10x25

Carattere consigliato CENTURY
(abaco caratteri a pag. 599)



Le versioni **speculari** e le versioni a **due soggetti** sono disponibili su richiesta



C3021/40 40x30
C3021/36 36x27
C3021/32 32x24
C3021/28 28x21
C3021/24 24x18
C3021/20 20x15

C3022/40 40x21
C3022/36 36x19
C3022/32 32x17
C3022/28 28x15
C3022/24 24x13
C3022/20 20x10,5

C3023/40 40x16
C3023/35 35x14
C3023/30 30x12
C3023/25 25x10



C3024/16 16x40
C3024/14 14x35
C3024/12 12x30
C3024/10 10x25

Carattere consigliato ROMANO
(abaco caratteri a pag. 599)



Le versioni **speculari** e le versioni a **due soggetti** sono disponibili su richiesta

CRISTALLI DI LUCE DESIGN

LIGHT CRYSTALS



C3031/40 40x30
C3031/36 36x27
C3031/32 32x24
C3031/28 28x21
C3031/24 24x18
C3031/20 20x15

C3032/40 40x21
C3032/36 36x19
C3032/32 32x17
C3032/28 28x15
C3032/24 24x13
C3032/20 20x10,5

C3033/40 40x16
C3033/35 35x14
C3033/30 30x12
C3033/25 25x10



C3034/16 16x40
C3034/14 14x35
C3034/12 12x30
C3034/10 10x25

Carattere consigliato CENTURY
(abaco caratteri a pag. 599)



Le versioni **speculari** e le versioni a **due soggetti** sono disponibili su richiesta



C3511/40 40x30
C3511/36 36x27
C3511/32 32x24
C3511/28 28x21
C3511/24 24x18
C3511/20 20x15

C3512/40 40x21
C3512/36 36x19
C3512/32 32x17
C3512/28 28x15
C3512/24 24x13
C3512/20 20x10,5

C3513/40 40x16
C3513/35 35x14
C3513/30 30x12
C3513/25 25x10



C3514/16 16x40
C3514/14 14x35
C3514/12 12x30
C3514/10 10x25

Carattere consigliato HELVETICA
(abaco caratteri a pag. 599)



Le versioni **speculari** e le versioni a **due soggetti** sono disponibili su richiesta



C3521/40 40x30
C3521/36 36x27
C3521/32 32x24
C3521/28 28x21
C3521/24 24x18
C3521/20 20x15

C3522/40 40x21
C3522/36 36x19
C3522/32 32x17
C3522/28 28x15
C3522/24 24x13
C3522/20 20x10,5

C3523/40 40x16
C3523/35 35x14
C3523/30 30x12
C3523/25 25x10



C3524/16 16x40
C3524/14 14x35
C3524/12 12x30
C3524/10 10x25

Carattere consigliato HELVETICA
(abaco caratteri a pag. 599)



Le versioni **speculari** e le versioni a **due soggetti** sono disponibili su richiesta



C3531/40 40x30
C3531/36 36x27
C3531/32 32x24
C3531/28 28x21
C3531/24 24x18
C3531/20 20x15

C3532/40 40x21
C3532/36 36x19
C3532/32 32x17
C3532/28 28x15
C3532/24 24x13
C3532/20 20x10,5

C3533/40 40x16
C3533/35 35x14
C3533/30 30x12
C3533/25 25x10



C3534/16 16x40
C3534/14 14x35
C3534/12 12x30
C3534/10 10x25

Carattere consigliato HELVETICA
(abaco caratteri a pag. 599)



Le versioni **speculari** e le versioni a **due soggetti** sono disponibili su richiesta



FLOREALI



C1011/40 40x30
C1011/36 36x27
C1011/32 32x24
C1011/28 28x21
C1011/24 24x18
C1011/20 20x15

C1012/40 40x21
C1012/36 36x19
C1012/32 32x17
C1012/28 28x15
C1012/24 24x13
C1012/20 20x10,5

C1013/40 40x16
C1013/35 35x14
C1013/30 30x12
C1013/25 25x10



C1014/16 16x40
C1014/14 14x35
C1014/12 12x30
C1014/10 10x25

Carattere consigliato **BODONI**
(abaco caratteri a pag. 599)



Le versioni **speculari** e le versioni a **due soggetti** sono disponibili su richiesta



C1031/40 40x30
C1031/36 36x27
C1031/32 32x24
C1031/28 28x21
C1031/24 24x18
C1031/20 20x15

C1032/40 40x21
C1032/36 36x19
C1032/32 32x17
C1032/28 28x15
C1032/24 24x13
C1032/20 20x10,5

C1033/40 40x16
C1033/35 35x14
C1033/30 30x12
C1033/25 25x10



C1034/16 16x40
C1034/14 14x35
C1034/12 12x30
C1034/10 10x25

Carattere consigliato **CENTURY**
(abaco caratteri a pag. 599)



Le versioni **speculari** e le versioni a **due soggetti** sono disponibili su richiesta

CRISTALLI DI LUCE FLOREALI

LIGHT CRYSTALS



C1021/40 40x30
C1021/36 36x27
C1021/32 32x24
C1021/28 28x21
C1021/24 24x18
C1021/20 20x15

C1022/40 40x21
C1022/36 36x19
C1022/32 32x17
C1022/28 28x15
C1022/24 24x13
C1022/20 20x10,5

C1023/40 40x16
C1023/35 35x14
C1023/30 30x12
C1023/25 25x10

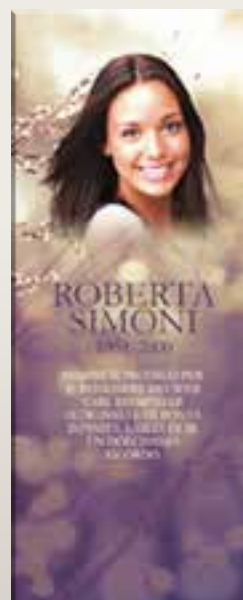

C1024/16 16x40
C1024/14 14x35
C1024/12 12x30
C1024/10 10x25

Carattere consigliato ROMANO
(abaco caratteri a pag. 599)



Le versioni **speculari** e le versioni a **due soggetti** sono disponibili su richiesta



C1041/40 40x30
C1041/36 36x27
C1041/32 32x24
C1041/28 28x21
C1041/24 24x18
C1041/20 20x15

C1042/40 40x21
C1042/36 36x19
C1042/32 32x17
C1042/28 28x15
C1042/24 24x13
C1042/20 20x10,5

C1043/40 40x16
C1043/35 35x14
C1043/30 30x12
C1043/25 25x10



C1044/16 16x40
C1044/14 14x35
C1044/12 12x30
C1044/10 10x25

Carattere consigliato CENTURY
(abaco caratteri a pag. 599)



Le versioni **speculari** e le versioni a **due soggetti** sono disponibili su richiesta



C1511/40 40x30
C1511/36 36x27
C1511/32 32x24
C1511/28 28x21
C1511/24 24x18
C1511/20 20x15

C1512/40 40x21
C1512/36 36x19
C1512/32 32x17
C1512/28 28x15
C1512/24 24x13
C1512/20 20x10,5

C1513/40 40x16
C1513/35 35x14
C1513/30 30x12
C1513/25 25x10



C1514/16 16x40
C1514/14 14x35
C1514/12 12x30
C1514/10 10x25

Carattere consigliato **BASTONE**
(abaco caratteri a pag. 599)



Le versioni **speculari** e le versioni a **due soggetti** sono disponibili su richiesta



C1521/40 40x30
C1521/36 36x27
C1521/32 32x24
C1521/28 28x21
C1521/24 24x18
C1521/20 20x15

C1522/40 40x21
C1522/36 36x19
C1522/32 32x17
C1522/28 28x15
C1522/24 24x13
C1522/20 20x10,5

C1523/40 40x16
C1523/35 35x14
C1523/30 30x12
C1523/25 25x10



C1524/16 16x40
C1524/14 14x35
C1524/12 12x30
C1524/10 10x25

Carattere consigliato **BASTONE**
(abaco caratteri a pag. 599)



Le versioni **speculari** e le versioni a **due soggetti** sono disponibili su richiesta

CRISTALLI DI LUCE FLOREALI

LIGHT CRYSTALS



C1531/40 40x30
C1531/36 36x27
C1531/32 32x24
C1531/28 28x21
C1531/24 24x18
C1531/20 20x15

C1532/40 40x21
C1532/36 36x19
C1532/32 32x17
C1532/28 28x15
C1532/24 24x13
C1532/20 20x10,5

C1533/40 40x16
C1533/35 35x14
C1533/30 30x12
C1533/25 25x10



C1534/16 16x40
C1534/14 14x35
C1534/12 12x30
C1534/10 10x25

Carattere consigliato **IMPACT**
(abaco caratteri a pag. 599)



Le versioni **speculari** e le versioni a **due soggetti** sono disponibili su richiesta



C1541/40 40x30
C1541/36 36x27
C1541/32 32x24
C1541/28 28x21
C1541/24 24x18
C1541/20 20x15

C1542/40 40x21
C1542/36 36x19
C1542/32 32x17
C1542/28 28x15
C1542/24 24x13
C1542/20 20x10,5

C1543/40 40x16
C1543/35 35x14
C1543/30 30x12
C1543/25 25x10



C1544/16 16x40
C1544/14 14x35
C1544/12 12x30
C1544/10 10x25

Carattere consigliato **CENTURY**
(abaco caratteri a pag. 599)



Le versioni **speculari** e le versioni a **due soggetti** sono disponibili su richiesta

LIGHT CRYSTALS

CRISTALLI DI LUCE
FLOREALI



SOGGETTI
Esempi
di abbinamento
sfondi

ROSA



CALLA



ORCHIDEA



SFONDI

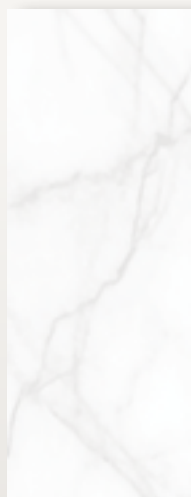

DIMENSIONI

- C7000/19** 51x19
- C7004/16** 40x16
- C7005/19** 36x19
- C7005/10** 20x10,5

MAGGIORAZIONI

LAVORAZIONE BISELLATA
SOGGETTI E SFONDI DIVERSI



Esempio di cristallo bisellato

PAESAGGI





C2011/40 40x30
C2011/36 36x27
C2011/32 32x24
C2011/28 28x21
C2011/24 24x18
C2011/20 20x15

C2012/40 40x21
C2012/36 36x19
C2012/32 32x17
C2012/28 28x15
C2012/24 24x13
C2012/20 20x10,5

C2013/40 40x16
C2013/35 35x14
C2013/30 30x12
C2013/25 25x10



Le versioni **speculari** e le versioni a **due soggetti** sono disponibili su richiesta



C2014/16 16x40
C2014/14 14x35
C2014/12 12x30
C2014/10 10x25

Carattere consigliato CENTURY (abaco caratteri a pag. 599)



C2021/40 40x30
C2021/36 36x27
C2021/32 32x24
C2021/28 28x21
C2021/24 24x18
C2021/20 20x15

C2022/40 40x21
C2022/36 36x19
C2022/32 32x17
C2022/28 28x15
C2022/24 24x13
C2022/20 20x10,5

C2023/40 40x16
C2023/35 35x14
C2023/30 30x12
C2023/25 25x10



Le versioni **speculari** e le versioni a **due soggetti** sono disponibili su richiesta



C2024/16 16x40
C2024/14 14x35
C2024/12 12x30
C2024/10 10x25

Carattere consigliato Nimbus e CENTURY (abaco caratteri a pag. 599)

CRISTALLI DI LUCE

PAESAGGI

LIGHT CRYSTALS



C2031/40 40x30
C2031/36 36x27
C2031/32 32x24
C2031/28 28x21
C2031/24 24x18
C2031/20 20x15

C2032/40 40x21
C2032/36 36x19
C2032/32 32x17
C2032/28 28x15
C2032/24 24x13
C2032/20 20x10,5

C2033/40 40x16
C2033/35 35x14
C2033/30 30x12
C2033/25 25x10

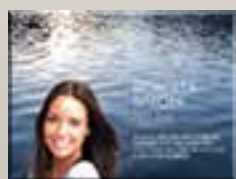

Le versioni **speculari** e le versioni a **due soggetti** sono disponibili su richiesta



C2034/16 16x40
C2034/14 14x35
C2034/12 12x30
C2034/10 10x25

Carattere consigliato CENTURY (abaco caratteri a pag. 599)



C2041/40 40x30
C2041/36 36x27
C2041/32 32x24
C2041/28 28x21
C2041/24 24x18
C2041/20 20x15

C2042/40 40x21
C2042/36 36x19
C2042/32 32x17
C2042/28 28x15
C2042/24 24x13
C2042/20 20x10,5

C2043/40 40x16
C2043/35 35x14
C2043/30 30x12
C2043/25 25x10



Le versioni **speculari** e le versioni a **due soggetti** sono disponibili su richiesta



C2044/16 16x40
C2044/14 14x35
C2044/12 12x30
C2044/10 10x25

Carattere consigliato CENTURY (abaco caratteri a pag. 599)



C2511/40 40x30
C2511/36 36x27
C2511/32 32x24
C2511/28 28x21
C2511/24 24x18
C2511/20 20x15

C2512/40 40x21
C2512/36 36x19
C2512/32 32x17
C2512/28 28x15
C2512/24 24x13
C2512/20 20x10,5

C2513/40 40x16
C2513/35 35x14
C2513/30 30x12
C2513/25 25x10



C2514/16 16x40
C2514/14 14x35
C2514/12 12x30
C2514/10 10x25

Carattere consigliato ROMANO
(abaco caratteri a pag. 599)



Le versioni **speculari** e le versioni a **due soggetti** sono disponibili su richiesta



C2521/40 40x30
C2521/36 36x27
C2521/32 32x24
C2521/28 28x21
C2521/24 24x18
C2521/20 20x15

C2522/40 40x21
C2522/36 36x19
C2522/32 32x17
C2522/28 28x15
C2522/24 24x13
C2522/20 20x10,5

C2523/40 40x16
C2523/35 35x14
C2523/30 30x12
C2523/25 25x10



C2524/16 16x40
C2524/14 14x35
C2524/12 12x30
C2524/10 10x25

Carattere consigliato **IMPACT**
(abaco caratteri a pag. 599)



Le versioni **speculari** e le versioni a **due soggetti** sono disponibili su richiesta

CRISTALLI DI LUCE

PAESAGGI

LIGHT CRYSTALS



C2531/40 40x30
C2531/36 36x27
C2531/32 32x24
C2531/28 28x21
C2531/24 24x18
C2531/20 20x15

C2532/40 40x21
C2532/36 36x19
C2532/32 32x17
C2532/28 28x15
C2532/24 24x13
C2532/20 20x10,5

C2533/40 40x16
C2533/35 35x14
C2533/30 30x12
C2533/25 25x10



C2534/16 16x40
C2534/14 14x35
C2534/12 12x30
C2534/10 10x25

Carattere consigliato **BODONI**
 (abaco caratteri a pag. 599)



Le versioni **speculari** e le versioni a **due soggetti** sono disponibili su richiesta



C2541/40 40x30
C2541/36 36x27
C2541/32 32x24
C2541/28 28x21
C2541/24 24x18
C2541/20 20x15

C2542/40 40x21
C2542/36 36x19
C2542/32 32x17
C2542/28 28x15
C2542/24 24x13
C2542/20 20x10,5

C2543/40 40x16
C2543/35 35x14
C2543/30 30x12
C2543/25 25x10



C2544/16 16x40
C2544/14 14x35
C2544/12 12x30
C2544/10 10x25

Carattere consigliato **ROMANO**
 (abaco caratteri a pag. 599)



Le versioni **speculari** e le versioni a **due soggetti** sono disponibili su richiesta

LIGHT CRYSTALS

CRISTALLI DI LUCE
PAESAGGI





EMOZIONALI



C5011/40 40x30
C5011/36 36x27
C5011/32 32x24
C5011/28 28x21
C5011/24 24x18
C5011/20 20x15

C5012/40 40x21
C5012/36 36x19
C5012/32 32x17
C5012/28 28x15
C5012/24 24x13
C5012/20 20x10,5

C5013/40 40x16
C5013/35 35x14
C5013/30 30x12
C5013/25 25x10

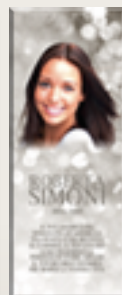
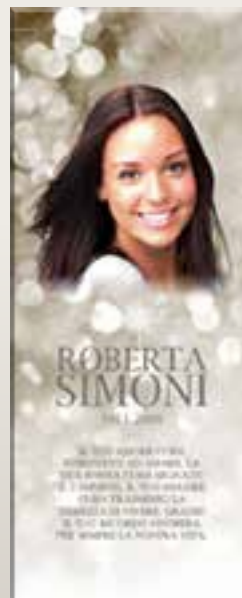

C5014/16 16x40
C5014/14 14x35
C5014/12 12x30
C5014/10 10x25

Carattere consigliato **BODONI**
(abaco caratteri a pag. 599)



Le versioni **speculari** e le versioni a **due soggetti** sono disponibili su richiesta



C5021/40 40x30
C5021/36 36x27
C5021/32 32x24
C5021/28 28x21
C5021/24 24x18
C5021/20 20x15

C5022/40 40x21
C5022/36 36x19
C5022/32 32x17
C5022/28 28x15
C5022/24 24x13
C5022/20 20x10,5

C5023/40 40x16
C5023/35 35x14
C5023/30 30x12
C5023/25 25x10



C5024/16 16x40
C5024/14 14x35
C5024/12 12x30
C5024/10 10x25

Carattere consigliato **COMPATTO**
(abaco caratteri a pag. 599)



Le versioni **speculari** e le versioni a **due soggetti** sono disponibili su richiesta

CRISTALLI DI LUCE

EMOZIONALI

LIGHT CRYSTALS



C5511/40 40x30
C5511/36 36x27
C5511/32 32x24
C5511/28 28x21
C5511/24 24x18
C5511/20 20x15

C5512/40 40x21
C5512/36 36x19
C5512/32 32x17
C5512/28 28x15
C5512/24 24x13
C5512/20 20x10,5

C5513/40 40x16
C5513/35 35x14
C5513/30 30x12
C5513/25 25x10



C5514/16 16x40
C5514/14 14x35
C5514/12 12x30
C5514/10 10x25

Carattere consigliato **BODONI**
 (abaco caratteri a pag. 599)



Le versioni **speculari** e le versioni a **due soggetti** sono disponibili su richiesta



C5521/40 40x30
C5521/36 36x27
C5521/32 32x24
C5521/28 28x21
C5521/24 24x18
C5521/20 20x15

C5522/40 40x21
C5522/36 36x19
C5522/32 32x17
C5522/28 28x15
C5522/24 24x13
C5522/20 20x10,5

C5523/40 40x16
C5523/35 35x14
C5523/30 30x12
C5523/25 25x10



C5524/16 16x40
C5524/14 14x35
C5524/12 12x30
C5524/10 10x25

Carattere consigliato **BASTONE**
 (abaco caratteri a pag. 599)



Le versioni **speculari** e le versioni a **due soggetti** sono disponibili su richiesta

LIGHT CRYSTALS

CRISTALLI DI LUCE
EMOZIONALI



A black and white photograph of a classical statue, likely a female figure, shown from the chest up. The statue is positioned on the right side of the frame, with its head tilted slightly to the left. The lighting is dramatic, highlighting the contours of the face and the folds of the garment. The background is a bright, out-of-focus landscape with bare trees. The word "STATUARIE" is overlaid in a clean, sans-serif font on the left side of the image.

STATUARIE



C4011/40 40x30
C4011/36 36x27
C4011/32 32x24
C4011/28 28x21
C4011/24 24x18
C4011/20 20x15

C4012/40 40x21
C4012/36 36x19
C4012/32 32x17
C4012/28 28x15
C4012/24 24x13
C4012/20 20x10,5

C4013/40 40x16
C4013/35 35x14
C4013/30 30x12
C4013/25 25x10



C4014/16 16x40
C4014/14 14x35
C4014/12 12x30
C4014/10 10x25



Le versioni **speculari** e le versioni a **due soggetti** sono disponibili su richiesta

Carattere consigliato *Corina* e CENTURY (abaco caratteri a pag. 599)



C4021/40 40x30
C4021/36 36x27
C4021/32 32x24
C4021/28 28x21
C4021/24 24x18
C4021/20 20x15

C4022/40 40x21
C4022/36 36x19
C4022/32 32x17
C4022/28 28x15
C4022/24 24x13
C4022/20 20x10,5

C4023/40 40x16
C4023/35 35x14
C4023/30 30x12
C4023/25 25x10



C4024/16 16x40
C4024/14 14x35
C4024/12 12x30
C4024/10 10x25



Le versioni **speculari** e le versioni a **due soggetti** sono disponibili su richiesta

Carattere consigliato **BODONI** (abaco caratteri a pag. 599)

CRISTALLI DI LUCE STATUARIE

LIGHT CRYSTALS



C4031/40 40x30
C4031/36 36x27
C4031/32 32x24
C4031/28 28x21
C4031/24 24x18
C4031/20 20x15

C4032/40 40x21
C4032/36 36x19
C4032/32 32x17
C4032/28 28x15
C4032/24 24x13
C4032/20 20x10,5

C4033/40 40x16
C4033/35 35x14
C4033/30 30x12
C4033/25 25x10



C4034/16 16x40
C4034/14 14x35
C4034/12 12x30
C4034/10 10x25



Le versioni **speculari** e le versioni a **due soggetti** sono disponibili su richiesta

Carattere consigliato ROMANO
(abaco caratteri a pag. 599)



C4041/40 40x30
C4041/36 36x27
C4041/32 32x24
C4041/28 28x21
C4041/24 24x18
C4041/20 20x15

C4042/40 40x21
C4042/36 36x19
C4042/32 32x17
C4042/28 28x15
C4042/24 24x13
C4042/20 20x10,5

C4043/40 40x16
C4043/35 35x14
C4043/30 30x12
C4043/25 25x10



C4044/16 16x40
C4044/14 14x35
C4044/12 12x30
C4044/10 10x25



Le versioni **speculari** e le versioni a **due soggetti** sono disponibili su richiesta

Carattere consigliato CENTURY
(abaco caratteri a pag. 599)



C4051/40 40x30
C4051/36 36x27
C4051/32 32x24
C4051/28 28x21
C4051/24 24x18
C4051/20 20x15

C4052/40 40x21
C4052/36 36x19
C4052/32 32x17
C4052/28 28x15
C4052/24 24x13
C4052/20 20x10,5

C4053/40 40x16
C4053/35 35x14
C4053/30 30x12
C4053/25 25x10



C4054/16 16x40
C4054/14 14x35
C4054/12 12x30
C4054/10 10x25

Carattere consigliato *Nimbus* e CENTURY (abaco caratteri a pag. 599)



Le versioni **speculari** e le versioni a **due soggetti** sono disponibili su richiesta



C4511/40 40x30
C4511/36 36x27
C4511/32 32x24
C4511/28 28x21
C4511/24 24x18
C4511/20 20x15

C4512/40 40x21
C4512/36 36x19
C4512/32 32x17
C4512/28 28x15
C4512/24 24x13
C4512/20 20x10,5

C4513/40 40x16
C4513/35 35x14
C4513/30 30x12
C4513/25 25x10



C4514/16 16x40
C4514/14 14x35
C4514/12 12x30
C4514/10 10x25

Carattere consigliato **NEW YORK** (abaco caratteri a pag. 599)



Le versioni **speculari** e le versioni a **due soggetti** sono disponibili su richiesta

CRISTALLI DI LUCE

STATUARIE

LIGHT CRYSTALS



C4521/40 40x30
C4521/36 36x27
C4521/32 32x24
C4521/28 28x21
C4521/24 24x18
C4521/20 20x15

C4522/40 40x21
C4522/36 36x19
C4522/32 32x17
C4522/28 28x15
C4522/24 24x13
C4522/20 20x10,5

C4523/40 40x16
C4523/35 35x14
C4523/30 30x12
C4523/25 25x10



C4524/16 16x40
C4514/14 14x35
C4524/12 12x30
C4524/10 10x25

Carattere consigliato CENTURY
 (abaco caratteri a pag. 599)



Le versioni **speculari** e le versioni a **due soggetti** sono disponibili su richiesta



C4531/40 40x30
C4531/36 36x27
C4531/32 32x24
C4531/28 28x21
C4531/24 24x18
C4531/20 20x15

C4532/40 40x21
C4532/36 36x19
C4532/32 32x17
C4532/28 28x15
C4532/24 24x13
C4532/20 20x10,5

C4533/40 40x16
C4533/35 35x14
C4533/30 30x12
C4533/25 25x10



C4534/16 16x40
C4534/14 14x35
C4534/12 12x30
C4534/10 10x25

Carattere consigliato BASTONE
 (abaco caratteri a pag. 599)



Le versioni **speculari** e le versioni a **due soggetti** sono disponibili su richiesta



C4541/40 40x30
C4541/36 36x27
C4541/32 32x24
C4541/28 28x21
C4541/24 24x18
C4541/20 20x15

C4542/40 40x21
C4542/36 36x19
C4542/32 32x17
C4542/28 28x15
C4542/24 24x13
C4542/20 20x10,5

C4543/40 40x16
C4543/35 35x14
C4543/30 30x12
C4543/25 25x10



C4544/16 16x40
C4544/14 14x35
C4544/12 12x30
C4544/10 10x25

Carattere consigliato **BASTONE**
(abaco caratteri a pag. 599)



Le versioni **speculari** e le versioni a **due soggetti** sono disponibili su richiesta

PIEDISTALLI PER CRISTALLI DI LUCE



95 071/0
cm :8x2
Bronzo



95 097/0
cm :8x2
Beige



95 089/0
cm :8x2
Unibianco

Esempio di applicazione



MAGGIORAZIONI CRISTALLI DI LUCE

- ELABORAZIONE DI SFONDI E IMPOSTAZIONI SPECIALI SUL PREZZO DI LISTINO
- IL FILE ESECUTIVO FORNITO DAL CLIENTE NON COMPORTA NESSUN ADDEBITO AGGIUNTIVO

Gli angoli di tutti i cristalli, se non specificatamente richiesto dal cliente, saranno realizzati stondati di 5° in modo da agevolare la predisposizione dell'incasso sul marmo.



CRISTALLI DI LUCE
TECNOLOGIA

LIGHT CRYSTALS
TECHNOLOGY

Il prodotto è ottenuto mediante un innovativo processo di nano-pigmentazione. Questa tecnologia permette al decoro di avere un'adesione perfetta al supporto di vetro sul quale viene stampato.

I colori, a differenza delle altre tecniche attualmente sul mercato, si presentano molto brillanti. Un gamut di colori molto vasto e dettagliato permette pertanto di ottenere la massima fedeltà alle fotografie originali.

Il prodotto deve essere fissato al marmo mediante utilizzo di collante non siliconico che garantisca eccellente tenuta anche in presenza di acqua e umidità.

In abbinamento a ciascun Cristallo di Luce, verrà fornito un kit di montaggio meccanico per una maggiore sicurezza.

La stratificazione del prodotto è una sicura garanzia di resistenza a tutte le condizioni ambientali, comprese quelle salmastre. Un ulteriore filtro protettivo garantisce una lunga durata del colore.

L'utilizzo della tecnica di stratificazione con interposizione di prodotti specifici garantisce l'infrangibilità del Cristallo di Luce. In caso di urto violento di oggetti o di caduta, il prodotto non si frantuma.



The product is obtained by means of an innovative process of nano-pigmentation. This technology allows the decoration to adhere perfectly to the glass support on which it is printed. The colours are extremely bright, unlike every other techniques currently on the market. A very extensive and detailed gamut of colors ensures the highest fidelity to the original photographs.

The product must be secured to the marble with a non siliconic adhesive, so that it guarantees an excellent grip when exposed to water and umidity.

Each Light Crystal comes complete with a mechanical installation kit for added security.

The layering of the product is a sure guarantee of resistance to all environmental conditions, including sea air. An additional protective filter ensures long-lasting colour.

Thanks to the use of the layering technique with interplacement of specific products, Light Crystals is unbreakable. The pproduct will shatter if dropped or subjected to violent collision.



"INFINITA" È UN MARCHIO DI GARANZIA DI MATTHEWS INTERNATIONAL SPA.

ECCELLENZA, PROTEZIONE,
DURATA, SICUREZZA, AMBIENTE

ABACO
CARATTERI
DEDICHE
ABITI

ABACUS
FONTS
DEDICATIONS
CLOTHING

LIGHT CRYSTALS
FONTS

CRISTALLI DI LUCE
CARATTERI

ROMANO

GARAMOND

BODONI

LUCIDA BRIGHT

NEW YORK

HELVETICA NEUE MEDIUM

COMPATTO

HELVETICA NEUE LTD STD THIN CONDENSED

BASTONE

HELVETICA NEUE MEDIUM COND

HELVETICA

HELVETICA NEUE LIGHT

IMPACT

IMPACT

CENTURY

CENTURY GOTHIC

Nimbus

NIMBUS SCRIPT

Corsivo

EDWARDIAN SCRIPT ITC

CRISTALLI DI LUCE

DEDICHE

LIGHT CRYSTALS

DEDICATIONS

1. I tuoi cari a ricordo.
2. Amarti è stato facile dimenticarti impossibile.
3. Sarai sempre nel cuore di chi ti ama.
4. Sarai sempre nei nostri cuori
5. Tu sei ogni giorno nei nostri pensieri.
6. Il tuo ricordo vive nei nostri cuori.
7. Ti ameremo sempre.
8. Ti ricorderemo sempre.
9. In ricordo dei bei momenti passati insieme.
10. Sarai sempre con noi.
11. Voglio ricordarti com'eri, pensare che ancora vivi, che come allora mi ascolti e ancora sorridi.
12. Le persone come te non muoiono per sempre, solo si allontanano. Sarai sempre nel nostro cuore.
13. Miei cari non guardate la vita che lascio, ma quella che incomincia.
14. Mancherai tanto a tutti noi, ma resterai sempre vivo nei nostri ricordi.
15. Riposa nella pace dei giusti, rivivi nella luce di Dio.
16. Vivrai sempre nelle nostre preghiere.
17. Il Signore è il mio pastore: non manco di nulla, su pascoli erbosi mi fa riposare, ad acque tranquille mi conduce.
18. Hai mutato il mio lamento in danza, la mia veste di sacco in abito di gioia, perché io possa cantare senza posa. Signore, mio Dio, ti loderò per sempre.
19. Non piangete la mia assenza sono beato/a in Dio e prego per voi.
20. Laudata sii per la tua morte, o sera, e per l'attesa che in te fa palpitare le prime stelle. (G. D'Annunzio)
21. Non siate tristi per me, ricordatemi con un sorriso, sarò sempre con voi.
22. Il tuo amore ci ha insegnato ad amare, la tua bontà ci ha segnato il cammino, il tuo dolore ci ha trasmesso la fierezza di vivere. Grazie! Il tuo ricordo onorerà per sempre la nostra vita.
23. Non piangete la mia assenza, sentitemi vicina/o e parlatemi ancora io vi amerò dal cielo come vi ho amato in terra.
24. Io sono la Resurrezione e la Vita, chi ha fede in me anche se muore vivrà.
25. La tua morte inattesa e rapida lascia un gran vuoto fra tutti coloro che ti amarono. Nel loro animo sarà sempre vivo il tuo ricordo.
26. "Non si perdono mai coloro che amiamo, perché possiamo amarli in Colui che non si può perdere".
27. "Le anime dei giusti sono fra le braccia di Dio".
28. "Consolatevi con me, voi tutti che mi eravate tanto cari. Io lascio un mondo di dolore per un Regno di pace". (S. Caterina da Siena)
29. Colui che piangiamo non è assente ma soltanto invisibile, i suoi occhi raggianti di gloria stanno fissi nei nostri pieni di lacrime. (S. Agostino)
30. "Non l'abbiamo perduto egli dimora prima di noi nella luce di Dio".
31. Riposa nella pace dei giusti rivive nella luce di Dio.

LIGHT CRYSTALS DEDICATIONS

32. L'eterno riposo dona a lui/lei, o Signore, e splenda ad esso/a la luce perpetua. Riposa in pace.

33. A tutti coloro che lo/a conobbero e l'amarono perché rimanga vivo il suo ricordo.

34. Buono, onesto ed operoso, amato e stimato da tutti, lascia sulla terra le tracce luminose delle sue elette virtù. I suoi cari a ricordo

35. Dal regno della pace e della serenità il Signore ti ha chiamato. Veglia sui tuoi cari che a te pensano sempre.

36. L'onestà fu il suo ideale, il lavoro la sua vita, la famiglia il suo affetto. I suoi cari ne serbano nel cuore la memoria.

37. Non piangete sarò l'angelo invisibile della famiglia. Dio non saprà negarmi niente quando lo pregherò per voi. (S. Agostino)

38. "Una lacrima per i defunti evapora. Un fiore sulla loro tomba appassisce. Una preghiera per la loro anima la raccoglie Iddio" (S. Agostino)

39. Serenamente si addormentò nel Signore dopo una vita interamente dedicata alla famiglia e al lavoro. Moglie e madre esemplare lascia al marito e ai figli una eredità di fede e di amore.

40. "La sua morte lascia nel nostro cuore una piaga profonda. Noi ti abbiamo supplicato o Signore, di prolungare i suoi giorni, Tu gli/le hai dato il riposo eterno. Il Tuo Santo Nome sia benedetto ..."

41. Il Signore volga a te il suo sguardo, ti benedica, ti doni pace.

42. Io vi amerò dal Cielo come vi ho amato sulla terra.

43. Sempre si prodigò per il benessere dei suoi cari. Esempio di altruismo e di bontà infinita. Lascia di sé un dolcissimo ricordo.

CRISTALLI DI LUCE DEDICHE

44. Resterai sempre nel cuore di quanti ti vollero bene.

45. Raro esempio di bontà d'animo semplice e di nobili sentimenti, dedicò la sua vita alla famiglia che tanto amava.

46. Perché rimanga vivo nella memoria di chi lo conobbe e ne apprezzò l'animo generoso e buono.

47. Sopravviva la sua immagine nella memoria di quanti l'ebbero cara/o.

48. Le anime dei buoni sono fra le braccia di Dio.

49. Il giusto non muore, ma vive in eterno nella pace di Dio e nel ricordo di chi l'ha conosciuto e amato.

50. Ebbe da Dio il dono di una immensa bontà. Tutta la sua vita spese interamente per la famiglia.

51. L'assenza non è assenza, abbiate fede, colei/colui che non vedete è con voi. (S. Agostino)

52. Nessuno muore sulla terra finché vive nel cuore di chi resta.

ACCESSORI



SOFT CANDLE



95 036/0 Media
cm ±12,5 ø7,5



95 049/0 Piccola
cm ±11,5 ø5,3



95 038/0 Mini
cm ±9 ø4,2

ACCESSORI



95 024/0 Grande
cm :16,5 ø8,5

MICROLUMINO UNIVERSALE

Forte luce intermittente a lunga durata con batteria "stilo" da 1,5 v. con adattatore per fiamma da ø 5 cm

Petite Bougie Universelle, Intense Lumière intermittente longue durée, batterie de 1,5 V avec adaptateur flamme ø 5 cm.

Universal Small Battery Powered Candles, High Intermittent light long length with 1,5 V battery with adaptor for ø 5 cm. flame.

Micromariposa Universal con Fuerte Luz Intermitente de larga duración y batería de 1,5 V, con adaptador para llamas ø 5 cm.

Klein Gesamtbatteriebetriebene Mit Stark Blinklicht Lang dauern mit Akku 1,5 V mit Anpassung für ø 5 cm. Flamme



95 006/0
95 069/0

Cupolino rosso
Cupolino trasparente

95 008/10

MICROLUMINO A CUPOLA

FORTE LUCE INTERMITTENTE A LUNGA DURATA CON BATTERIA "STILO" DA 1,5 V.

Petite Bougie à Coupole, Intense Lumière intermittente à longue durée avec batterie de 1,5 V.

Votive Light With Globe Flickering light long-life operates with a replaceable 1,5 volt battery (aa).

Micromariposa Con Base potente luz intermitente de larga duración, con pila de 1,5 v (aa).

Kleines Universallichter mit Kupperartigem Schutz starkes bleibendes blinklicht mit normaler batterie von 1,5 volt (aa).



95 010/0

RAINBOW

I COLORI DELL'ARCOBALENO



95 105/0
95 103/0
95 106/0
95 104/0
95 107/0

Lampadina "Rainbow" Blu
Lampadina "Rainbow" Verde
Lampadina "Rainbow" Multicolor
Lampadina "Rainbow" Rossa
Lampadina "Rainbow" Bianca

LUMINO A LUCE INTERMITTENTE LUNGA DURATA

Alimentato da 1 pila mezza torcia da 1,5 V. Sostituibile

Bougie à Lumière intermittente
Lounge Durée (6 mois) alimentée d'une pile
moitié bougie (1,5 V), remplaçable.

Flickering Votive Light Long Life it lasts at
least six months requires only a replaceable
1,5 Volt battery(c)

Mariposa de Luz Intermitente Larga
Duración (6 meses), alimentada con una pila
de 1,5 V (c) sustituible.

Universallichter Mit Blinklicht Von Langer
Lebensdauer dauer (6 monaten). Mit
normaler ersetzbarer batterie von 1,5 volt (c).



95 015/0

ACCUMULATORI RICARICABILI

Le lampade a pannelli solari sono dotate di accumulatori ricaricabili la cui durata media è di circa tre anni, in relazione alle condizioni climatiche cui sono sottoposti

Les lampes à panneaux solaires
sont dotées d'accumulateurs
rechargeables dont la durée
moyenne est de 3 ans environ,
selon les conditions climatiques
auxquelles elles sont soumises.

Solar panel lamps are equipped
with rechargeable accumulators
lasting on average about three
years, depending on the climatic
conditions to which they are
exposed.

Las Lámparas con paneles
solares están dotadas de
acumuladores recargables cuya
duración promedio es de unos
tres años, según las condiciones
climáticas a las que se las
somete.

Die Lampen mit Solarplatten
sind mit nachadbaren
Akkumulatoren ausgestattet,
deren Durchschnittsdauer
3 Jahre beträgt, je nach den
Witterungseinflüssen, denen sie
ausgesetzt sind.



95 019/14

Ricambio accumulatori doppi precablati.
Double pre-cabled accumulator spare.
Rechange d'accumulateurs doubles précâblés.
Recambio acumuladores dobles pre-alambrados.
Ersatzteil für vorverkabelte Doppelakkumulatoren

Esempio di applicazione

È indispensabile l'utilizzo di
accumulatori speciali e non di
comuni batterie.

Il est indispensable d'utiliser des
accumulateurs spéciaux et non
pas des batteries ordinaires.

It is Strictly necessary to use
special accumulators instead of
common batteries.

Es indispensable la utilización
de acumuladores especiales y
no de baterias comunes.

Es its unbedingt notwendig,
spezielle Akkumulatoren und
keine gewöhnlichen Batterien zu
verwenden.

LETTERFIX

Collante bicomponente per il fissaggio delle lettere

Colle à deux composants
pour la fixation des lettres

A dual component adhesive
for affixing letters

Cola bicomponente
para la fijación de letras

Zwei-Komponenten-Kleber
zum anbringen der buchstaben



Cartucce
95 044/0
confezione da 6 pz.



Pistola
95 060/0



Beccucci
95 046/0
confezione da 12 pz.



Spatola in acciaio
95 043/0



Kit completo
95 056/0
valigetta, pistola,
6 cartucce, 12 beccucci,
spatola in acciaio
cm +25x26x14

BRONZONET LUCIDANTE SPRAY

Una manutenzione necessaria. Bronzonet è un prodotto a base di cera necessario per la corretta manutenzione di bronzi, acciai, marmi e graniti.
Una periodica applicazione di Bronzonet, seguita da una rapida strofinata, ha il potere di restituire alle superfici la loro iniziale lucentezza e costituisce una valida barriera contro le ossidazioni atmosferiche.

Une entretien nécessaire. Bronzonet est un produit à base de cire nécessaire pour l'entretien correcte de bronzes, aciers, marbles et granits. Une pulvérisation périodique de Bronzonet, suivie d'un rapide coup de chiffon, permet de rendre aux surfaces leur brillance initiale, et constitue une barrière efficace contre les oxydations atmosphériques.

The maintenance needed. Bronzonet is a wax-based product necessary for the proper care and upkeep of bronze, steel, marble and granite surfaces. Regular spraying with Bronzonet, followed by swift rubbing, has the effect of restoring to surfaces their original shine, and is an efficient defence against atmospheric oxidation.

Un mantenimiento necesario. Bronzonet es un producto a base de ceras necesario para la correcta manutención del bronce, acero, mármoles y granitos. Una periódica rociada de Bronzonet, seguida de una rápida frotada, constituye una válida barrera contra la oxidación atmosférica.

Eine Notwendige Instandhaltung. Wach ist die Grundsubstanz des Produktes Bronzonet, das für die Instandhaltung von Bronze, Stahl, Marmor und Granit nötig ist. Ein periodisches Strüpfen von Bronzonet, gefolgt von einem schnellen Abreiben, ist imstande, den Oberflächen ihren anfänglichen Glanz wiederzugeben und hält die witterungsbedingte Anrostung in Schranken.



95 074/300
Bronzonet - contenuto 300 ml



95 068/12
Box 12 Confezioni Bronzonet

MARMO CLEAN

Pulisce e lucida marmo e granito

Pour nettoyer et faire briller le marbre et le granit.

Clean & polish marble & granite.

Limpia y abrillanta marmol y granito.

Um den marmor und granit zu reinigen und glänzend zu machen.



95 080
Marmo Clean
contenuto 400 ml

ACCESSORI E UTENSILI

accessori e utensili outils et accessoires tools and accessories utensilios y accesorios zubehör und werkzeuge

Utensili per la lavorazione di marmi e graniti, con placchetta riportata in metallo duro

Outils pour le travail des marbres et granits, avec plaquette de carbure rapportée

Tools for marble and granite working, tipped by hard metal

Utensilios para trabajos con mármoles y granitos, con punta en metal duro

Werkzeuge für die bearbeitung von marmor und granit mit eingesetztem hartmetallplättchen

Punte verdi per trapano a rotazione, particolarmente indicate per tutti i marmi e graniti.

Mèches vertes pour perceuse rotative, spécialement indiquées pour tous les marbres et granits.

Green nibs for turning drill, particularly suitable for all marbles and granites.

Broca verde, para taladros giratorios, especialmente indicadas para mármoles y granitos.

Grüne Spitzen für Rotierbohrer, besonders geeignet für alle Marmor und Granitarten.

99 012/25 ø mm 2,5

99 012/30 ø mm 3

99 012/35 ø mm 3,5

99 012/40 ø mm 4

99 012/50 ø mm 5

99 012/60 ø mm 6

99 012/70 ø mm 7

99 012/80 ø mm 8

99 012/90 ø mm 9

99 012/100 ø mm 10

99 012/110 ø mm 11

99 012/120 ø mm 12



99012

Punte oro per trapano a percussione, tenacemente resistenti all'urto.

Mèches pointe or pour perceuse à percussion, particulièrement résistantes aux chocs.

Gold nibs for percussion drill, strongly shock-proof.

Broca oro, para taladro a percusión, resistente al choque.

Goldene Spitzen für Stossbohrer, äusserst stossfest.

99 023/30 ø mm 3

99 023/35 ø mm 3,5

99 023/40 ø mm 4

99 023/50 ø mm 5

99 023/60 ø mm 6

99 023/70 ø mm 7

99 023/80 ø mm 8

99 023/90 ø mm 9

99 023/100 ø mm 10

99 023/110 ø mm 11

99 023/120 ø mm 12



99023

Punte per pantografo a 90°.

Pointes à traçer pour pantographe à 90°.

Lip chisels for pantograph 90°.

Punta para pantógrafo a 90°.

Pantografspitzen (90°).

99 015/80 ø mm 8

99 015/100 ø mm 10

99 015/150 ø mm 15



99015

ACCESSORI E UTENSILI

Utensili per la lavorazione di marmi e graniti, con placchetta riportata in metallo duro

Outils pour le travail des marbres et granits, avec plaquette de carbure rapportée

Tools for marble and granite working, tipped by hard metal

Utensilios para trabajos con mármoles y granitos, con punta en metal duro

Werkzeuge für die bearbeitung von marmor und granit mit eingesetztem hartmetallplättchen

Scalpellini per martello pneumatico piccolo, con attacco ø mm 7.
Ciseaux pour petit marteau pneumatique avec diamètre de fixation de 7 mm.
Pneumatic hammer chisels small shank ø mm 7.
Escalpelos para martillo neumático pequeño, con sujeción ø 7 mm.
Meissel für Presslufthammer, klein mit Einsatz ø 7 mm.

Scalpellini a mano, di alta resistenza, per lavorazione mista.
Ciseaux à main, de haute résistance, pour travail mixte.
Hand chisels, high-resistance, for mixed process.
Escalpelos a mano de alta resistencia, para trabajos mixtos.
Handmeissel, äusserst widerstandsfähig, für verschiedene Bearbeitungen.

99 089/40 ø mm 4
99 089/50 ø mm 5
99 089/60 ø mm 6

99 089/70 ø mm 7
99 089/80 ø mm 8
99 089/100 ø mm 10

99 056/30 ø mm 3
99 056/40 ø mm 4
99 056/50 ø mm 5
99 056/60 ø mm 6
99 056/70 ø mm 7
99 056/80 ø mm 8

99 056/100 ø mm 10
99 056/120 ø mm 12
99 056/150 ø mm 15
99 056/180 ø mm 18
99 056/200 ø mm 20
99 056/220 ø mm 22



Punta a segno per tracciare su piani di lavorazione.
Pointe à tracer pour plans de travail.
Scribe round tip, to mark on working surfaces.
Rayador para trazar sobre planos.
Spitzen mit Anreissstift für Bearbeitungsplatten.

99 103/50 ø mm 5

Scalpellini per martello pneumatico, di alta resistenza, per lavorazione mista, con attacco ø mm 12,5.
Ciseaux pour marteau pneumatique, de haute résistance, pour travail mixte, avec diamètre de fixation de 12,5 mm.
Pneumatic hammer chisels, high-resistance, for mixed process, shank ø mm 12,5.
Escalpelos para martillo neumático de alta resistencia, para trabajos mixtos, con sujeción ø 12,5 mm.
Meissel für Presslufthammer, äusserst widerstandsfähig, für verschiedene Bearbeitungen, mit Einsatz ø 12,5 mm.

99 045/50 ø mm 5
99 045/60 ø mm 6
99 045/70 ø mm 7
99 045/80 ø mm 8
99 045/100 ø mm 10

99 045/120 ø mm 12
99 045/150 ø mm 15
99 045/180 ø mm 18
99 045/200 ø mm 20
99 045/220 ø mm 22

ACCESSORI E UTENSILI

accessori e utensili outils et accessoires tools and accessories utensilios y accesorios zubehör und werkzeuge

Subbie per martello pneumatico, adatte per spuntare, tagliare e squadrare marmi, graniti e pietre, con attacco ø mm 12,5.

Ebauchoir pour marteau pneumatique, adapté pour traçer, tailler et équarrir les marbres, les granits et les pierres, avec diamètre de fixation de 12,5 mm. Pneumatic hammer pick chisels, suitable to blunt, cut and square marbles, granites and stones, shank ø mm 12,5.

Puntero para neumático, idóneo para cortar y romper mármoles, granitos y piedras, con sujeción ø 12,5 mm.

Spitzmeißel für Presslufthammer, geeignet zum Abbrechen, Schneiden und Behauen von Marmor, Granit und Stein, mit Einsatz ø 12,5 mm.

99 091/80 ø mm 8

99 091/100 ø mm 10

99 091/120 ø mm 12



Gradine per martello pneumatico piccolo, con attacco ø mm 7.

Gradine pour petit marteau pneumatique avec diamètre de fixation de 7 mm.

Pneumatic hammer tooth-chisels small shank ø mm 7.

Gradina para martillo neumático pequeño, con sujeción ø 7 mm.

Zahnmeißel für Presslufthammer, klein mit Einsatz ø 7 mm.

99 070/62 ø mm 6 denti 2

99 070/63 ø mm 6 denti 3

99 070/83 ø mm 8 denti 3

99 070/84 ø mm 8 denti 4

99 070/103 ø mm 10 denti 3

99 070/104 ø mm 10 denti 4

99 070/105 ø mm 10 denti 5

99 070/124 ø mm 12 denti 4

99 070/125 ø mm 12 denti 5

99 070/153 ø mm 15 denti 3

99 070/154 ø mm 15 denti 4

99 070/155 ø mm 15 denti 5



Subbie a mano, adatte per spuntare, tagliare e squadrare marmi, graniti e pietre.

Ebauchoir à main, adapté pour traçer, tailler et équarrir les marbres, les granits et les pierres.

Hand pick chisels, suitable for blunting cutting and squaring marbles, granites and stones.

Puntero a mano, ideal para despuntar, cortar y romper mármoles, granitos y piedras.

Spitzmeißel, manuelle Ausführung, geeignet zum Abbrechen, Schneiden und Behauen von Marmor, Granit und Stein.

99 078/40 ø mm 4

99 078/50 ø mm 5

99 078/60 ø mm 6

99 078/80 ø mm 8

99 078/100 ø mm 10

Gradine per martello pneumatico, adatte a grandi asportazioni di marmo su blocco e per ornato, con attacco ø mm 12,5.

Gradine pour marteau pneumatique, adaptée à de grandes découpes de marbre sur le bloc brut et pour les ornements, avec diamètre de fixation de 12,5 mm.

Pneumatic hammer tooth-chisels, used for large-scale removals of marble from block and for ornament operations, shank ø mm 12,5.

Gradina para martillo neumático, ideal para hacer ornamentos en el marmol, con sujeción ø 12,5 mm.

Zahnmeißel für Presslufthammer, geeignet zur massiven Beseitigung von Block-Marmor und zur Verzierung, mit Einsatz ø 12,5 mm.

99 067/120 ø mm 12 denti 3

99 067/150 ø mm 15 denti 3

99 067/180 ø mm 18 denti 3

99 067/200 ø mm 20 denti 4

99 067/220 ø mm 22 denti 4

ACCESSORI E UTENSILI

PER UN'ORDINATA DISPOSIZIONE DEGLI ALFABETI

Pour une disposition
ordonee des alphabets

For a orderly
arrangement of alphabets

Para una ordenada
disposición de los alfabetos

Für eine geordnete
aufstellung der schriftzeichen



Mobiletto per caratteri

95 119/4 - 4 cassetti

95 119/8 - 8 cassetti

SISTEMI ESPOSITIVI





95 165/0
cm ±190x62,±42
Espositore a vetrina ovale



95 180/0
cm ±183x53,±39
Espositore a vetrina quadrato

ESPOSITORE GIREVOLE



Vista zenitale

Espositore girevole
99 999/180
cm :212x1087

ESPOSITORE URNE



Espositore urne
99 999/227
cm :143x81x61

ESPOSITORE PER CINERARI



Espositore per cinerari

99 999/110
cm 185,0x50



INDICE

Assistenza Clienti:
Tel. +39 0521 5208
servizio.clienti@caggiati.it



Uffici Commerciali
Via Galileo Galilei, 1
43052 Colomo - Parma - Italy

www.caggiati.it

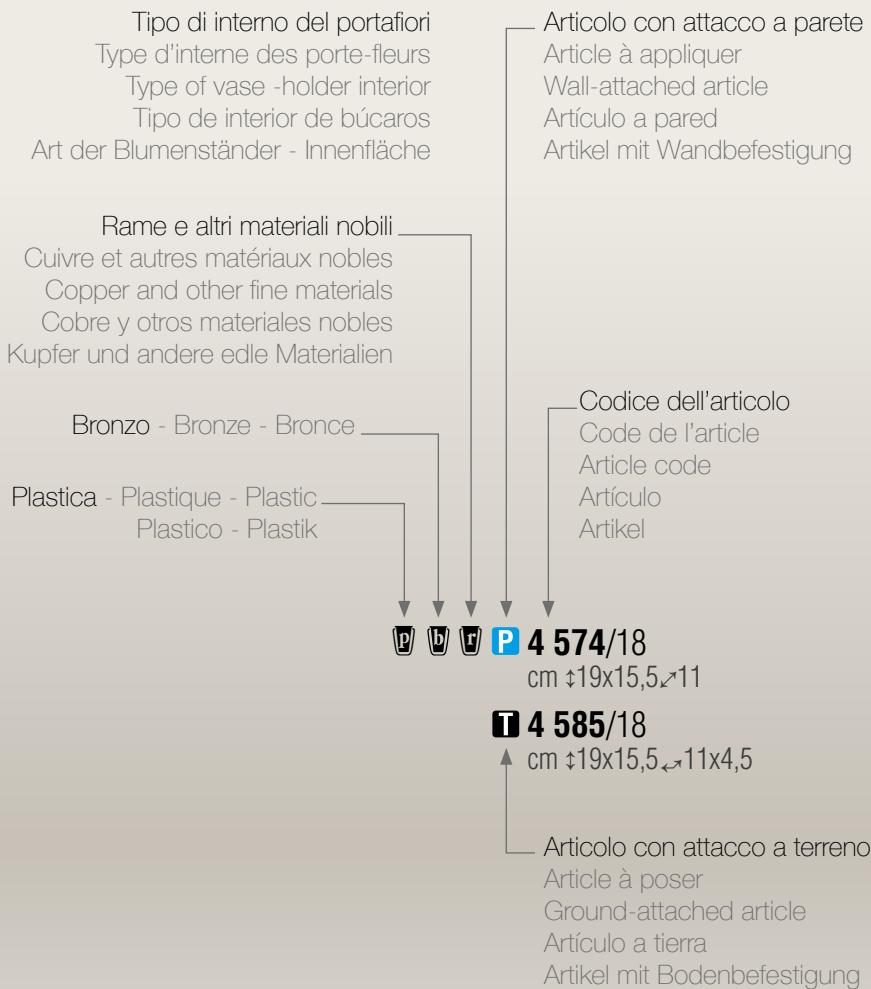

I PREZZI SI INTENDONO IVA 22% INCLUSA
IL PRESENTE LISTINO ANNULLA E SOSTITUISCE TUTTI I PRECEDENTI

Indicazioni per l'ordinazione	Indications pour les commandes	Instructions for orders	Indicaciones para su pedido	Bestellangaben
Per l'ordinazione riportare solamente il numero di codice e l'altezza dell'articolo.	Pour les commandes, il suffit d'indiquer le numéro de code et la hauteur des articles désirés.	To place an order please note only the reference-number and the height of the article.	Para hacer su pedido debe hacer constar solamente el numero de código y la altura del artículo.	Bei der Bestellung ist nur die Kode-Nr. und die Höhe des Art anzugeben.

AVVERTENZA
Tutti i disegni, i modelli e stampe sono di esclusiva proprietà della Matthews International spa e quindi sono tutelati dalle norme in materia di diritto d'Autore.
La loro riproduzione parziale o totale è pertanto vietata.

AVERTISSEMENT
Tous les dessins, modèles et illustrations sont propriété exclusive de la Matthews International spa et sont protégés par la législation sur les droites d'auteurs.
Toute reproduction partielle ou totale en est interdite.

NOTE
All the designs, models are the exclusive property of Matthews International spa and all rights are therefore reserved.
The reproduction of partial or all is strictly forbidden.

ADVERTENCIA
Todo diseño y modelo impreso es de la única y exclusiva propiedad de Matthews International spa, y por lo tanto están protegidos por la ley de derechos de autor.
La sola reproducción parcial o total está rigurosamente prohibida.

HINWEIS
Sämtliche Zeichnungen, Modelle und Formern sind ausschließliches Eigentum der Matthews International spa und sind insofern durch das Gesetz des Urheberrechts geschützt.
Ihre partielle oder komplette Nachahmung ist verboten.

CARATTERI		
Codice Articolo	Descrizione	
LYDIAN BRONZO pag.264		
	Lettere, numeri, stelle, croci alt. cm. 2,5	
	Lettere alt. cm. 4	
	Lettere alt. cm. 5	
74051	Punto piccolo	
74052	Punto medio	
74056	Virgola piccola	
74057	Virgola media	
74061	Accento piccolo	
74062	Accento medio	
74066	Trattino piccolo	
74067	Trattino medio	
LYDIAN UNIBLANC pag.265		
	Lettere, numeri, stelle, croci alt. cm. 2,5	
	Lettere alt. cm. 4	
	Lettere alt. cm. 5	
74051	Punto piccolo	
74052	Punto medio	
74056	Virgola piccola	
74057	Virgola media	
74061	Accento piccolo	
74062	Accento medio	
74066	Trattino piccolo	
74067	Trattino medio	
MUNDIAL BRONZO da pag.266 a pag.267		
	Lettere, numeri, stelle e croci alt. cm. 2,5	
	Lettere, numeri, stelle e croci alt. cm. 3	
	Lettere, numeri, stelle e croci alt. cm. 4	
	Lettere, numeri, stelle e croci alt. cm. 5	
	Lettere alt. cm. 6	
	Lettere alt. cm. 8	
	Lettere alt. cm. 10	
40051	Punto piccolo	
40053	Punto medio	
40055	Punto grande	
40056	Virgola piccola	
40058	Virgola media	
40060	Virgola grande	
40057	Accento piccolo	
40059	Accento medio	
40063	Trattino piccolo	
40064	Trattino grande	
40061	Accento circonflesso piccolo	
40062	Accento circonflesso grande	
40255	"£" cm. 2,5	
40304	"£" cm. 3	
40401	"£" cm. 4	
40503	"£" cm. 5	
40602	"£" cm. 6	
40257	"Ø" cm. 2,5	
40305	"Ø" cm. 3	
40258	"AE" cm. 2,5	
40308	"AE" cm. 3	
40070	Accento ridotto spec.	
40071	Accento piccolo spec.	
40072	Accento medio spec.	
40074	Accento circonf. ridotto spec.	
40075	Accento circonf. piccolo spec.	
MUNDIAL ORO da pag.266 a pag.267		
	Lettere, numeri, stelle e croci alt. cm. 2,5	
	Lettere, numeri, stelle e croci alt. cm. 3	
	Lettere, numeri, stelle e croci alt. cm. 4	
	Lettere, numeri, stelle e croci alt. cm. 5	
	Lettere alt. cm. 6	

CARATTERI		
Codice Articolo	Descrizione	
40051	Punto piccolo	
40053	Punto medio	
40056	Virgola piccola	
40058	Virgola media	
40057	Accento piccolo	
40059	Accento medio	
40063	Trattino piccolo	
40071	Accento piccolo spec.	
MUNDIAL DARK da pag.266 a pag.267		
	Lettere, numeri, stelle e croci alt. cm. 2,5	
	Lettere, numeri, stelle e croci alt. cm. 3	
	Lettere, numeri, stelle e croci alt. cm. 4	
	Lettere, numeri, stelle e croci alt. cm. 5	
	Lettere alt. cm. 6	
40051	Punto piccolo	
40053	Punto medio	
40056	Virgola piccola	
40058	Virgola media	
40057	Accento piccolo	
40059	Accento medio	
40063	Trattino piccolo	
40071	Accento piccolo spec.	
MUNDIAL UNIBLANC da pag.266 a pag.267		
	Lettere, numeri, stelle e croci alt. cm. 2,5	
	Lettere, numeri, stelle e croci alt. cm. 3	
	Lettere, numeri, stelle e croci alt. cm. 4	
	Lettere, numeri, stelle e croci alt. cm. 5	
40051	Punto piccolo	
40053	Punto medio	
40056	Virgola piccola	
40058	Virgola media	
40057	Accento piccolo	
40059	Accento medio	
40063	Trattino piccolo	
MUNDIAL CLASSIC da pag.266 a pag.267		
	Lettere, numeri, stelle e croci alt. cm. 2,5	
	Lettere, numeri, stelle e croci alt. cm. 3	
	Lettere, numeri, stelle e croci alt. cm. 4	
	Lettere, numeri, stelle e croci alt. cm. 5	
40051	Punto piccolo	
40053	Punto medio	
40056	Virgola piccola	
40058	Virgola media	
40057	Accento piccolo	
40059	Accento medio	
40063	Trattino piccolo	
MUNDIAL BOTTICINO da pag.266 a pag.267		
	Lettere, numeri, stelle e croci alt. cm. 2,5	
	Lettere, numeri, stelle e croci alt. cm. 3	
	Lettere alt. cm. 4	
	Lettere alt. cm. 5	
40751	Punto piccolo	
40753	Punto medio	
40756	Virgola piccola	
40758	Virgola media	
40757	Accento piccolo	
40759	Accento medio	
40763	Trattino piccolo	
MUNDIAL CARRARA da pag.266 a pag.267		

CARATTERI	
Codice Articolo	Descrizione
	Lettere, numeri, stelle e croci alt. cm. 2,5
	Lettere, numeri, stelle e croci alt. cm. 3
	Lettere alt. cm. 4
	Lettere alt. cm. 5
40951	Punto piccolo
40953	Punto medio
40956	Virgola piccola
40958	Virgola media
40957	Accento piccolo
40959	Accento medio
40963	Trattino piccolo

MUNDIAL DECORATO (nei nuovi colori) da pag.266 a pag.267	
	Lettere, numeri, stelle e croci alt. cm. 2,5
	Lettere, numeri, stelle e croci alt. cm. 3
	Lettere alt. cm. 4
	Lettere alt. cm. 5
	Punteggiatura

VILVO da pag.268 a pag.269	
	Lettere, numeri, stelle, croci alt. cm. 3
	Lettere, numeri alt. cm. 4
	Lettere alt. cm. 5
49000	Punto piccolo
49001	Punto grande
49002	Virgola piccola
49003	Accento piccolo
49004	Trattino piccolo
49310	"ALFA" cm. 3
49320	"OMEGA" cm. 3

ARMONY pag.270	
	Lettere, numeri, stelle e croci alt. cm. 2,5
	Lettere, numeri, stelle e croci alt. cm. 3
	Lettere, numeri alt. cm. 4
	Lettere alt. cm. 5
50001	Punto
50002	Virgola
50004	Trattino
50003	Accento circonflesso
50300	"£" cm. 3
50400	"£" cm. 4
50500	"£" cm. 5

ELITE pag.271	
	Lettere, numeri, stelle e croci alt. cm. 2,5
	Lettere, numeri, stelle e croci alt. cm. 3
	Lettere, numeri, stelle e croci alt. cm. 4
	Lettere alt. cm. 5
	Lettere alt. cm. 6
41052	Punto piccolo
41053	Punto grande
41057	Virgola piccola
41059	Virgola grande
41058	Accento piccolo
41055	Trattino piccolo
41056	Trattino grande

DUPLO BRONZO da pag.272 a pag.273	
	Numeri, stelle e croci, N e M alt. cm. 2,5
	Lettere minuscole, numeri, stelle e croci, N e M alt. cm. 3
	Lettere maiuscole alt. cm. 4,5
48052	Punto
48051	Apostrofo - Virgola

CARATTERI	
Codice Articolo	Descrizione
48054	Accento
48055	Trattino
48303	"Ø" cm. 3
48453	"Ø" cm. 4,5
48304	"£" minuscola cm. 3
48454	"£" maiuscola cm. 4,5

ROMANO BRONZO da pag.274 a pag.275	
	Lettere, numeri alt. cm. 1,5
	Lettere, numeri, stelle e croci alt. cm. 2
	Lettere, numeri, stelle e croci alt. cm. 2,5
	Lettere, numeri, stelle e croci alt. cm. 3
	Lettere, numeri, stelle e croci alt. cm. 4
	Lettere, numeri, stelle e croci alt. cm. 5
	Lettere alt. cm. 6
	Lettere, numeri alt. cm. 8
	Lettere, numeri alt. cm. 10
	Lettere, numeri alt. cm. 12
	Lettere, numeri alt. cm. 15
46064	Punto piccolo
46051	Punto medio
46052	Punto grande
46053	Virgola piccola
46055	Virgola media
46081	Virgola grande
46054	Accento piccolo
46080	Accento medio
46082	Accento grande
46057	Trattino
46058	Trattino cm. 3
46059	Trattino cm. 4
46060	Trattino cm. 5
46017	PAX
	alt. cm. 6
	alt. cm. 8
46251	"AE" cm. 2,5
46310	"AE" cm. 3
46252	"Ø" cm. 2,5
46311	"Ø" cm. 3
46253	"ALFA" cm. 2,5
46312	"ALFA" cm. 3
46254	"OMEGA" cm. 2,5
46313	"OMEGA" cm. 3
46258	"CROCE" cm. 2,5
46255	"£" cm. 2,5
46314	"£" cm. 3
46410	"£" cm. 4
46511	"£" cm. 5
46610	"£" cm. 6
46810	"£" cm. 8
46063	Accento circonflesso piccolo
46056	Accento circonflesso medio
46061	Accento circonflesso grande
46062	Tilde
46065	Punto piccolo speciale
46066	Punto medio speciale
46068	Trattino piccolo speciale
46069	Trattino grande speciale
46070	Accento ridotto speciale
46071	Accento piccolo speciale
46072	Accento medio speciale
46074	Accento circonf. ridotto speciale
46075	Accento circonf. piccolo speciale
46076	Accento circonf. medio speciale

ROMANO ORO pag.276	
	Lettere, numeri, stelle e croci alt. cm. 2,5

CARATTERI	
Codice Articolo	Descrizione
	Lettere, numeri, stelle e croci alt. cm. 3
	Lettere, numeri, stelle e croci alt. cm. 4
	Lettere alt. cm. 5
46064	Punto piccolo
46051	Punto medio
46053	Virgola piccola
46055	Virgola media
46054	Accento piccolo
46080	Accento medio
46057	Trattino
46258	"CROCE" cm. 2,5
46255	"£" cm. 2,5
46314	"£" cm. 3
46070	Accento ridotto speciale
46071	Accento piccolo speciale
46072	Accento medio speciale
46074	Accento circonf.ridotto speciale
46075	Accento circonf.piccolo speciale
46076	Accento circonf.medio speciale

ROMANO CLASSIC

pag.277

	Lettere, numeri, stelle e croci alt. cm. 2
	Lettere, numeri, stelle e croci alt. cm. 2,5
	Lettere, numeri, stelle e croci alt. cm. 3
	Lettere, numeri, stelle e croci alt. cm. 4
	Lettere, numeri, stelle e croci alt. cm. 5
	Lettere alt. cm. 6
46064	Punto piccolo
46051	Punto medio
46052	Punto grande
46053	Virgola piccola
46055	Virgola media
46054	Accento piccolo
46080	Accento medio
46057	Trattino
46058	Trattino cm. 3
46059	Trattino cm. 4
46063	Accento circonflesso piccolo

ROMANO AUTOADESIVO BRONZO

da pag.274 a pag.275

	Lettere, numeri, stelle e croci alt. cm. 2,5
	Lettere, numeri, stelle e croci alt. cm. 3
	Lettere, numeri, stelle e croci alt. cm. 4
	Lettere alt. cm. 5
47064	Punto piccolo
47051	Punto medio
47053	Virgola piccola
47055	Virgola media
47054	Accento piccolo
47057	Trattino

CIRILLO ROMANO BRONZO

pag.278

	Lettere e numeri alt. cm. 3
	Numeri alt. cm. 4
	Lettere e numeri alt. cm. 5
46051	Punto medio
46055	Virgola media
46056	Accento circonflesso medio
46057	Trattino

CIRILLO MUNDIAL BRONZO

pag.279

	Lettere e numeri alt. cm. 3
	Lettere e numeri alt. cm. 5
40051	Punto piccolo
40053	Punto medio
40056	Virgola piccola
40058	Virgola media

CARATTERI	
Codice Articolo	Descrizione
40061	Accento circonflesso piccolo
40062	Accento circonflesso grande
40063	Trattino piccolo
40064	Trattino medio

CORSIVO Istant BRONZO

da pag.280 a pag.285

	Lettere maiuscole alt. cm. 5,5
	Lettere minuscole alt. cm. 3
	Numeri, stelle, croci, N e M alt. cm. 3 (predisposti per l'applicazione su barretta)
	Numeri, stelle, croci, N e M alt. cm. 3 (da comporre singolarmente s/barrette)
	Lettere minuscole alt. cm. 2,5
	Numeri, stelle, croci, N e M alt. cm. 2,5 (predisposti per l'applicazione su barretta)
	Numeri, stelle, croci, N e M alt. cm. 2,5 (da comporre singolarmente s/barrette)
44061	Gambetta iniziale di minuscola per cm.2,5-3
44004	Barretta per composizione date carattere corsivo cm. 2,5 e 3 Larg. cm. 10 Larg. cm. 17,5 Larg. cm. 23 Larg. cm. 31
	Lettere maiuscole alt. cm. 7,5
	Lettere minuscole alt. cm. 4
	Numeri, stelle, croci, N e M alt. cm. 4 (predisposti per l'applicazione su barretta)
	Numeri, stelle, croci, N e M alt. cm. 4 (da comporre singolarmente senza barrette)
44062	Gambetta iniziale di minuscola per cm.4
44048	Barretta per composizione date carattere corsivo alt. cm. 4 Larg. cm. 13,5 Larg. cm. 24 Larg. cm. 31 Larg. cm. 40,5
	Lettere maiuscole alt. cm. 16
	Lettere minuscole alt. cm. 8
44051	Punto piccolo
44053	Punto grande
44054	Punto per asta
44055	Accento
44056	Virgola
44057	Trattino
44068	Trattino piccolo lineare
44069	Trattino grande lineare
44058	Accento circonflesso piccolo
44066	Accento circonflesso grande
44059	Punto piccolo allungato
44073	Accento circonf. piccolo spec.
44305	"£" minuscola intermedia cm. 3
44405	"£" minuscola intermedia cm. 4
44324	"£" minuscola terminale cm. 3
44424	"£" minuscola terminale cm. 4
44553	"£" maiuscola cm. 5,5
44753	"£" maiuscola cm. 7,5
44257	"i" minuscola intermedia cm. 2,5
44304	"i" minuscola intermedia cm. 3
44404	"i" minuscola intermedia cm. 4

CORSIVO Istant ORO

da pag.280 a pag.285

	Lettere maiuscole alt. cm. 5,5
	Lettere minuscole alt. cm. 3
	Numeri, stelle, croci, N e M alt. cm. 3 (predisposti per l'applicazione su barretta)
	Numeri, stelle, croci, N e M alt. cm. 3 (da comporre singolarmente s/barrette)

CARATTERI	
Codice Articolo	Descrizione
	Lettere minuscole alt. cm. 2,5 Numeri, stelle, croci, N e M alt. cm. 2,5 (predisposti per l'applicazione su barretta)
44061	Numeri, stelle, croci, N e M alt. cm. 2,5 (da comporre singolarmente s/barrette)
44004	Gambetta iniziale di minuscola per cm.2,5-3 Barretta per composizione date carattere corsivo alt. cm. 2,5 e 3 Larg. cm. 10 Larg. cm. 17,5 Larg. cm. 23 Larg. cm. 31 Lettere maiuscole alt. cm. 7,5 Lettere minuscole alt. cm. 4
	Numeri, stelle, croci, N e M alt. cm. 4 (predisposti per l'applicazione su barretta)
44062	Numeri, stelle, croci, N e M alt. cm. 4 (da comporre singolarmente senza barrette)
44048	Gambetta iniziale di minuscola per cm.4 Barretta per composizione date carattere corsivo alt. cm. 4 Larg. cm. 13,5 Larg. cm. 24 Larg. cm. 31 Larg. cm. 40,5 Lettere maiuscole alt. cm. 16 Lettere minuscole alt. cm. 8
44051	Punto piccolo
44053	Punto grande
44054	Punto per asta
44055	Accento
44056	Virgola
44057	Trattino

CORSIVO ISTANT DARK

da pag.280 a pag.285

	Lettere maiuscole alt. cm. 5,5 Lettere minuscole alt. cm. 3 Numeri, stelle, croci, N e M alt. cm. 3 (predisposti per l'applicazione su barretta)
	Numeri, stelle, croci, N e M alt. cm. 3 (da comporre singolarmente s/barrette)
	Lettere minuscole alt. cm. 2,5 Numeri, stelle, croci, N e M alt. cm. 2,5 (predisposti per l'applicazione su barretta)
	Numeri, stelle, croci, N e M alt. cm. 2,5 (da comporre singolarmente s/barrette)
44061	Gambetta iniziale di minuscola per cm.2,5-3
44004	Barretta per composizione date carattere corsivo cm. 2,5 e 3 Larg. cm. 10 Larg. cm. 17,5 Larg. cm. 23 Larg. cm. 31 Lettere maiuscole alt. cm. 7,5 Lettere minuscole alt. cm. 4
	Numeri, stelle, croci, N e M alt. cm. 4 (predisposti per l'applicazione su barretta)
	Numeri, stelle, croci, N e M alt. cm. 4 (da comporre singolarmente s/barrette)
44062	Gambetta iniziale di minuscola per cm.4
44048	Barretta per composizione date carattere corsivo alt. cm. 4 Larg. cm. 13,5 Larg. cm. 24 Larg. cm. 31 Larg. cm. 40,5 Lettere maiuscole alt. cm. 16 Lettere minuscole alt. cm. 8
44051	Punto piccolo

CARATTERI	
Codice Articolo	Descrizione
44053	Punto grande
44054	Punto per asta
44055	Accento
44056	Virgola
44057	Trattino

CORSIVO ISTANT UNIBLANC

da pag.280 a pag.285

	Lettere maiuscole alt. cm. 5,5 Lettere minuscole alt. cm. 3 Numeri, stelle, croci, N e M alt. cm. 3 (predisposti per l'applicazione su barretta)
	Numeri, stelle, croci, N e M alt. cm. 3 (da comporre singolarmente s/barrette)
	Lettere minuscole alt. cm. 2,5 Numeri, stelle, croci, N e M alt. cm. 2,5 (predisposti per l'applicazione su barretta)
	Numeri, stelle, croci, N e M alt. cm. 2,5 (da comporre singolarmente s/barrette)
44061	Gambetta iniziale di minuscola per cm.2,5-3
44004	Barretta per composizione date carattere corsivo cm. 2,5 e 3 Larg. cm. 10 Larg. cm. 17,5 Larg. cm. 23 Larg. cm. 31
44051	Punto piccolo
44054	Punto per asta
44055	Accento
44056	Virgola
44057	Trattino

CORSIVO ISTANT CLASSIC

da pag.280 a pag.285

	Lettere maiuscole alt. cm. 5,5 Lettere minuscole alt. cm. 3 Numeri, stelle, croci, N e M alt. cm. 3 (predisposti per l'applicazione su barretta)
	Numeri, stelle, croci, N e M alt. cm. 3 (da comporre singolarmente s/barrette)
	Lettere minuscole alt. cm. 2,5 Numeri, stelle, croci, N e M alt. cm. 2,5 (predisposti per l'applicazione su barretta)
	Numeri, stelle, croci, N e M alt. cm. 2,5 (da comporre singolarmente s/barrette)
44061	Gambetta iniziale di minuscola per cm.2,5-3
44004	Barretta per composizione date carattere corsivo cm. 2,5 e 3 Larg. cm. 10 Larg. cm. 17,5 Larg. cm. 23 Larg. cm. 31
44051	Punto piccolo
44054	Punto per asta
44055	Accento
44056	Virgola
44057	Trattino

CORSIVO ISTANT BOTTICINO

da pag.280 a pag.285

	Lettere maiuscole alt. cm. 5,5 Lettere minuscole alt. cm. 3 Numeri, stelle, croci, N e M alt. cm. 3 (da comporre singolarmente s/barrette)
44661	Gambetta iniziale di minuscola per cm. 3
44651	Punto piccolo
44655	Accento
44656	Virgola
44657	Trattino

CORSIVO ISTANT CARRARA

da pag.280 a pag.285

	Lettere maiuscole alt. cm. 5,5
--	--------------------------------

CARATTERI	
Codice Articolo	Descrizione
	Lettere minuscole alt. cm. 3
	Numeri, stelle, croci, N e M alt. cm. 3 (da comporre singolarmente s/barrette)
44961	Gambetta iniziale di minuscola per cm. 3
44951	Punto piccolo
44955	Accento
44956	Virgola
44957	Trattino

CARATTERE ITALICO (BRONZO 87 SP.MM.6) pag.286

69 915	Lettere e numeri alt. cm. 1,5
69 920	Lettere e numeri alt. cm. 2
69 925	Lettere e numeri alt. cm. 2,5
69 930	Lettere e numeri alt. cm. 3
69 940	Lettere e numeri alt. cm. 4

CARATTERE SENESE (BRONZO 87 SP.MM.6) pag.286

69 922	Lettere e numeri alt. cm. 2
69 927	Lettere e numeri alt. cm. 2,5
69 932	Lettere e numeri alt. cm. 3
69 942	Lettere e numeri alt. cm. 4
69 952	Lettere e numeri alt. cm. 5

CARATTERE UMBRO (BRONZO 87 SP.MM.6) pag.286

69 916	Lettere e numeri alt. cm. 1,5
69 921	Lettere e numeri alt. cm. 2
69 926	Lettere e numeri alt. cm. 2,5
69 931	Lettere e numeri alt. cm. 3
69 941	Lettere e numeri alt. cm. 4

CARATTERE ITALICO SATINATO (BR.87 SP.MM.6) pag.286

69 710	Lettere e numeri alt. cm. 1,5
69 712	Lettere e numeri alt. cm. 2
69 713	Lettere e numeri alt. cm. 2,5
69 733	Lettere e numeri alt. cm. 3
69 746	Lettere e numeri alt. cm. 4

CARATTERE SENESE SATINATO (BR.87 SP.MM.6) pag.286

69 723	Lettere e numeri alt. cm. 2
69 724	Lettere e numeri alt. cm. 2,5
69 736	Lettere e numeri alt. cm. 3
69 743	Lettere e numeri alt. cm. 4
69 750	Lettere e numeri alt. cm. 5

CARATTERE UMBRO SATINATO (BR.87 SP.MM.6) pag.286

69 715	Lettere e numeri alt. cm. 1,5
69 720	Lettere e numeri alt. cm. 2
69 725	Lettere e numeri alt. cm. 2,5
69 730	Lettere e numeri alt. cm. 3
69 740	Lettere e numeri alt. cm. 4

CARATTERE ITALICO GOLD (BRONZO 87 SP.MM.6) pag.286

69 810	Lettere e numeri alt. cm. 1,5
69 812	Lettere e numeri alt. cm. 2
69 813	Lettere e numeri alt. cm. 2,5
69 833	Lettere e numeri alt. cm. 3
69 846	Lettere e numeri alt. cm. 4

CARATTERE SENESE GOLD (BRONZO 87 SP.MM.6) pag.286

69 823	Lettere e numeri alt. cm. 2
69 824	Lettere e numeri alt. cm. 2,5
69 836	Lettere e numeri alt. cm. 3
69 843	Lettere e numeri alt. cm. 4
69 850	Lettere e numeri alt. cm. 5

CARATTERE UMBRO GOLD (BRONZO 87 SP.MM.6) pag.286

69 815	Lettere e numeri alt. cm. 1,5
69 820	Lettere e numeri alt. cm. 2
69 825	Lettere e numeri alt. cm. 2,5

CARATTERI	
Codice Articolo	Descrizione
69 830	Lettere e numeri alt. cm. 3
69 840	Lettere e numeri alt. cm. 4

CARATTERE "FIRMA BRONZO" Sp.mm.3 pag.287

71 000	Firma Bronzo Minusc.2-2,5-3
---------------	-----------------------------

BASTONE UNIBLOCK BRONZO sp.mm.3 pag.287

73215	Lettere e numeri alt. cm.1,5
73220	Lettere e numeri alt. cm.2
73225	Lettere e numeri alt. cm.2,5
73230	Lettere e numeri alt. cm.3

ROMANO UNIBLOCK BRONZO sp.mm.3 pag.287

73120	Lettere e numeri alt. cm.2
73125	Lettere e numeri alt. cm.2,5
73130	Lettere e numeri alt. cm.3

CORSIVO TRAFORATO CLASSICO sp.mm.3 pag.288

69150	Lettere e numeri alt. cm. 1,5
69200	Lettere e numeri alt. cm. 2
69250	Lettere e numeri alt. cm. 2,5
69300	Lettere e numeri alt. cm. 3
69400	Lettere e numeri alt. cm. 4
69500	Lettere e numeri alt. cm. 5
69600	Lettere e numeri alt. cm. 6
69800	Lettere e numeri alt. cm. 8
69100	Lettere e numeri alt. cm. 10

CORSIVO TRAFORATO ELEGANTE sp.mm.3 pag.288

69152	Lettere e numeri alt. cm. 1,5
69202	Lettere e numeri alt. cm. 2
69252	Lettere e numeri alt. cm. 2,5
69302	Lettere e numeri alt. cm. 3
69402	Lettere e numeri alt. cm. 4
69502	Lettere e numeri alt. cm. 5
69602	Lettere e numeri alt. cm. 6
69802	Lettere e numeri alt. cm. 8
69102	Lettere e numeri alt. cm. 10

CORSIVO TRAFORATO FUTURA sp.mm.3 pag.288

69154	Lettere e numeri alt. cm. 1,5
69204	Lettere e numeri alt. cm. 2
69254	Lettere e numeri alt. cm. 2,5
69304	Lettere e numeri alt. cm. 3
69404	Lettere e numeri alt. cm. 4
69504	Lettere e numeri alt. cm. 5
69604	Lettere e numeri alt. cm. 6
69804	Lettere e numeri alt. cm. 8
69104	Lettere e numeri alt. cm. 10

CORSIVO TRAFORATO INGLESE sp.mm.3 pag.288

70150	Lettere e numeri alt. cm. 1,5
70200	Lettere e numeri alt. cm. 2
70250	Lettere e numeri alt. cm. 2,5
70300	Lettere e numeri alt. cm. 3
70350	Lettere e numeri alt. cm. 3,5
70400	Lettere e numeri alt. cm. 4
70500	Lettere e numeri alt. cm. 5
70600	Lettere e numeri alt. cm. 6
70800	Lettere e numeri alt. cm. 8
70100	Lettere e numeri alt. cm. 10

CORSIVO TRAFORATO MEDITERRANEO sp.mm.3 pag.288

70160	Lettere e numeri alt. cm. 1,5
--------------	-------------------------------

CARATTERI	
Codice Articolo	Descrizione
70210	Lettere e numeri alt. cm. 2
70260	Lettere e numeri alt. cm. 2,5
70310	Lettere e numeri alt. cm. 3
70360	Lettere e numeri alt. cm. 3,5
70410	Lettere e numeri alt. cm. 4
70510	Lettere e numeri alt. cm. 5
70610	Lettere e numeri alt. cm. 6
70810	Lettere e numeri alt. cm. 8
70101	Lettere e numeri alt. cm. 10

CORSIVO TRAFORATO MEDITERRANEO sp.mm.5 pag.288	
70270	Lettere e numeri alt. cm. 2,5
70320	Lettere e numeri alt. cm. 3
70370	Lettere e numeri alt. cm. 3,5
70420	Lettere e numeri alt. cm. 4
70520	Lettere e numeri alt. cm. 5

ROMANO TRAFORATO SU ASTA sp.mm.3 pag.288	
70290	Lettere e numeri alt. cm. 2,5
70330	Lettere e numeri alt. cm. 3
70430	Lettere e numeri alt. cm. 4
70540	Lettere e numeri alt. cm. 5
70820	Lettere e numeri alt. cm. 8
70102	Lettere e numeri alt. cm. 10
70120	Lettere e numeri alt. cm. 12

CORSIVO TRAFORATO GARDA sp.mm.3 pag.289	
75200	Lettere e numeri alt. cm.2
75250	Lettere e numeri alt. cm.2,5
75300	Lettere e numeri alt. cm.3
75400	Lettere e numeri alt. cm.4
75500	Lettere e numeri alt. cm.5
75600	Lettere e numeri alt. cm.6
75800	Lettere e numeri alt. cm.8
75100	Lettere e numeri alt. cm.10

CORSIVO TRAFORATO GARDA sp.mm.5 pag.289	
72250	Lettere e numeri alt. cm.2,5
72300	Lettere e numeri alt. cm.3
72400	Lettere e numeri alt. cm.4
72500	Lettere e numeri alt. cm.5

CORSIVO TRAFORATO AMALFI sp.mm.3 pag.289	
64200	Lettere e numeri alt. cm.2
64250	Lettere e numeri alt. cm.2,5
64300	Lettere e numeri alt. cm.3
64400	Lettere e numeri alt. cm.4
64500	Lettere e numeri alt. cm.5
64600	Lettere e numeri alt. cm.6
64800	Lettere e numeri alt. cm.8
64100	Lettere e numeri alt. cm.10

CORSIVO TRAFORATO AMALFI sp.mm.5 pag.289	
61250	Lettere e numeri alt. cm.2,5
61300	Lettere e numeri alt. cm.3
61400	Lettere e numeri alt. cm.4
61500	Lettere e numeri alt. cm.5

ROMANO TRAFORATO INOX sp.mm.3 pag.294	
	Lettere, numeri, stelle e croci alt. cm. 2,5
	Lettere, numeri, stelle e croci alt. cm. 3
	Lettere alt. cm. 4

CARATTERI	
Codice Articolo	Descrizione
	Lettere alt. cm. 5
89064	Punto
89053	Virgola
89054	Accento
89057	Trattino
89255	"£" cm. 2,5
89314	"£" cm. 3
89410	"£" cm. 4
89510	"£" cm. 5

ROMANO ACCIAIO pag.295	
	Lettere, numeri, stelle e croci alt. cm. 2
	Lettere, numeri, stelle e croci alt. cm. 2,5
	Lettere, numeri, stelle e croci alt. cm. 3,5
	Lettere alt. cm. 4,5
	Lettere alt. cm. 6
85051	Punto
85056	Virgola, accento
85057	Trattino

MUNDIAL INOX pag.296	
	Lettere, numeri, stelle e croci alt. cm. 2,5
	Lettere, numeri, stelle e croci alt. cm. 3
	Lettere alt. cm. 4
	Lettere alt. cm. 5
	Lettere alt. cm. 6
88051	Punto
88056	Virgola, accento
88057	Trattino

CARATTERE "FIRMA INOX" sp.mm.3 pag.297	
51000	Firma Acciaio Inox Minusc.2-2,5-3

BASTONE UNIBLOCK ACCIAIO sp.mm.3 pag.297	
57215	Lettere e numeri alt. cm.1,5
57220	Lettere e numeri alt. cm.2
57225	Lettere e numeri alt. cm.2,5
57230	Lettere e numeri alt. cm.3

ROMANO UNIBLOCK ACCIAIO sp.mm.3 pag.297	
57120	Lettere e numeri alt. cm.2
57125	Lettere e numeri alt. cm.2,5
57130	Lettere e numeri alt. cm.3

CORSIVO TRAFORATO INOX ALBATROS sp.mm.3 pag.298	
55153	Lettere e numeri alt. cm. 1,5
55203	Lettere e numeri alt. cm. 2
55253	Lettere e numeri alt. cm. 2,5
55303	Lettere e numeri alt. cm. 3
55403	Lettere e numeri alt. cm. 4
55503	Lettere e numeri alt. cm. 5
55603	Lettere e numeri alt. cm. 6
55803	Lettere e numeri alt. cm. 8
55103	Lettere e numeri alt. cm. 10
53000	Punteggiatura

CORSIVO TRAFORATO INGLESE INOX sp.mm.3 pag.298	
59150	Lettere e numeri alt. cm.1,5
59200	Lettere e numeri alt. cm.2
59250	Lettere e numeri alt. cm.2,5
59300	Lettere e numeri alt. cm.3
59350	Lettere e numeri alt. cm.3,5
59400	Lettere e numeri alt. cm.4
59500	Lettere e numeri alt. cm.5
59600	Lettere e numeri alt. cm.6
59800	Lettere e numeri alt. cm.8
59100	Lettere e numeri alt. cm.10

CARATTERI

Codice Articolo	Descrizione	
53000	Punteggiatura	
AMALFI TRAFORATO INOX sp. mm. 3		pag. 298
51202	Lettere e numeri alt. cm. 2	
51252	Lettere e numeri alt. cm. 2,5	
51302	Lettere e numeri alt. cm. 3	
51402	Lettere e numeri alt. cm. 4	
51502	Lettere e numeri alt. cm. 5	
51602	Lettere e numeri alt. cm. 6	
51802	Lettere e numeri alt. cm. 8	
51102	Lettere e numeri alt. cm. 10	
53000	Punteggiatura	
ELEGANT TRAFORATO INOX sp. mm. 3		pag. 298
54152	Lettere e numeri alt. cm. 1,5	
54202	Lettere e numeri alt. cm. 2	
54252	Lettere e numeri alt. cm. 2,5	
54302	Lettere e numeri alt. cm. 3	
54402	Lettere e numeri alt. cm. 4	
54502	Lettere e numeri alt. cm. 5	
54602	Lettere e numeri alt. cm. 6	
54802	Lettere e numeri alt. cm. 8	
54102	Lettere e numeri alt. cm. 10	
53000	Punteggiatura	
PRESTIGE TRAFORATO INOX sp. mm. 3		pag. 298
53151	Lettere e numeri alt. cm. 1,5	
53201	Lettere e numeri alt. cm. 2	
53251	Lettere e numeri alt. cm. 2,5	
53301	Lettere e numeri alt. cm. 3	
53401	Lettere e numeri alt. cm. 4	
53501	Lettere e numeri alt. cm. 5	
53601	Lettere e numeri alt. cm. 6	
53801	Lettere e numeri alt. cm. 8	
53101	Lettere e numeri alt. cm. 10	
53000	Punteggiatura	
INCISIONE SU PORTAFOTO		
INCISIONE a richiesta su SOFFIO e TEMPO		
EPIGRAFI SU LIBRI E PERGAMENE		
	Incisione in carattere corsivo, bastone o romano alla lettera (sc. 50% per q.tà superiore alle 40 lettere)	
	Applicazione in carattere bastone alla lettera	

OGGETTISTICA ORNAMENTALE

Codice Articolo	Descrizione	Pagina	Accessorio	
			Descrizione	Codice
1				
P 1 011/25P	Vaso	15	Int. Plastica	97 051
P 1 011/13P	Vaso	173,186,544	Int. Plastica	97 019
P 1 011/21P	Vaso	173	Int. Plastica	97 010
P 1 013/9	Vaso	540	Int. Alluminio	96 018
P 1 019/13P	Vaso	69,536	Int. Plastica	97 431
P 1 019/20R	Vaso	69	Int. Alluminio	96 003
P 1 020/20R	Vaso	45	Int. Rame	96 031
P 1 021/13P	Vaso	114	Int. Plastica	97 019
P 1 021/21P	Vaso	114	Int. Plastica	97 010
P 1 030/20R	Vaso	24	Int. Rame	96 521
T 1 032/20R	Vaso	24	Int. Rame	96 521
T 1 032/25R	Vaso	24	Int. Rame	96 205
P 1 034/13P	Vaso	42,537	Int. Plastica	97 019
P 1 034/20R	Vaso	42	Int. Rame	96 031
P 1 035/11	Vaso	102,538	Int. Plastica	97 019
T 1 037/20R	Vaso	69	Int. Alluminio	96 003
P 1 038/20R	Vaso	25	Int. Rame	96 521
P 1 039 /13P	Vaso	113	Int. Plastica	97 019
P 1 039/21P	Vaso	113	Int. Plastica	97 010
T 1 040/20R	Vaso	25	Int. Rame	96 521
T 1 040/25R	Vaso	25	Int. Rame	96 205
P 1 041/13P	Vaso	116	Int. Plastica	97 019
P 1 041/21P	Vaso	116	Int. Plastica	97 010
P 1 042/20R	Vaso	44	Int. Rame	96 031
P 1 043/13P	Vaso	115	Int. Plastica	97 019
P 1 043/21P	Vaso	115	Int. Plastica	97 010
P 1 044/13P	Vaso	112	Int. Plastica	97 019
P 1 044/21P	Vaso	112	Int. Plastica	97 010
P 1 045/20R	Vaso	82	Int. Alluminio	96 003
T 1 046/11	Vaso	102,538	Int. Plastica	97 019
P 1 047/25P	Vaso	17	Int. Plastica	97 051
T 1 050/20R	Vaso	82	Int. Alluminio	96 003
T 1 050/30R	Vaso	82	Int. Alluminio	96 057
P 1 051 /13P	Vaso	118	Int. Plastica	97 019
P 1 051/21P	Vaso	118	Int. Plastica	97 010
P 1 052/13P	Vaso	70,536	Int. Plastica	97 431
P 1 052/20R	Vaso	70	Int. Alluminio	96 003
P 1 053/25P	Vaso	19	Int. Plastica	97 051
P 1 055/13P	Vaso	117	Int. Plastica	97 019
P 1 055/21P	Vaso	117	Int. Plastica	97 010
P 1 057/12	Vaso	101,539	Int. Alluminio	96 052
P 1 059/13P	Vaso	111	Int. Plastica	97 019
P 1 059/21P	Vaso	111	Int. Plastica	97 010
P 1 060/20R	Vasca	82	Int. Rame	96 030
P 1 062/13P	Vaso	119	Int. Plastica	97 019
P 1 062/21P	Vaso	119	Int. Plastica	97 010
T 1 065/20R	Vaso	70	Int. Alluminio	96 003
T 1 068/12	Vaso	101,539	Int. Alluminio	96 052
T 1 070/20R	Vasca	82	Int. Rame	96 030
P 1 073/13P	Vaso	172,186,536	Int. Plastica	97 431
P 1 073/20R	Vaso	172	Int. Alluminio	96 003
T 1 085/20R	Vaso	172	Int. Alluminio	96 003
P 1 087/13P	Vaso	71,536	Int. Plastica	97 431
P 1 087/20R	Vaso	71	Int. Alluminio	96 003
P 1 089/25P	Vaso	21	Int. Plastica	97 051
T 1 100/20R	Vaso	42	Int. Rame	96 031
T 1 100/25R	Vaso	42	Int. Rame	96 246
P 1 104/20R	Vaso	151	Int. Alluminio	96 055
T 1 105/20R	Vaso	151	Int. Alluminio	96 055
P 1 106/20R	Vasca	151	Int. Rame	96 047
T 1 107/20R	Vasca	151	Int. Rame	96 047
P 1 108/13P	Vaso	73,538	Int. Plastica	97 019
P 1 108/21P	Vaso	73	Int. Plastica	97 010
P 1 110/20	Vaso	32	Int. Rame	96 031
T 1 111/20	Vaso	32	Int. Rame	96 031
P 1 112/18	Vasca	32	Int. Rame	96 064

OGGETTISTICA ORNAMENTALE

Codice Articolo	Descrizione	Pagina	Accessorio	
			Descrizione	Codice
T 1 113/18	Vasca	32	Int. Rame	96 064
T 1 114/20R	Vasca	152	Int. Rame	96 047
P 1 117/13R	Vaso	152,159,543	Int. Alluminio	96 641
P 1 117/20R	Vaso	152	Int. Alluminio	96 055
T 1 118/20R	Vaso	152	Int. Alluminio	96 055
P 1 119/20R	Vasca	152	Int. Rame	96 047
P 1 120/13P	Vaso	84,538	Int. Plastica	97 019
P 1 120/20R	Vaso	84	Int. Alluminio	96 003
T 1 121/20R	Vaso	44	Int. Rame	96 031
T 1 121/25R	Vaso	44	Int. Rame	96 246
T 1 122/21P	Vaso	73	Int. Plastica	97 010
T 1 122/28P	Vaso	73	Int. Plastica	97 032
P 1 123/19R	Vasca	84	Int. Rame	96 005
P 1 124/13P	Vaso	150,159,543	Int. Plastica	97 019
P 1 124/20R	Vaso	150	Int. Alluminio	96 055
T 1 125/20R	Vaso	84	Int. Alluminio	96 003
T 1 127/20R	Vaso	83	Int. Alluminio	96 003
T 1 127/29P	Vaso	83	Int. Plastica	97 065
P 1 128/13P	Vaso	83,538	Int. Plastica	97 019
P 1 128/20R	Vaso	83	Int. Alluminio	96 003
P 1 129/19R	Vasca	83	Int. Rame	96 005
T 1 130/19R	Vasca	83	Int. Rame	96 005
T 1 131/20R	Vaso	150	Int. Alluminio	96 055
P 1 134/13R	Vaso	540	Int. Alluminio	96 350
T 1 135/19R	Vasca	84	Int. Rame	96 005
P 1 139/19R	Vasca	150	Int. Rame	96 026
P 1 140/13P	Vaso	191,197,545	Int. Plastica	97 019
P 1 140/20R	Vaso	191	Int. Alluminio	96 055
T 1 142/19R	Vasca	150	Int. Rame	96 026
P 1 143/20R	Vaso	43	Int. Rame	96 031
T 1 145/20R	Vaso	191	Int. Alluminio	96 055
P 1 148/19R	Vasca	191	Int. Rame	96 026
T 1 150/19R	Vasca	191	Int. Rame	96 026
P 1 152/13P	Vaso	149,159,543	Int. Plastica	97 019
P 1 152/21P	Vaso	149	Int. Plastica	97 010
P 1 157/13P	Vaso	125,137,542	Int. Plastica	97 019
P 1 157/21P	Vaso	125	Int. Plastica	97 010
P 1 170/13R	Vaso	81,540	Int. Alluminio	96 645
P 1 170/20R	Vaso	80	Int. Alluminio	96 003
T 1 180/13R	Vaso	81,540	Int. Alluminio	96 645
T 1 180/20R	Vaso	80	Int. Alluminio	96 003
T 1 180/30R	Vaso	81	Int. Alluminio	96 049
T 1 185/20R	Vaso	43	Int. Rame	96 031
T 1 185/25R	Vaso	43	Int. Rame	96 246
P 1 196/20R	Vasca	80	Int. Rame	96 030
T 1 200/20R	Vasca	80	Int. Rame	96 030
P 1 210/13R	Vaso	540	Int. Alluminio	96 660
P 1 215/09P	Vasca	42,537	Int. Plastica	96 022
P 1 215/18R	Vasca	42	Int. Rame	96 064
P 1 219/18R	Vasca	45	Int. Rame	96 064
P 1 227/18R	Vasca	44	Int. Rame	96 064
P 1 252/16	Vasca	63	Int. Rame	96 064
P 1 260/18R	Vasca	43	Int. Rame	96 064
P 1 270/13R	Vaso	539	Int. Alluminio	96 052
T 1 280/18R	Vasca	42	Int. Rame	96 064
T 1 285/18R	Vasca	44	Int. Rame	96 064
T 1 298/18R	Vasca	43	Int. Rame	96 064
P 1 319/20	Vaso	63	Int. Rame	96 042
P 1 408 /13	Semivaso	73,121		
P 1 408 /21	Semivaso	73,121	Int. Plastica	97 029
P 1 412/20	Vaso	65	Int. Plastica	97 012
P 1 415 /13	Semivaso	114,121		
P 1 415 /21	Semivaso	114,121	Int. Plastica	97 029
P 1 420/20P	Vaso	85	Int. Plastica	97 010
P 1 421/20P	Vaso	156	Int. Plastica	97 010
P 1 425 /13	Semivaso	113,121		
P 1 425/21	Semivaso	113,121	Int. Plastica	97 029
P 1 431/13	Semivaso	116,121		

OGGETTISTICA ORNAMENTALE

	Codice Articolo	Descrizione	Pagina	Accessorio	
				Descrizione	Codice
P	1 431 /21	Semivaso	116,121	Int. Plastica	97 029
P	1 440/20P	Vaso	128	Int. Plastica	97 010
P	1 452/13	Semivaso	121,173		
P	1 452/21	Semivaso	121,173	Int. Plastica	97 029
P	1 455/13	Semivaso	115,121		
P	1 455/21	Semivaso	115,121	Int. Plastica	97 029
P	1 472/13	Semivaso	112,121		
P	1 472/21	Semivaso	112,121	Int. Plastica	97 029
P	1 473 /13	Semivaso	121,125		
P	1 473/21	Semivaso	121,125	Int. Plastica	97 029
P	1 480/13	Semivaso	118,121		
P	1 480/21	Semivaso	118,121	Int. Plastica	97 029
P	1 485/13	Semivaso	117,121		
P	1 485/21	Semivaso	117,121	Int. Plastica	97 029
P	1 490/13	Semivaso	111,121		
P	1 490/21	Semivaso	111,121	Int. Plastica	97 029
P	1 493/13	Semivaso	119,121		
P	1 493/21	Semivaso	119,121	Int. Plastica	97 029
P	1 496/13	Semivaso	121,149		
P	1 496/21	Semivaso	121,149	Int. Plastica	97 029
P	1 520/13P	Vaso	126,137,542	Int. Plastica	97 019
P	1 520/20R	Vaso	126	Int. Alluminio	96 003
P	1 527/19R	Vasca	126	Int. Rame	96 005
P	1 530/13P	Vaso	168,545	Int. Plastica	97 019
P	1 530/20R	Vaso	168	Int. Alluminio	96 003
T	1 535/20R	Vaso	168	Int. Alluminio	96 003
P	1 538/19R	Vasca	168	Int. Rame	96 005
P	1 539/20R	Vaso	46	Int. Rame	96 031
T	1 540/20R	Vaso	126	Int. Alluminio	96 003
T	1 543/19R	Vasca	168	Int. Rame	96 005
T	1 550/19R	Vasca	126	Int. Rame	96 005
P	1 560/20R	Vaso	47	Int. Rame	96 031
T	1 570/20R	Vaso	46	Int. Rame	96 031
T	1 570/30R	Vaso	46	Int. Rame	96 242
P	1 593/14	Vasca	104	Interno	96 144
T	1 620/20R	Vaso	47	Int. Rame	96 031
T	1 620/30R	Vaso	47	Int. Rame	96 242
P	1 673/18	Vaso	108	Int. Alluminio	96 155
P	1 695/18	Vaso	108	Int. Alluminio	96 155
P	1 731/15	Vaso	109	Int. Rame	96 166
P	1 753/21	Vaso	109	Int. Rame	96 166
T	1 764/23	Vaso	108	Int. Rame	96 166
P	1 775/17	Vaso	109	Int. Rame	96 177
P	1 775/20	Vaso	109	Int. Rame	96 166
P	1 775/25	Vaso	109	Int. Rame	96 188
T	1 786/15	Vaso	108	Int. Rame	96 177
T	1 786/20	Vaso	108	Int. Rame	96 166
T	1 786/25	Vaso	108	Int. Rame	96 188
P	1 833/20	Vaso	109	Int. Rame	96 199
P	1 979/20	Vaso	65	Int. Rame	96 031
P	1 980/19R	Vasca	46	Int. Rame	96 030

2

P	2 000/13	Portaorchidea	541	Int. Plastica	97 026
P	2 004/18P	Vasca	114	Int. Plastica	97 005
P	2 010/14	Portaorchidea	541	Int. Alluminio	96 450
P	2 011/18P	Vasca	113	Int. Plastica	97 005
P	2 017 /18P	Vasca	116	Int. Plastica	97 005
P	2 020/19R	Vasca	47	Int. Rame	96 030
P	2 022/18P	Vasca	115	Int. Plastica	97 005
T	2 030/19R	Vasca	46	Int. Rame	96 030
P	2 031/18P	Vasca	73	Int. Plastica	97 005
P	2 035 /18P	Vasca	112	Int. Plastica	97 005
P	2 038/18P	Vasca	118	Int. Plastica	97 005
P	2 040/18P	Vasca	117	Int. Plastica	97 005
P	2 041/18P	Vasca	119	Int. Plastica	97 005
P	2 042/18P	Vasca	111	Int. Plastica	97 005

OGGETTISTICA ORNAMENTALE

	Codice Articolo	Descrizione	Pagina	Accessorio	
				Descrizione	Codice
T	2 048/18P	Vasca	73	Int. Plastica	97 005
P	2 050/18R	Vasca	69	Int. Rame	96 005
T	2 060/19R	Vasca	47	Int. Rame	96 030
T	2 065/18R	Vasca	69	Int. Rame	96 005
P	2 074/18R	Vasca	70	Int. Rame	96 005
P	2 078/18P	Vasca	125	Int. Plastica	97 005
P	2 085/18P	Vasca	149	Int. Plastica	97 005
T	2 091/18R	Vasca	70	Int. Rame	96 005
P	2 101/13	Vaso	154,159,543	Int. Alluminio	96 641
P	2 101/20	Vaso	154	Int. Alluminio	96 758
P	2 107/17	Vasca	58	Int. Rame	96 064
T	2 112/13	Vaso	154,159,543	Int. Alluminio	96 641
T	2 112/20	Vaso	154	Int. Alluminio	96 758
T	2 113/18P	Vasca	173	Int. Plastica	97 005
T	2 118/17	Vasca	58	Int. Rame	96 064
P	2 120/18R	Vasca	172	Int. Rame	96 005
P	2 123/19	Vasca	154	Int. Rame	96 026
T	2 125/19	Vasca	154	Int. Rame	96 026
P	2 140/13P	Vaso	89,538	Int. Plastica	97 431
P	2 140/13R	Vaso	89,538	Int. Alluminio	96 645
P	2 140/18P	Vaso	88	Int. Plastica	97 122
P	2 140/18R	Vaso	88	Int. Alluminio	96 068
P	2 140/20P	Vaso	88	Int. Plastica	97 112
P	2 140/20R	Vaso	88	Int. Alluminio	96 059
T	2 142/13R	Vaso	89,538	Int. Alluminio	96 645
T	2 142/18P	Vaso	88	Int. Plastica	97 122
T	2 142/18R	Vaso	88	Int. Alluminio	96 068
T	2 142/20P	Vaso	88	Int. Plastica	97 112
T	2 142/20R	Vaso	88	Int. Alluminio	96 059
T	2 142/30P	Vaso	89	Int. Plastica	97 065
T	2 142/30R	Vaso	89	Int. Alluminio	96 057
T	2 144/18R	Vasca	172	Int. Rame	96 005
P	2 146/19P	Vasca	88	Int. Plastica	97 021
P	2 146/19R	Vasca	88	Int. Rame	96 005
T	2 148/19P	Vasca	88	Int. Plastica	97 021
T	2 148/19R	Vasca	88	Int. Rame	96 005
P	2 153/13R	Vaso	175,186,544	Int. Alluminio	96 641
P	2 153/20R	Vaso	175	Int. Alluminio	96 758
T	2 155/20R	Vaso	175	Int. Alluminio	96 758
P	2 157/19R	Vasca	175	Int. Rame	96 026
P	2 158 /18R	Vasca	71	Int. Rame	96 005
T	2 159/19R	Vasca	175	Int. Rame	96 026
P	2 172/18R	Vasca	24	Int. Rame	96 452
P	2 173/16	Vasca	52	Int. Rame	96 064
P	2 178/13P	Vaso	137,542	Int. Plastica	97 431
P	2 181/19	Vaso	54	Int. Rame	96 031
P	2 183/19	Vaso	146	Int. Alluminio	96 055
P	2 184/20R	Vaso	153	Int. Alluminio	96 758
T	2 185/20R	Vaso	153	Int. Alluminio	96 758
P	2 186/18R	Vasca	153	Int. Rame	96 026
T	2 187/18R	Vasca	153	Int. Rame	96 026
T	2 189/18R	Vasca	24	Int. Rame	96 452
P	2 190/19	Vaso	130	Int. Alluminio	96 003
P	2 191/19	Vaso	167	Int. Alluminio	96 523
P	2 192/13P	Vaso	123,137,536	Int. Plastica	97 431
P	2 192/20R	Vaso	123	Int. Alluminio	96 003
P	2 194/16	Vasca	130	Int. Rame	96 064
P	2 195/19	Vaso	52	Int. Rame	96 031
P	2 200/18R	Vasca	25	Int. Rame	96 452
T	2 201/19	Vaso	130	Int. Alluminio	96 003
T	2 207/19	Vaso	52	Int. Rame	96 031
T	2 216/18R	Vasca	25	Int. Rame	96 452
P	2 218/15	Vasca	53	Int. Rame	96 064
T	2 223/19	Vaso	54	Int. Rame	96 031
T	2 223/29	Vaso	54	Int. Rame	96 496
T	2 225/19	Vaso	146	Int. Alluminio	96 055
P	2 229/20R	Vaso	134	Int. Alluminio	96 003
P	2 234/20R	Vaso	76	Int. Alluminio	96 003

OGGETTISTICA ORNAMENTALE

Codice Articolo	Descrizione	Pagina	Accessorio	
			Descrizione	Codice
P 2 236/20R	Vaso	78	Int. Alluminio	96 003
P 2 238/20R	Vaso	177	Int. Alluminio	96 055
P 2 239/20R	Vaso	148	Int. Alluminio	96 055
P 2 240/20R	Vaso	194	Int. Alluminio	96 055
T 2 244/20R	Vaso	76	Int. Alluminio	96 003
T 2 244/30R	Vaso	77	Int. Rame	96 496
T 2 245/20R	Vaso	78	Int. Alluminio	96 003
T 2 245/30R	Vaso	79	Int. Alluminio	96 058
T 2 247/20R	Vaso	177	Int. Alluminio	96 055
T 2 250/20R	Vaso	134	Int. Alluminio	96 003
P 2 251/18R	Vasca	123	Int. Rame	96 005
T 2 257/20R	Vaso	194	Int. Alluminio	96 055
P 2 297/17	Vasca	62	Int. Rame	96 064
P 2 302/20P	Vasca	15	Int. Plastica	97 021
P 2 311/19	Vaso	62	Int. Rame	96 042
P 2 313/20P	Vasca	17	Int. Plastica	97 021
P 2 324/20P	Vasca	19	Int. Plastica	97 021
P 2 333/17	Vasca	62	Int. Rame	96 064
P 2 341/20	Vaso	94	Int. Alluminio	96 003
P 2 347/20P	Vaso	92	Int. Plastica	97 442
P 2 349/20P	Vaso	180	Int. Plastica	97 444
P 2 350/20R	Vaso	195	Int. Alluminio	96 055
P 2 357/20R	Vasca	21	Int. Plastica	97 024
T 2 401/20P	Vaso	92	Int. Plastica	97 442
T 2 401/30P	Vaso	93	Int. Plastica	97 464
T 2 403/20	Vaso	94	Int. Alluminio	96 003
T 2 403/30	Vaso	95	Int. Rame	96 496
T 2 405/20P	Vaso	180	Int. Plastica	97 444
T 2 407/20R	Vaso	195	Int. Alluminio	96 055
P 2 430/20P	Vasca	85	Int. Plastica	97 035
P 2 438/20P	Vasca	156	Int. Plastica	97 035
P 2 440/20P	Vasca	128	Int. Plastica	97 035
T 2 470/16	Portaorchidea	541	Int. Alluminio	96 450
P 2 480/10	Vaso	541	Int. Alluminio	96 100
P 2 559/19R	Vaso	105	Int. Alluminio	96 003
T 2 561/19R	Vaso	105	Int. Alluminio	96 003
P 2 570/13R	Vaso	539	Int. Alluminio	96 350
P 2 572/19R	Vaso	105	Int. Alluminio	96 003
P 2 580/18	Vasca	167	Int. Rame	96 454
T 2 583/19R	Vaso	105	Int. Alluminio	96 003
P 2 595/18	Vasca	54	Int. Rame	96 064
P 2 597/18	Vasca	146	Int. Rame	96 452
P 2 620/13R	Vaso	538	Int. Alluminio	96 350
T 2 792/18	Vasca	54	Int. Rame	96 064
T 2 794/18	Vasca	146	Int. Rame	96 452
P 2 812/16	Vasca	65	Int. Rame	96 634
P 2 904/12P	Portaorchidea	173,186,544	Int. Plastica	97 026
P 2 910/12P	Portaorchidea	114	Int. Plastica	97 026
P 2 927/12	Portaorchidea	186,544		
P 2 928/12P	Portaorchidea	73,540	Int. Plastica	97 026
P 2 931/10	Portaorchidea	159,543		
P 2 933/12P	Portaorchidea	113	Int. Plastica	97 026
P 2 935/12	Portaorchidea	137,542		
P 2 936/10	Portaorchidea	541		
P 2 937/12P	Portaorchidea	116	Int. Plastica	97 026
P 2 940/12	Portaorchidea	137,542	Int. Plastica	97 026
P 2 942/12	Portaorchidea	186,544	Int. Plastica	97 026
P 2 943/12	Portaorchidea	541	Int. Plastica	97 026
P 2 945/12	Portaorchidea	541	Int. Plastica	97 026
P 2 951/12	Portaorchidea	159,543	Int. Plastica	97 026
P 2 952/12	Portaorchidea	137,542	Int. Plastica	97 026
P 2 955/12P	Portaorchidea	115	Int. Plastica	97 026
P 2 956/12P	Portaorchidea	149,159,543	Int. Plastica	97 026
P 2 957/12	Portaorchidea	186,544	Int. Plastica	97 026
P 2 958/10	Portaorchidea	541		
P 2 961/12P	Portaorchidea	125,137,542	Int. Plastica	97 026
P 2 962/12P	Portaorchidea	112	Int. Plastica	97 026
P 2 964/12P	Portaorchidea	118	Int. Plastica	97 026

OGGETTISTICA ORNAMENTALE

Codice Articolo	Descrizione	Pagina	Accessorio	
			Descrizione	Codice
P 2 967/12P	Portaorchidea	117	Int. Plastica	97 026
P 2 970/18	Vasca	131	Int. Rame	96 005
P 2 971/10	Portaorchidea	193,197,545		
P 2 974/20	Vaso	131	Int. Alluminio	96 059
P 2 975/12	Portaorchidea	541	Int. Plastica	97 026
P 2 977/12	Portaorchidea	159,543	Int. Plastica	97 026
P 2 978/20	Vaso	124	Int. Alluminio	96 003
P 2 979/17	Vasca	124	Int. Rame	96 064
P 2 980/20	Vasca	136	Int. Plastica	97 495
P 2 987/20R	Vaso	127	Int. Alluminio	96 003
T 2 988/20R	Vaso	127	Int. Alluminio	96 003
P 2 989/17R	Vasca	127	Int. Rame	96 005
T 2 990/17R	Vasca	127	Int. Rame	96 005
T 2 991/20	Vaso	124	Int. Alluminio	96 003
T 2 992/17	Vasca	124	Int. Rame	96 064
T 2 994/20	Vaso	131	Int. Alluminio	96 059
P 2 996/12P	Portaorchidea	111	Int. Plastica	97 026
P 2 998/12P	Portaorchidea	119	Int. Plastica	97 026
T 2 999/18	Vasca	131	Int. Rame	96 005

4

P 4 001/17	Vasca	39	Int. Rame	96 064
P 4 010/13	Vaso	27,537	Int. Rame	96 029
P 4 010/20	Vaso	26	Int. Rame	96 031
P 4 013/20P	Vaso	104	Int. Plastica	97 012
P 4 015/20P	Vaso	181	Int. Plastica	97 012
P 4 019/20P	Vaso	135	Int. Plastica	97 012
T 4 021/30	Vaso	27	Int. Rame	96 242
P 4 025/19	Vasca	99	Int. Plastica	97 021
P 4 032/20P	Vaso	106	Int. Plastica	97 012
T 4 036/19	Vasca	99	Int. Plastica	97 021
P 4 040/21	Vaso	249		
P 4 202/18	Vasca	104	Int. Plastica	97 014
P 4 204/18	Vasca	181	Int. Plastica	97 014
P 4 207/18P	Vasca	135	Int. Plastica	97 014
P 4 211/20	Vaso	56	Int. Rame	96 031
P 4 213/20	Vaso	178	Int. Alluminio	96 055
T 4 222/20	Vaso	56	Int. Rame	96 031
T 4 225/20	Vaso	178	Int. Alluminio	96 055
P 4 228/18	Vasca	106	Int. Plastica	97 014
P 4 233/17	Vasca	56	Int. Rame	96 064
P 4 235/17	Vasca	178	Int. Rame	96 452
P 4 237/19	Vasca	26	Int. Rame	96 064
T 4 244/17	Vasca	56	Int. Rame	96 064
T 4 246/17	Vasca	178	Int. Rame	96 452
P 4 250/19R	Vasca	148	Int. Rame	96 026
P 4 251/19R	Vasca	78	Int. Rame	96 005
P 4 253/19R	Vasca	76	Int. Rame	96 005
P 4 254/19R	Vasca	194	Int. Rame	96 026
P 4 256/19R	Vasca	134	Int. Rame	96 005
P 4 257/19R	Vasca	177	Int. Rame	96 026
T 4 260/19R	Vasca	134	Int. Rame	96 005
T 4 262/19R	Vasca	76	Int. Rame	96 005
T 4 263/19R	Vasca	78	Int. Rame	96 005
T 4 268/19R	Vasca	177	Int. Rame	96 026
T 4 269/19R	Vasca	194	Int. Rame	96 026
P 4 275/17	Vasca	98	Int. Plastica	97 021
P 4 278/19	Vasca	98	Int. Plastica	97 006
T 4 286/17	Vasca	98	Int. Plastica	97 021
P 4 315/17	Vasca	181	Int. Plastica	97 014
P 4 318/17	Vasca	104	Int. Plastica	97 014
P 4 326/17R	Vasca	77	Int. Rame	96 005
P 4 328/17R	Vasca	79	Int. Rame	96 005
P 4 354/19	Vasca	94	Int. Rame	96 005
P 4 355/19P	Vasca	92	Int. Plastica	97 021
P 4 359/19P	Vasca	180	Int. Plastica	97 024
P 4 360/19R	Vasca	195	Int. Rame	96 026

OGGETTISTICA ORNAMENTALE

	Codice Articolo	Descrizione	Pagina	Accessorio	
				Descrizione	Codice
T	4 361/19P	Vasca	92	Int. Plastica	97 021
T	4 365/19P	Vasca	180	Int. Plastica	97 024
T	4 366/19	Vasca	94	Int. Rame	96 005
T	4 370/19R	Vasca	195	Int. Rame	96 026
P	4 415/19	Vaso	102	Int. Alluminio	96 003
P	4 424/17P	Vasca	93	Int. Plastica	97 021
T	4 426/19	Vaso	102	Int. Alluminio	96 003
T	4 435/17P	Vasca	93	Int. Plastica	97 021
P	4 437/15	Vasca	102	Int. Rame	96 005
P	4 517/20	Vaso	101	Int. Alluminio	96 068
T	4 528/20	Vaso	101	Int. Alluminio	96 068
T	4 528/29	Vaso	101	Int. Plastica	97 464
T	4 528/34	Vaso	101	Int. Alluminio	96 057
T	4 528/40	Vaso	101	Int. Alluminio	96 224
P	4 552/20	Vaso	59	Int. Rame	96 235
T	4 563/20	Vaso	59	Int. Rame	96 235
T	4 563/24	Vaso	59	Int. Rame	96 246
T	4 563/30	Vaso	59	Int. Rame	96 257
T	4 563/38	Vaso	59	Int. Rame	96 281
T	4 563/50	Vaso	59	Int. Rame	96 279
P	4 568/20	Vasca	196	Int. Plastica	97 495
P	4 570/20	Vasca	107	Int. Plastica	97 495
P	4 574/18	Vasca	59	Int. Rame	96 005
P	4 577/20	Vasca	136	Int. Plastica	97 495
P	4 578/19	Vasca	182	Int. Plastica	97 495
P	4 579/19	Vasca	182	Int. Plastica	97 495
P	4 580/20	Vasca	196	Int. Plastica	97 495
P	4 581/19	Vasca	158	Int. Plastica	97 495
T	4 585/18	Vasca	59	Int. Rame	96 005
P	4 590/20	Vasca	169	Int. Plastica	97 495
P	4 592/20	Vasca	107	Int. Plastica	97 495
P	4 601/21	Vasca	106	Int. Plastica	97 495
P	4 603/21	Vasca	136	Int. Plastica	97 495
P	4 605/21	Vasca	158	Int. Plastica	97 495
P	4 607/21	Vasca	182	Int. Plastica	97 495
T	4 608/55	Vaso	59	Int. Rame	96 279
P	4 619/20	Vaso	61	Int. Rame	96 235
T	4 621/20	Vaso	61	Int. Rame	96 235
T	4 621/30	Vaso	61	Int. Rame	96 257
T	4 621/38	Vaso	61	Int. Rame	96 281
T	4 621/50	Vaso	61	Int. Rame	96 279
P	4 632/18	Vasca	61	Int. Rame	96 005
T	4 643/18	Vasca	61	Int. Rame	96 005
T	4 665/55	Vaso	61	Int. Rame	96 279
P	4 676/20	Vaso	60	Int. Rame	96 235
T	4 687/20	Vaso	60	Int. Alluminio	96 059
T	4 687/30	Vaso	60	Int. Alluminio	96 057
P	4 695/13P	Vaso	159,543	Int. Plastica	97 431
P	4 698/13	Vaso	100,539	Int. Plastica	97 431
P	4 698/19P	Vaso	100	Int. Plastica	97 112
P	4 698/19R	Vaso	100	Int. Alluminio	96 292
T	4 701/13	Vaso	100,539	Int. Plastica	97 431
T	4 701/19P	Vaso	100	Int. Plastica	97 112
T	4 701/19R	Vaso	100	Int. Alluminio	96 292
T	4 701/28	Vaso	100	Int. Plastica	97 064
P	4 712/22	Vaso	29	Int. Rame	96 031
T	4 745/30	Vaso	53	Int. Plastica	97 065
P	4 756/18	Vaso	58	Int. Rame	96 133
P	4 756/22	Vaso	58	Int. Rame	96 031
T	4 767/18	Vaso	58	Int. Rame	96 133
T	4 767/22	Vaso	58	Int. Rame	96 031
T	4 767/28	Vaso	58	Int. Plastica	97 032
P	4 893/18P	Vasca	86	Int. Plastica	97 021
P	4 893/18R	Vasca	86	Int. Rame	96 005
P	4 895/18R	Vasca	174	Int. Rame	96 026
P	4 896/18	Vasca	87	Int. Rame	96 005
P	4 897/18R	Vasca	129	Int. Rame	96 005
T	4 903/18R	Vasca	174	Int. Rame	96 026

OGGETTISTICA ORNAMENTALE

	Codice Articolo	Descrizione	Pagina	Accessorio	
				Descrizione	Codice
T	4 905/18P	Vasca	86	Int. Plastica	97 021
T	4 905/18R	Vasca	86	Int. Rame	96 005
T	4 907/18	Vasca	87	Int. Rame	96 005
P	4 911/18	Vasca	155	Int. Rame	96 026
T	4 922/18	Vasca	155	Int. Rame	96 026

5

P	5 001/20	Vaso	99	Int. Plastica	97 442
T	5 010/20	Vaso	99	Int. Plastica	97 442
T	5 010/30	Vaso	99	Int. Plastica	97 464
P	5 014/12	Vaso	537	Int. Alluminio	96 052
P	5 041/20	Vaso	30	Int. Rame	96 031
T	5 043/20	Vaso	30	Int. Rame	96 031
P	5 045/19	Vasca	30	Int. Rame	96 064
T	5 047/19	Vasca	30	Int. Rame	96 064
P	5 060/20	Vaso	31	Int. Rame	96 031
P	5 064/19	Vasca	31	Int. Rame	96 064
P	5 071/20P	Vaso	90	Int. Plastica	97 112
P	5 071/20R	Vaso	90	Int. Alluminio	96 059
P	5 073/18P	Vasca	90	Int. Plastica	97 021
P	5 073/18R	Vasca	90	Int. Rame	96 005
T	5 092/20P	Vaso	90	Int. Plastica	97 112
T	5 092/20R	Vaso	90	Int. Alluminio	96 059
T	5 092/29P	Vaso	90	Int. Plastica	97 464
T	5 092/29R	Vaso	90	Int. Rame	96 496
T	5 094/18P	Vasca	90	Int. Plastica	97 021
T	5 094/18R	Vasca	90	Int. Rame	96 005
P	5 101/12	Vaso	39,537	Int. Plastica	97 026
P	5 101/20	Vaso	38	Int. Rame	96 031
P	5 103/17	Vasca	38	Int. Rame	96 064
P	5 105/20	Vaso	40	Int. Rame	96 031
T	5 112/20	Vaso	38	Int. Rame	96 031
T	5 112/29	Vaso	39	Int. Rame	96 242
T	5 114/17	Vasca	38	Int. Rame	96 064
T	5 116/20	Vaso	40	Int. Rame	96 031
T	5 116/29	Vaso	40	Int. Rame	96 242
P	5 124/17	Vasca	40	Int. Rame	96 064
P	5 126/17	Vasca	41	Int. Rame	96 064
T	5 136/17	Vasca	40	Int. Rame	96 064
T	5 138/17	Vasca	41	Int. Rame	96 064
P	5 140/23	Vaso	33	Int. Rame	96 064
P	5 146/28	Vasca	33	Int. Rame	96 064
P	5 176/19	Vaso	55	Int. Rame	96 031
P	5 178/20	Vaso	41	Int. Rame	96 031
T	5 187/19	Vaso	55	Int. Rame	96 031
T	5 187/29	Vaso	55	Int. Rame	96 496
T	5 189/20	Vaso	41	Int. Rame	96 031
P	5 198/18	Vasca	55	Int. Rame	96 064
P	5 275/12	Vaso	98,539	Int. Plastica	97 019
P	5 275/19	Vaso	98	Int. Plastica	97 442
P	5 312/13	Vaso	176,186,544	Int. Alluminio	96 601
P	5 312/20	Vaso	176	Int. Alluminio	96 055
P	5 314/13	Vaso	75,539	Int. Alluminio	96 052
P	5 314/18	Vaso	74	Int. Alluminio	96 066
P	5 314/20	Vaso	74	Int. Alluminio	96 003
P	5 314/26	Vaso	75	Int. Alluminio	96 056
P	5 314/30	Vaso	75	Int. Rame	96 496
T	5 323/20	Vaso	176	Int. Alluminio	96 055
T	5 325/13	Vaso	75,539	Int. Alluminio	96 052
T	5 325/18	Vaso	74	Int. Alluminio	96 066
T	5 325/20	Vaso	74	Int. Alluminio	96 003
T	5 325/26	Vaso	75	Int. Alluminio	96 056
T	5 325/28	Vaso	75	Int. Alluminio	96 058
T	5 325/35	Vaso	75	Int. Alluminio	96 057
P	5 332/16	Vasca	176	Int. Rame	96 026
P	5 336/16	Vasca	74	Int. Rame	96 005
T	5 341/16	Vasca	176	Int. Rame	96 026

OGGETTISTICA ORNAMENTALE

	Codice Articolo	Descrizione	Pagina	Accessorio	
				Descrizione	Codice
T	5 347/16	Vasca	74	Int. Rame	96 005
P	5 358/16	Vasca	75	Int. Rame	96 005
T	5 370/12	Vaso	98,539	Int. Plastica	97 019
T	5 370/19	Vaso	98	Int. Plastica	97 442
T	5 370/28	Vaso	98	Int. Plastica	97 464
T	5 381/29	Vaso	65	Int. Plastica	97 464
P	5 430/20P	Vaso	97	Int. Plastica	97 442
P	5 430/20R	Vaso	97	Int. Alluminio	96 003
T	5 432/20P	Vaso	97	Int. Plastica	97 442
T	5 432/20R	Vaso	97	Int. Alluminio	96 003
T	5 432/29P	Vaso	97	Int. Plastica	97 464
T	5 432/29R	Vaso	97	Int. Rame	96 496
P	5 440/18P	Vasca	97	Int. Plastica	97 021
P	5 440/18R	Vasca	97	Int. Rame	96 005
T	5 442/18P	Vasca	97	Int. Plastica	97 021
T	5 442/18R	Vasca	97	Int. Rame	96 005
P	5 553/13	Vaso	193,197,545	Int. Alluminio	96 601
P	5 553/20	Vaso	192	Int. Alluminio	96 055
T	5 564/20	Vaso	192	Int. Alluminio	96 055
T	5 564/28	Vaso	193	Int. Alluminio	96 532
P	5 575/16	Vasca	192	Int. Rame	96 026
T	5 576/56	Vaso	75	Int. Alluminio	96 224
T	5 586/16	Vasca	192	Int. Rame	96 026
P	5 611/17	Vasca	57	Int. Rame	96 064
P	5 655/20	Vaso	57	Int. Rame	96 031
P	5 790/16	Vasca	133	Int. Rame	96 005
P	5 830/13	Vaso	133,137,542	Int. Alluminio	96 052
P	5 830/20	Vaso	132	Int. Alluminio	96 003
T	5 831/20	Vaso	132	Int. Alluminio	96 003
T	5 831/28	Vaso	132	Int. Rame	96 496
P	5 832/16	Vasca	132	Int. Rame	96 005
T	5 833/16	Vasca	132	Int. Rame	96 005
T	5 848/17	Vasca	103	Int. Rame	96 005
P	5 859/17	Vasca	103	Int. Rame	96 005
T	5 861/27	Vaso	65	Int. Rame	96 485
P	5 872/20P	Vaso	103	Int. Plastica	97 442
T	5 883/20P	Vaso	103	Int. Plastica	97 442
T	5 883/30P	Vaso	103	Int. Plastica	97 464
P	5 901/19	Vaso	155	Int. Alluminio	96 758
T	5 912/19	Vaso	155	Int. Alluminio	96 758
P	5 972/19R	Vaso	174	Int. Alluminio	96 758
P	5 974/19P	Vaso	86	Int. Plastica	97 112
P	5 974/19R	Vaso	86	Int. Alluminio	96 059
P	5 976/19	Vaso	87	Int. Alluminio	96 059
P	5 977/19R	Vaso	129	Int. Alluminio	96 059
T	5 983/19R	Vaso	174	Int. Alluminio	96 758
T	5 985/19P	Vaso	86	Int. Plastica	97 112
T	5 985/19R	Vaso	86	Int. Alluminio	96 059
T	5 985/30P	Vaso	86	Int. Plastica	97 065
T	5 985/30R	Vaso	86	Int. Alluminio	96 057
T	5 987/19	Vaso	87	Int. Alluminio	96 059
T	5 987/30	Vaso	87	Int. Alluminio	96 057

6

T	6 428/30	Vaso	65	Int. Rame	96 257
P	6 439/17	Vasca	28	Int. Rame	96 064
P	6 441/17	Vasca	29	Int. Rame	96 064
P	6 452/22	Vaso	28	Int. Rame	96 031
P	6 485/20	Vaso	65	Int. Plastica	97 475
T	6 496/20	Vaso	65	Int. Plastica	97 475
P	6 601/20P	Vaso	96	Int. Plastica	97 442
P	6 601/20R	Vaso	96	Int. Alluminio	96 003
T	6 603/20P	Vaso	96	Int. Plastica	97 442
T	6 603/20R	Vaso	96	Int. Alluminio	96 003
P	6 605/20P	Vaso	179	Int. Plastica	97 444
T	6 606/20P	Vaso	179	Int. Plastica	97 444
P	6 609/20P	Vaso	157	Int. Plastica	97 444

OGGETTISTICA ORNAMENTALE

	Codice Articolo	Descrizione	Pagina	Accessorio	
				Descrizione	Codice
P	6 609/20R	Vaso	157	Int. Alluminio	96 055
T	6 611/20P	Vaso	157	Int. Plastica	97 444
T	6 611/20R	Vaso	157	Int. Alluminio	96 055
P	6 645/19	Vaso	64	Int. Rame	96 656
P	6 645/23	Vaso	64	Int. Rame	96 667
T	6 656/19	Vaso	64	Int. Rame	96 656
T	6 656/23	Vaso	64	Int. Rame	96 667
T	6 667/20	Vaso	105	Int. Plastica	97 486
P	6 705/17P	Vasca	96	Int. Plastica	97 021
P	6 705/17R	Vasca	96	Int. Rame	96 005
T	6 707/17P	Vasca	96	Int. Plastica	97 021
T	6 707/17R	Vasca	96	Int. Rame	96 005
P	6 709/17P	Vasca	179	Int. Plastica	97 024
T	6 710/17P	Vasca	179	Int. Plastica	97 024
P	6 715/17P	Vasca	157	Int. Plastica	97 024
P	6 715/17R	Vasca	157	Int. Rame	96 026
T	6 717/17P	Vasca	157	Int. Plastica	97 024
T	6 717/17R	Vasca	157	Int. Rame	96 026
P	6 887/17P	Vasca	91	Int. Plastica	97 021
P	6 887/17R	Vasca	91	Int. Rame	96 005
P	6 889/20P	Vaso	91	Int. Plastica	97 442
P	6 889/20R	Vaso	91	Int. Alluminio	96 003
T	6 892/20P	Vaso	91	Int. Plastica	97 442
T	6 892/20R	Vaso	91	Int. Alluminio	96 003
T	6 892/30P	Vaso	91	Int. Plastica	97 464
T	6 892/30R	Vaso	91	Int. Alluminio	96 058
T	6 894/17P	Vasca	91	Int. Plastica	97 021
T	6 894/17R	Vasca	91	Int. Rame	96 005
P	6 954/20	Vaso	50	Int. Rame	96 031
P	6 957/17	Vasca	50	Int. Rame	96 064
T	6 965/20	Vaso	50	Int. Rame	96 031
T	6 968/17	Vasca	50	Int. Rame	96 064
P	6 970/20	Vaso	147	Int. Alluminio	96 055
P	6 972/12	Vaso	49,537	Int. Rame	96 029
P	6 972/20	Vaso	48	Int. Rame	96 031
P	6 975/17	Vasca	48	Int. Rame	96 064
P	6 978/17	Vasca	49	Int. Rame	96 064
P	6 980/17	Vasca	147	Int. Rame	96 452
T	6 983/20	Vaso	48	Int. Rame	96 031
T	6 983/30	Vaso	49	Int. Rame	96 257
T	6 986/17	Vasca	48	Int. Rame	96 064
T	6 991/20	Vaso	147	Int. Alluminio	96 055
T	6 993/17	Vasca	147	Int. Rame	96 452

7

P	7 003/20	Lampada Elett.	181	Fiamma Vetro	98 015
P	7 004/16	Lampada Elett.	69,536	Fiamma Vetro	98 043
P	7 004/19	Lampada Elett.	69	Fiamma Vetro	98 015
P	7 007/20	Lampada Elett.	104	Fiamma Vetro	98 015
P	7 012/13	Lampada Elett.	537	Fiamma Vetro	98 048
T	7 018/19	Lampada Elett.	69	Fiamma Vetro	98 015
P	7 019/11	Lampada Elett.	540	Fiamma Polic.	97 511
P	7 021/15	Lampada Elett.	27,537	Fiamma Vetro	98 044
P	7 021/20	Lampada Elett.	26	Fiamma Vetro	98 055
P	7 023/20	Lampada Elett.	106	Fiamma Vetro	98 015
P	7 026/20	Lampada Elett.	135	Fiamma Vetro	98 015
P	7 032/9	Lampada Elett.	102,538	Fiamma Polic.	97 511
P	7 034/19	Lampada Elett.	24	Fiamma Vetro	98 015
T	7 035/27	Lampada Elett.	27	Fiamma Vetro	98 066
P	7 038/20	Lampada Elett.	41	Fiamma Vetro	98 015
T	7 043/9	Lampada Elett.	102,538	Fiamma Polic.	97 511
P	7 050/15	Lampada Elett.	83,538	Fiamma Vetro	98 035
P	7 050/20	Lampada Elett.	83	Fiamma Vetro	98 015
P	7 054/12	Lampada Elett.	101,539	Fiamma Polic.	97 511
P	7 060/18	Lampada Elett.	33	Fiamma Vetro	98 055
T	7 062/20	Lampada Elett.	83	Fiamma Vetro	98 015
T	7 063/19	Lampada Elett.	24	Fiamma Vetro	98 015

OGGETTISTICA ORNAMENTALE

	Codice Articolo	Descrizione	Pagina	Accessorio	
				Descrizione	Codice
P	7 064/15	Lampada Elett.	168,545	Fiamma Vetro	98 035
P	7 064/20	Lampada Elett.	168	Fiamma Vetro	98 015
T	7 065/12	Lampada Elett.	101,539	Fiamma Polic.	97 511
P	7 067/11	Lampada Elett.	249		
P	7 068/16	Lampada Elett.	70,536	Fiamma Vetro	98 043
P	7 068/19	Lampada Elett.	70	Fiamma Vetro	98 015
P	7 070/15	Lampada Elett.	84,538	Fiamma Vetro	98 035
P	7 070/20	Lampada Elett.	84	Fiamma Vetro	98 015
P	7 072/15	Lampada Elett.	540	Fiamma Vetro	98 044
P	7 073/19	Lampada Elett.	25	Fiamma Vetro	98 015
P	7 075/15	Lampada Elett.	191,197,545	Fiamma Vetro	98 035
P	7 075/20	Lampada Elett.	191	Fiamma Vetro	98 015
T	7 078/20	Lampada Elett.	41	Fiamma Vetro	98 015
P	7 080/15	Lampada Elett.	126,137,542	Fiamma Vetro	98 035
P	7 080/20	Lampada Elett.	126	Fiamma Vetro	98 015
T	7 080/20	Lampada Elett.	84	Fiamma Vetro	98 015
T	7 088/20	Lampada Elett.	191	Fiamma Vetro	98 015
P	7 091/18	Lampada Elett.	108	Fiamma Vetro	98 055
T	7 093/20	Lampada Elett.	168	Fiamma Vetro	98 015
T	7 095/20	Lampada Elett.	126	Fiamma Vetro	98 015
T	7 095/19	Lampada Elett.	25	Fiamma Vetro	98 015
T	7 100/13	Lampada Elett.	81,540	Fiamma Vetro	98 044
T	7 100/20	Lampada Elett.	80	Fiamma Vetro	98 055
T	7 100/25	Lampada Elett.	81	Fiamma Vetro	98 066
P	7 101/23	Lampada Elett.	33	Fiamma Vetro	98 055
P	7 103/34	Lampada Elett.	33	Fiamma Vetro	98 055
P	7 110/20	Lampada Elett.	32	Fiamma Vetro	98 015
T	7 111/20	Lampada Elett.	32	Fiamma Vetro	98 015
P	7 115/13	Lampada Elett.	539	Fiamma Vetro	98 044
T	7 116/19	Lampada Elett.	70	Fiamma Vetro	98 015
P	7 117/14	Lampada Elett.	114	Fiamma Vetro	98 044
P	7 117/19	Lampada Elett.	114	Fiamma Vetro	98 055
P	7 118/14	Lampada Elett.	173,186,544	Fiamma Vetro	98 044
P	7 118/19	Lampada Elett.	173	Fiamma Vetro	98 055
P	7 125/15	Lampada Elett.	150,159,543	Fiamma Vetro	98 035
P	7 125/20	Lampada Elett.	150	Fiamma Vetro	98 015
P	7 127/14	Lampada Elett.	113	Fiamma Vetro	98 044
P	7 127/19	Lampada Elett.	113	Fiamma Vetro	98 055
P	7 129/16	Lampada Elett.	172,186,536	Fiamma Vetro	98 043
P	7 129/19	Lampada Elett.	172	Fiamma Vetro	98 015
P	7 130/13	Lampada Elett.	539	Fiamma Vetro	98 044
P	7 132/14	Lampada Elett.	116	Fiamma Vetro	98 044
P	7 132/19	Lampada Elett.	116	Fiamma Vetro	98 055
P	7 136/14	Lampada Elett.	73,538	Fiamma Vetro	98 044
P	7 136/19	Lampada Elett.	73	Fiamma Vetro	98 055
P	7 137/14	Lampada Elett.	149,159,543	Fiamma Vetro	98 044
P	7 137/19	Lampada Elett.	149	Fiamma Vetro	98 055
P	7 138/15	Lampada Elett.	42,537	Fiamma Vetro	98 035
P	7 138/20	Lampada Elett.	42	Fiamma Vetro	98 015
P	7 140/20	Lampada Elett.	46	Fiamma Vetro	98 055
T	7 141/19	Lampada Elett.	172	Fiamma Vetro	98 015
P	7 142/14	Lampada Elett.	115	Fiamma Vetro	98 044
P	7 142/19	Lampada Elett.	115	Fiamma Vetro	98 055
P	7 144/14	Lampada Elett.	112	Fiamma Vetro	98 044
P	7 144/19	Lampada Elett.	112	Fiamma Vetro	98 055
T	7 145/20	Lampada Elett.	150	Fiamma Vetro	98 015
P	7 147/20	Lampada Elett.	44	Fiamma Vetro	98 015
T	7 148/19	Lampada Elett.	73	Fiamma Vetro	98 055
P	7 149/14	Lampada Elett.	125,137,542	Fiamma Vetro	98 044
P	7 149/19	Lampada Elett.	125	Fiamma Vetro	98 055
P	7 150/20	Lampada Elett.	47	Fiamma Vetro	98 055
P	7 153/14	Lampada Elett.	118	Fiamma Vetro	98 044
P	7 153/19	Lampada Elett.	118	Fiamma Vetro	98 055
P	7 154/16	Lampada Elett.	71,536	Fiamma Vetro	98 043
P	7 154/19	Lampada Elett.	71	Fiamma Vetro	98 015
P	7 155/20	Lampada Elett.	45	Fiamma Vetro	98 015
P	7 159/14	Lampada Elett.	117	Fiamma Vetro	98 044
P	7 159/19	Lampada Elett.	117	Fiamma Vetro	98 055

OGGETTISTICA ORNAMENTALE

	Codice Articolo	Descrizione	Pagina	Accessorio	
				Descrizione	Codice
P	7 162/14	Lampada Elett.	111	Fiamma Vetro	98 044
P	7 162/19	Lampada Elett.	111	Fiamma Vetro	98 055
P	7 170/14	Lampada Elett.	119	Fiamma Vetro	98 044
P	7 170/19	Lampada Elett.	119	Fiamma Vetro	98 055
T	7 180/20	Lampada Elett.	46	Fiamma Vetro	98 055
T	7 180/26	Lampada Elett.	46	Fiamma Vetro	98 066
T	7 182/20	Lampada Elett.	42	Fiamma Vetro	98 015
P	7 190/13	Lampada Elett.	81,540	Fiamma Vetro	98 044
P	7 190/20	Lampada Elett.	80	Fiamma Vetro	98 055
T	7 195/20	Lampada Elett.	44	Fiamma Vetro	98 015
P	7 204/20	Lampada Elett.	43	Fiamma Vetro	98 015
P	7 205/20	Lampada Elett.	82	Fiamma Vetro	98 055
P	7 214/18	Lampada Elett.	63	Fiamma Vetro	98 055
T	7 230/20	Lampada Elett.	47	Fiamma Vetro	98 055
T	7 230/26	Lampada Elett.	47	Fiamma Vetro	98 066
T	7 238/20	Lampada Elett.	43	Fiamma Vetro	98 015
P	7 240/15	Lampada Elett.	89,538	Fiamma Vetro	98 035
P	7 240/21	Lampada Elett.	88	Fiamma Vetro	98 055
T	7 242/15	Lampada Elett.	89,538	Fiamma Vetro	98 035
T	7 242/21	Lampada Elett.	88	Fiamma Vetro	98 055
T	7 242/27	Lampada Elett.	89	Fiamma Vetro	98 066
P	7 244/15	Lampada Elett.	175,186,544	Fiamma Vetro	98 035
P	7 244/21	Lampada Elett.	175	Fiamma Vetro	98 055
T	7 246/21	Lampada Elett.	175	Fiamma Vetro	98 055
P	7 253/15	Lampada Elett.	154,159,543	Fiamma Vetro	98 035
P	7 253/21	Lampada Elett.	154	Fiamma Vetro	98 055
T	7 255/15	Lampada Elett.	154,159,543	Fiamma Vetro	98 035
T	7 255/21	Lampada Elett.	154	Fiamma Vetro	98 055
P	7 270/15	Lampada Elett.	137,542	Fiamma Vetro	98 035
P	7 293/19	Lampada Elett.	65	Fiamma Vetro	98 015
T	7 300/20	Lampada Elett.	82	Fiamma Vetro	98 055
T	7 300/25	Lampada Elett.	82	Fiamma Vetro	98 066
P	7 301/15	Lampada Elett.	39,537	Fiamma Vetro	98 035
P	7 301/20	Lampada Elett.	38	Fiamma Vetro	98 015
P	7 303/20	Lampada Elett.	40	Fiamma Vetro	98 015
T	7 312/20	Lampada Elett.	38	Fiamma Vetro	98 015
T	7 312/25	Lampada Elett.	39	Fiamma Vetro	98 060
T	7 314/20	Lampada Elett.	40	Fiamma Vetro	98 015
T	7 314/25	Lampada Elett.	40	Fiamma Vetro	98 060
P	7 375/56	Lampada Elett.	518	Fiamma Vetro	98 088
P	7 380/46	Lampada Elett.	518	Fiamma Vetro	98 066
P	7 431/18	Lampada Elett.	104	Fiamma Vetro	98 015
P	7 497/19	Lampada Elett.	108	Fiamma Vetro	98 055
P	7 511/19	Lampada Elett.	108	Fiamma Vetro	98 055
P	7 555/16	Lampada Elett.	108	Fiamma Vetro	98 044
T	7 566/15	Lampada Elett.	108	Fiamma Vetro	98 044
P	7 577/20	Lampada Elett.	108	Fiamma Vetro	98 055
T	7 588/20	Lampada Elett.	108	Fiamma Vetro	98 055
P	7 599/19	Lampada Elett.	108	Fiamma Vetro	98 055
T	7 602/21	Lampada Elett.	108	Fiamma Vetro	98 055
P	7 702/20	Lampada Elett.	151	Fiamma Vetro	98 055
T	7 703/20	Lampada Elett.	151	Fiamma Vetro	98 055
P	7 709/13	Lampada Elett.	152,159,543	Fiamma Vetro	98 044
P	7 709/20	Lampada Elett.	152	Fiamma Vetro	98 055
T	7 710/20	Lampada Elett.	152	Fiamma Vetro	98 055
P	7 759/19	Lampada Elett.	65	Fiamma Vetro	98 015
P	7 834/19	Lampada Elett.	130	Fiamma Vetro	98 015
P	7 839/19	Lampada Elett.	53	Fiamma Vetro	98 015
P	7 850/17	Lampada Elett.	130	Fiamma Vetro	98 015
P	7 852/17	Lampada Elett.	52	Fiamma Vetro	98 015
T	7 863/17	Lampada Elett.	52	Fiamma Vetro	98 015
T	7 869/17	Lampada Elett.	130	Fiamma Vetro	98 015
P	7 896/18	Lampada Elett.	62	Fiamma Vetro	98 015
P	7 960/13	Lampada Elett.	538	Fiamma Vetro	98 044

OGGETTISTICA ORNAMENTALE

	Codice Articolo	Descrizione	Pagina	Accessorio	
				Descrizione	Codice
T	8 088/17	Lampada Elett.	105	Fiamma Vetro	98 015
P	8 099/17	Lampada Elett.	105	Fiamma Vetro	98 015
T	8 102/17	Lampada Elett.	105	Fiamma Vetro	98 015
T	8 380/21	Lampada Elett.	85	Fiamma Vetro	98 055
P	8 385/21	Lampada Elett.	156	Fiamma Vetro	98 055
P	8 390/21	Lampada Elett.	128	Fiamma Vetro	98 055
P	8 933/13	Lampada Elett.	102	Fiamma Vetro	98 022
T	8 944/13	Lampada Elett.	102	Fiamma Vetro	98 022

9

P	9 002/16	Lampada Elett.	58	Fiamma Vetro	98 015
T	9 011/16	Lampada Elett.	58	Fiamma Vetro	98 015
P	9 013/20	Lampada Elett.	31	Fiamma Vetro	98 055
P	9 015/20	Lampada Elett.	30	Fiamma Vetro	98 055
T	9 017/20	Lampada Elett.	30	Fiamma Vetro	98 055
P	9 020/21	Lampada Elett.	194	Fiamma Vetro	98 055
P	9 022/21	Lampada Elett.	134	Fiamma Vetro	98 055
P	9 025/21	Lampada Elett.	177	Fiamma Vetro	98 055
P	9 026/21	Lampada Elett.	76	Fiamma Vetro	98 055
P	9 028/21	Lampada Elett.	78	Fiamma Vetro	98 055
P	9 031/21	Lampada Elett.	99	Fiamma Vetro	98 055
P	9 033/21	Lampada Elett.	148	Fiamma Vetro	98 055
P	9 034/18	Lampada Elett.	101	Fiamma Vetro	98 055
T	9 037/21	Lampada Elett.	76	Fiamma Vetro	98 055
T	9 037/27	Lampada Elett.	77	Fiamma Vetro	98 066
T	9 039/21	Lampada Elett.	194	Fiamma Vetro	98 055
T	9 040/21	Lampada Elett.	99	Fiamma Vetro	98 055
T	9 040/30	Lampada Elett.	99	Fiamma Vetro	98 066
T	9 042/21	Lampada Elett.	78	Fiamma Vetro	98 055
T	9 042/27	Lampada Elett.	79	Fiamma Vetro	98 066
T	9 045/18	Lampada Elett.	101	Fiamma Vetro	98 055
T	9 045/25	Lampada Elett.	101	Fiamma Vetro	98 066
T	9 047/21	Lampada Elett.	177	Fiamma Vetro	98 055
P	9 056/18	Lampada Elett.	59	Fiamma Vetro	98 015
P	9 060/20	Lampada Elett.	107	Fiamma Vetro	98 015
P	9 065/20	Lampada Elett.	136	Fiamma Vetro	98 015
T	9 067/18	Lampada Elett.	59	Fiamma Vetro	98 015
T	9 067/24	Lampada Elett.	59	Fiamma Vetro	98 060
P	9 070/20	Lampada Elett.	169	Fiamma Vetro	98 015
T	9 072/18	Lampada Elett.	131	Fiamma Vetro	98 015
P	9 074/20	Lampada Elett.	182	Fiamma Vetro	98 015
P	9 075/20	Lampada Elett.	182	Fiamma Vetro	98 015
P	9 076/20	Lampada Elett.	158	Fiamma Vetro	98 015
P	9 078/18	Lampada Elett.	61	Fiamma Vetro	98 015
P	9 082/20	Lampada Elett.	107	Fiamma Vetro	98 015
T	9 087/21	Lampada Elett.	134	Fiamma Vetro	98 055
T	9 088/20	Lampada Elett.	196	Fiamma Vetro	98 015
T	9 089/18	Lampada Elett.	61	Fiamma Vetro	98 015
T	9 089/24	Lampada Elett.	61	Fiamma Vetro	98 060
P	9 091/18	Lampada Elett.	60	Fiamma Vetro	98 015
P	9 095/20	Lampada Elett.	196	Fiamma Vetro	98 015
P	9 102/18	Lampada Elett.	131	Fiamma Vetro	98 015
T	9 103/18	Lampada Elett.	60	Fiamma Vetro	98 015
T	9 103/24	Lampada Elett.	60	Fiamma Vetro	98 060
P	9 105/19	Lampada Elett.	155	Fiamma Vetro	98 055
P	9 106/19	Lampada Elett.	124	Fiamma Vetro	98 015
P	9 107/20	Lampada Elett.	136	Fiamma Vetro	98 015
T	9 112/19	Lampada Elett.	124	Fiamma Vetro	98 015
P	9 114/13	Lampada Elett.	100,539	Fiamma Vetro	98 044
P	9 114/18	Lampada Elett.	100	Fiamma Vetro	98 015
T	9 116/19	Lampada Elett.	155	Fiamma Vetro	98 055
P	9 117/19	Lampada Elett.	127	Fiamma Vetro	98 015
T	9 118/19	Lampada Elett.	127	Fiamma Vetro	98 015
T	9 121/21	Lampada Elett.	180	Fiamma Vetro	98 055
P	9 122/21	Lampada Elett.	94	Fiamma Vetro	98 055
P	9 123/21	Lampada Elett.	92	Fiamma Vetro	98 055
T	9 125/13	Lampada Elett.	100,539	Fiamma Vetro	98 044

OGGETTISTICA ORNAMENTALE

	Codice Articolo	Descrizione	Pagina	Accessorio	
				Descrizione	Codice
T	9 125/18	Lampada Elett.	100	Fiamma Vetro	98 015
T	9 125/24	Lampada Elett.	100	Fiamma Vetro	98 060
P	9 127/21	Lampada Elett.	195	Fiamma Vetro	98 055
P	9 128/13	Lampada Elett.	159,543	Fiamma Vetro	98 044
P	9 130/20	Lampada Elett.	97	Fiamma Vetro	98 055
T	9 132/20	Lampada Elett.	97	Fiamma Vetro	98 055
T	9 132/26	Lampada Elett.	97	Fiamma Vetro	98 066
T	9 143/21	Lampada Elett.	180	Fiamma Vetro	98 055
T	9 144/21	Lampada Elett.	94	Fiamma Vetro	98 055
T	9 144/27	Lampada Elett.	95	Fiamma Vetro	98 066
T	9 145/21	Lampada Elett.	92	Fiamma Vetro	98 055
T	9 145/27	Lampada Elett.	93	Fiamma Vetro	98 066
T	9 147/24	Lampada Elett.	53	Fiamma Vetro	98 066
T	9 153/21	Lampada Elett.	195	Fiamma Vetro	98 055
P	9 158/16	Lampada Elett.	58	Fiamma Vetro	98 015
P	9 158/18	Lampada Elett.	58	Fiamma Vetro	98 015
T	9 169/18	Lampada Elett.	58	Fiamma Vetro	98 015
T	9 169/21	Lampada Elett.	58	Fiamma Vetro	98 060
P	9 190/19	Lampada Elett.	129	Fiamma Vetro	98 055
P	9 193/19	Lampada Elett.	86	Fiamma Vetro	98 055
P	9 195/19	Lampada Elett.	174	Fiamma Vetro	98 055
P	9 196/19	Lampada Elett.	87	Fiamma Vetro	98 055
T	9 203/19	Lampada Elett.	174	Fiamma Vetro	98 055
T	9 205/19	Lampada Elett.	86	Fiamma Vetro	98 055
T	9 205/25	Lampada Elett.	86	Fiamma Vetro	98 066
T	9 207/19	Lampada Elett.	87	Fiamma Vetro	98 055
T	9 207/25	Lampada Elett.	87	Fiamma Vetro	98 066
P	9 216/17	Lampada Elett.	56	Fiamma Vetro	98 102
P	9 218/17	Lampada Elett.	178	Fiamma Vetro	98 102
T	9 227/17	Lampada Elett.	56	Fiamma Vetro	98 102
T	9 229/17	Lampada Elett.	178	Fiamma Vetro	98 102
P	9 231/21	Lampada Elett.	106	Fiamma Vetro	98 055
P	9 233/21	Lampada Elett.	136	Fiamma Vetro	98 055
P	9 235/21	Lampada Elett.	158	Fiamma Vetro	98 055
P	9 237/21	Lampada Elett.	182	Fiamma Vetro	98 055
P	9 251/19	Lampada Elett.	56	Fiamma Vetro	98 102
P	9 253/19	Lampada Elett.	178	Fiamma Vetro	98 102
T	9 262/20	Lampada Elett.	56	Fiamma Vetro	98 102
T	9 264/19	Lampada Elett.	178	Fiamma Vetro	98 102
P	9 266/14	Lampada Elett.	98,539	Fiamma Vetro	98 044
P	9 266/21	Lampada Elett.	98	Fiamma Vetro	98 055
P	9 295/17	Lampada Elett.	56	Fiamma Vetro	98 102
P	9 297/17	Lampada Elett.	178	Fiamma Vetro	98 102
P	9 353/20	Lampada Elett.	64	Fiamma Vetro	98 055
P	9 353/24	Lampada Elett.	64	Fiamma Vetro	98 066
T	9 364/20	Lampada Elett.	64	Fiamma Vetro	98 055
T	9 364/24	Lampada Elett.	64	Fiamma Vetro	98 066
T	9 370/14	Lampada Elett.	98,539	Fiamma Vetro	98 044
T	9 370/21	Lampada Elett.	98	Fiamma Vetro	98 055
T	9 370/27	Lampada Elett.	98	Fiamma Vetro	98 066
P	9 401/19	Lampada Elett.	15	Fiamma Crist.Ø 5	98 041
P	9 424/19	Lampada Elett.	17	Fiamma Crist.Ø 5	98 041
P	9 435/19	Lampada Elett.	19	Fiamma Crist.Ø 5	98 041
P	9 468/19	Lampada Elett.	21	Fiamma Crist.Ø 5	98 041
P	9 515/20	Lampada Elett.	54	Fiamma Vetro	98 015
P	9 517/20	Lampada Elett.	146	Fiamma Vetro	98 015
P	9 519/20	Lampada Elett.	167	Fiamma Vetro	98 015
T	9 526/20	Lampada Elett.	54	Fiamma Vetro	98 015
T	9 526/27	Lampada Elett.	54	Fiamma Vetro	98 060
T	9 528/20	Lampada Elett.	146	Fiamma Vetro	98 015
P	9 531/16	Lampada Elett.	123,137,536	Fiamma Vetro	98 043
P	9 531/19	Lampada Elett.	123	Fiamma Vetro	98 015
P	9 533/15	Lampada Elett.	176,186,544	Fiamma Vetro	98 035
P	9 533/18	Lampada Elett.	176	Fiamma Vetro	98 015
P	9 535/15	Lampada Elett.	75,539	Fiamma Vetro	98 035
P	9 535/18	Lampada Elett.	74	Fiamma Vetro	98 015
P	9 535/26	Lampada Elett.	74	Fiamma Vetro	98 060
T	9 542/18	Lampada Elett.	176	Fiamma Vetro	98 015

OGGETTISTICA ORNAMENTALE

	Codice Articolo	Descrizione	Pagina	Accessorio	
				Descrizione	Codice
T	9 546/15	Lampada Elett.	75,539	Fiamma Vetro	98 035
T	9 546/18	Lampada Elett.	74	Fiamma Vetro	98 015
T	9 546/26	Lampada Elett.	74	Fiamma Vetro	98 060
P	9 557/19	Lampada Elett.	55	Fiamma Vetro	98 015
T	9 568/19	Lampada Elett.	55	Fiamma Vetro	98 015
T	9 568/26	Lampada Elett.	55	Fiamma Vetro	98 060
P	9 579/19	Lampada Elett.	55	Fiamma Vetro	98 015
P	9 592/22	Lampada Elett.	29	Fiamma Vetro	98 055
P	9 603/21	Lampada Elett.	90	Fiamma Vetro	98 055
P	9 605/21	Lampada Elett.	153	Fiamma Vetro	98 055
T	9 606/21	Lampada Elett.	153	Fiamma Vetro	98 055
P	9 607/15	Lampada Elett.	133,137,542	Fiamma Vetro	98 035
P	9 607/18	Lampada Elett.	132	Fiamma Vetro	98 015
T	9 608/18	Lampada Elett.	132	Fiamma Vetro	98 015
T	9 608/26	Lampada Elett.	132	Fiamma Vetro	98 060
P	9 659/15	Lampada Elett.	193,197,545	Fiamma Vetro	98 035
P	9 659/18	Lampada Elett.	192	Fiamma Vetro	98 015
T	9 661/18	Lampada Elett.	192	Fiamma Vetro	98 015
T	9 661/26	Lampada Elett.	193	Fiamma Vetro	98 060
P	9 672/19	Lampada Elett.	57	Fiamma Vetro	98 015
T	9 692/21	Lampada Elett.	90	Fiamma Vetro	98 055
T	9 692/27	Lampada Elett.	90	Fiamma Vetro	98 066
P	9 774/19	Lampada Elett.	103	Fiamma Vetro	98 055
T	9 785/19	Lampada Elett.	103	Fiamma Vetro	98 055
T	9 785/26	Lampada Elett.	103	Fiamma Vetro	98 066
T	9 801/02	Ghiera	334		
T	9 802/17	Ghiera	334	Fiamma Vetro	98 066
T	9 803/13	Ghiera	140,335	Fiamma Vetro	98 055
T	9 804/02	Ghiera	335		
T	9 806/17	Ghiera	202	Fiamma Vetro	98 066
T	9 807/0	Ghiera	140,335		
T	9 808/26	Lampada Elett.	65	Fiamma Vetro	98 066
T	9 810/13	Ghiera	334	Fiamma Vetro	98 055
T	9 812/17	Ghiera	198,334	Fiamma Vetro	98 066
T	9 813/17	Ghiera	334	Fiamma Vetro	98 066
T	9 815/17	Ghiera	187,334	Fiamma Vetro	98 066
P	9 819/22	Lampada Elett.	28	Fiamma Vetro	98 055
T	9 820/03	Ghiera	334		
T	9 823/03	Ghiera	334		
T	9 825/02	Ghiera	202		
T	9 827/03	Ghiera	202		
T	9 830/03	Ghiera	334		
P	9 834/19	Lampada Elett.	96	Fiamma Vetro	98 015
T	9 836/03	Ghiera	198,334		
T	9 839/13	Ghiera	187,334	Fiamma Vetro	98 055
T	9 841/19	Lampada Elett.	96	Fiamma Vetro	98 015
P	9 843/20	Lampada Elett.	105	Fiamma Vetro	98 055
P	9 845/19	Lampada Elett.	179	Fiamma Vetro	98 015
T	9 846/19	Lampada Elett.	179	Fiamma Vetro	98 015
P	9 849/19	Lampada Elett.	157	Fiamma Vetro	98 015
T	9 851/19	Lampada Elett.	157	Fiamma Vetro	98 015
T	9 852/13	Ghiera	335	Fiamma Vetro	98 055
T	9 858/13	Ghiera	202	Fiamma Vetro	98 055
T	9 862/10	Ghiera	334	Fiamma Vetro	98 044
P	9 865/20	Lampada Elett.	65	Fiamma Vetro	98 055
T	9 868/10	Ghiera	202	Fiamma Vetro	98 044
T	9 873/10	Ghiera	198,334	Fiamma Vetro	98 044
T	9 875/10	Ghiera	187,334	Fiamma Vetro	98 044
T	9 876/20	Lampada Elett.	65	Fiamma Vetro	98 055
T	9 880/13	Ghiera	140,335	Fiamma Vetro	98 055
T	9 885/03	Ghiera	140,335		
P	9 887/21	Lampada Elett.	65	Fiamma Vetro	98 055
T	9 890/10	Ghiera	140,335	Fiamma Vetro	98 044
T	9 895/02	Ghiera	140,335		
T	9 896/04	Ghiera	140,335		
T	9 901/17	Ghiera	140,335	Fiamma Vetro	98 066
T	9 902/03	Ghiera	165,335		
T	9 903/03	Ghiera	334		

OGGETTISTICA ORNAMENTALE

	Codice Articolo	Descrizione	Pagina	Accessorio	
				Descrizione	Codice
T	9 905/03	Ghiera	202		
T	9 906/03	Ghiera	198,334		
T	9 907/03	Ghiera	187,334		
T	9 908/03	Ghiera	165,335	Fiamma Vetro	98 066
T	9 910/0	Ghiera	335		
T	9 911/0	Ghiera	335		
T	9 912/13	Ghiera	334	Fiamma Vetro	98 055
T	9 914/13	Ghiera	202	Fiamma Vetro	98 055
T	9 915/0	Ghiera	202		
T	9 916/13	Ghiera	198,334	Fiamma Vetro	98 055
T	9 917/0	Ghiera	202		
T	9 918/02	Ghiera	198,334		
T	9 927/02	Ghiera	334		
T	9 929/02	Ghiera	202		
T	9 931/03	Ghiera	165,335	Fiamma Vetro	98 055
T	9 932/03	Ghiera	187,334		
T	9 933/02	Ghiera	187,334		
T	9 934/12	Ghiera	335	Fiamma Vetro	98 055
T	9 936/12	Ghiera	202	Fiamma Vetro	98 055
T	9 940/02	Ghiera	165,335		
T	9 946/03	Ghiera	165,335		
T	9 949/0	Ghiera	165,335		
T	9 950/0	Ghiera	165,335	Fiamma Vetro	98 055
T	9 954/02	Ghiera	165,335	Fiamma Vetro	98 044
T	9 960/10	Ghiera	334	Fiamma Vetro	98 044
P	9 962/0	Ghiera	333		
P	9 982/19	Lampada Elett.	91	Fiamma Vetro	98 015
T	9 984/19	Lampada Elett.	147	Fiamma Vetro	98 015
P	9 986/13	Lampada Elett.	49,537	Fiamma Vetro	98 035
P	9 986/19	Lampada Elett.	48	Fiamma Vetro	98 015
P	9 988/19	Lampada Elett.	50	Fiamma Vetro	98 015
P	9 992/19	Lampada Elett.	147	Fiamma Vetro	98 015
T	9 994/19	Lampada Elett.	91	Fiamma Vetro	98 015
T	9 994/26	Lampada Elett.	91	Fiamma Vetro	98 060
T	9 996/19	Lampada Elett.	50	Fiamma Vetro	98 015
T	9 998/19	Lampada Elett.	48	Fiamma Vetro	98 015
T	9 998/25	Lampada Elett.	49	Fiamma Vetro	98 060

10

P	10 001/21	Lampada Cero	381	Cristallo	98 031
T	10 003/25	Lampada Cero	377		
T	10 005/25	Lampada Cero	24,377	Cristallo	98 002
P	10 007/20	Lampada Cero	39,376	Bicchieri	97 600
T	10 012/22	Lampada Cero	381	Cristallo	98 031
P	10 014/9	Lampada Cero	381,540	Bicchieri	97 613
T	10 016/20	Lampada Cero	39,376	Bicchieri	97 600
T	10 021/25	Lampada Cero	25,377	Cristallo	98 002
P	10 023/20	Lampada Cero	40,376	Bicchieri	97 600
T	10 029/23	Lampada Cero	73,377	Cristallo	98 429
P	10 030/20	Lampada Cero	82,378	Cristallo	98 165
T	10 031/20	Lampada Cero	40,376	Bicchieri	97 600
T	10 040/20	Lampada Cero	82,378	Cristallo	98 165
T	10 040/25	Lampada Cero	82,378	Cristallo	98 385
P	10 050/20	Lampada Cero	42,376	Bicchieri	97 600
T	10 051/25	Lampada Cero	377		
P	10 060/32	Lampada Cero	382	Vetro	98 183
P	10 060/37	Lampada Cero	382	Vetro	98 185
P	10 062/18	Lampada Cero	382	Vetro	98 177
P	10 062/18	Lampada Cero	382	Vetro	98 187
P	10 064/32	Lampada Cero	382	Vetro	98 189
P	10 064/32	Lampada Cero	382	Vetro	98 183
P	10 064/37	Lampada Cero	382	Vetro	98 185
P	10 064/37	Lampada Cero	382	Vetro	98 175
T	10 065/20	Lampada Cero	42,376	Bicchieri	97 600
P	10 066/18	Lampada Cero	382	Vetro	98 187

OGGETTISTICA ORNAMENTALE
OGGETTISTICA ORNAMENTALE

Codice Articolo	Descrizione	Pagina	Accessorio	
			Descrizione	Codice
P 10 067/33	Lampada Cero	383	Vetro	98 189
P 10 070/12	Lampada Cero	381,540	Vetro	98 170
P 10 080/10	Lampada Cero	381,540	Vetro	98 180
T 10 082/22	Lampada Cero	65,377	Bicchieri	98 110
P 10 084/20	Lampada Cero	43,376	Bicchieri	97 613
P 10 085/12	Lampada Cero	81,381,540	Cristallo	98 200
P 10 085/20	Lampada Cero	81,378	Bicchieri	97 600
T 10 090/12	Lampada Cero	81,381,540	Bicchieri	98 110
T 10 090/20	Lampada Cero	81,378	Cristallo	98 165
T 10 090/23	Lampada Cero	81,378	Cristallo	98 385
P 10 100/12	Lampada Cero	381,540	Bicchieri	98 110
T 10 101/20	Lampada Cero	43,376	Bicchieri	97 600
T 10 110/22	Lampada Cero	377	Cristallo	98 260
T 10 111/23	Lampada Cero	377	Cristallo	98 429
P 10 116/20	Lampada Cero	109,381	Bicchieri	97 646
P 10 121/20	Lampada Cero	44,376	Bicchieri	97 600
T 10 127/22	Lampada Cero	109,381	Bicchieri	97 646
T 10 131/23	Lampada Cero	377	Cristallo	98 200
T 10 135/20	Lampada Cero	44,376	Bicchieri	97 600
P 10 138/14	Lampada Cero	109,381	Bicchieri	97 657
T 10 149/17	Lampada Cero	109,381	Bicchieri	97 657
P 10 151/18	Lampada Cero	109,381	Bicchieri	97 668
P 10 160/19	Lampada Cero	46,376	Bicchieri	97 600
T 10 162/23	Lampada Cero	109,381	Bicchieri	97 668
T 10 180/19	Lampada Cero	46,376	Bicchieri	97 600
P 10 186/15	Lampada Cero	28,318	Cristallo Circ.	98 871
P 10 200/19	Lampada Cero	47,376	Bicchieri	97 600
T 10 220/19	Lampada Cero	47,376	Bicchieri	97 600
P 10 231/21	Lampada Cero	53,379	Bicchieri	97 635
T 10 242/21	Lampada Cero	53,379	Bicchieri	97 635
P 10 303/18	Lampada Cero	49,378	Vetro	98 324
P 10 305/18	Lampada Cero	51,87,378	Vetro	98 324
P 10 307/18	Lampada Cero	86,96,378	Vetro	98 324
T 10 316/18	Lampada Cero	49,378	Vetro	98 324
T 10 316/24	Lampada Cero	49,378	Vetro	98 331
T 10 318/18	Lampada Cero	51,87,378	Vetro	98 324
P 10 318/24	Lampada Cero	87,378	Vetro	98 331
T 10 320/18	Lampada Cero	86,96,378	Vetro	98 324
T 10 320/24	Lampada Cero	58,378	Vetro	98 331
P 10 324/18	Lampada Cero	147	Vetro	98 324
T 10 331/18	Lampada Cero	147	Vetro	98 324
P 10 341/18	Lampada Cero	91,378	Vetro	98 324
P 10 344/19	Lampada Cero	28,376	Cristallo	98 328
P 10 346/19	Lampada Cero	29,376	Cristallo	98 328
T 10 352/18	Lampada Cero	91,378	Vetro	98 324
T 10 352/24	Lampada Cero	91,378	Vetro	98 331
T 10 399/24	Lampada Cero	380	Cristallo	98 669
P 10 402/17	Lampada Cero	105,379	Cristallo	98 272
P 10 424/17	Lampada Cero	378	Vetro	98 283
T 10 435/17	Lampada Cero	378	Vetro	98 283
T 10 481/20	Lampada Cero	380	Cristallo	98 135
P 10 483/18	Lampada Cero	95,379	Cristallo	98 487
P 10 485/18	Lampada Cero	93,379	Cristallo	98 487
P 10 492/15	Lampada Cero	64,379	Bicchieri	97 726
P 10 492/19	Lampada Cero	64,379	Bicchieri	97 715
T 10 504/15	Lampada Cero	64,379	Bicchieri	97 726
T 10 504/19	Lampada Cero	64,379	Bicchieri	97 715
P 10 561/19	Lampada Cero	89,376	Cristallo	98 873
T 10 563/19	Lampada Cero	89,376	Cristallo	98 873
T 10 563/24	Lampada Cero	89,376	Cristallo	98 545
P 10 565/19	Lampada Cero	376	Cristallo	98 873
T 10 567/19	Lampada Cero	376	Cristallo	98 873
T 10 567/24	Lampada Cero	65,376	Cristallo	98 545
T 10 573/29	Lampada Cero	380	Cristallo	98 146
P 10 577/19	Lampada Cero	175	Cristallo	98 873
T 10 579/19	Lampada Cero	175	Cristallo	98 873

Codice Articolo	Descrizione	Pagina	Accessorio	
			Descrizione	Codice
P 10 581/18	Lampada Cero	79,379	Cristallo	98 487
P 10 584/18	Lampada Cero	77,379	Cristallo	98 487
P 10 588/19	Lampada Cero	154	Cristallo	98 873
T 10 590/19	Lampada Cero	154	Cristallo	98 873
P 10 594/17	Lampada Cero	100,378	Cristallo	98 487
P 10 597/17	Lampada Cero	126	Cristallo	98 487
T 10 606/17	Lampada Cero	100,378	Cristallo	98 487
T 10 607/17	Lampada Cero	126	Cristallo	98 487
T 10 607/25	Lampada Cero	133	Cristallo	98 545
P 10 611/18	Lampada Cero	27,376	Vetro	98 324
P 10 617/16	Lampada Cero	102,379	Bicchieri	97 624
P 10 620/19	Lampada Cero	378	Cristallo	98 165
T 10 622/24	Lampada Cero	27,376	Vetro	98 331
T 10 628/16	Lampada Cero	102,379	Bicchieri	97 624
T 10 630/19	Lampada Cero	378	Cristallo	98 165
T 10 692/18	Lampada Cero	79,379	Cristallo	98 487
T 10 692/24	Lampada Cero	79,379	Cristallo	98 560
T 10 695/18	Lampada Cero	77,379	Cristallo	98 487
T 10 695/24	Lampada Cero	77,379	Cristallo	98 560
T 10 702/18	Lampada Cero	95,379	Cristallo	98 487
T 10 702/24	Lampada Cero	95,379	Cristallo	98 560
T 10 705/18	Lampada Cero	93,379	Cristallo	98 487
T 10 705/24	Lampada Cero	93,379	Cristallo	98 560
T 10 708/29	Lampada Cero	101,380	Cristallo	98 512
P 10 719/16	Lampada Cero	101,379	Cristallo	98 523
T 10 721/16	Lampada Cero	101,379	Cristallo	98 523
T 10 721/18	Lampada Cero	101,379	Cristallo	98 534
P 10 754/18	Lampada Cero	59,379	Cristallo	98 487
T 10 765/18	Lampada Cero	59,379	Cristallo	98 487
P 10 770/19	Lampada Cero	85,378	Cristallo	98 165
T 10 801/24	Lampada Cero	59,380	Cristallo	98 545
T 10 805/24	Lampada Solare	384	Cristallo	98 545
T 10 825/24	Lampada Solare	384	Cristallo	98 425
T 10 827/24	Lampada Cero	98,376	Cristallo	98 425
P 10 828/24	Lampada Cero	98,376	Cristallo	98 425
T 10 829/24	Lampada Cero	83,99,376	Cristallo	98 425
T 10 850/24	Lampada Cero	377	Cristallo	98 260
T 10 860/23	Lampada Cero	380	Cristallo	98 350
T 10 903/24	Lampada Cero	100,380	Cristallo	98 545
P 10 912/18	Lampada Cero	54,378	Vetro	98 324
T 10 925/23	Lampada Cero	53,380	Cristallo	98 556
T 10 933/18	Lampada Cero	54,378	Vetro	98 324
T 10 933/24	Lampada Cero	54,378	Vetro	98 331
11				
T 11 010/20	Lampada Cero	377	Cristallo	98 260
P 11 053/18	Lampada Cero	104,379	Cristallo	98 583
P 11 055/18	Lampada Cero	181	Cristallo	98 583
P 11 061/18	Lampada Cero	135	Cristallo	98 583
T 11 128/23	Lampada Cero	381	Cristallo	98 603
P 11 133/18	Lampada Cero	179	Vetro	98 324
T 11 146/18	Lampada Cero	179	Vetro	98 324
P 11 152/33	Lampada Cero	380	Cristallo	98 625
T 11 163/33	Lampada Cero	380	Cristallo	98 625
T 11 208/20C	Lampada Cero	377	Cristallo	98 385
T 11 208/25C	Lampada Cero	377	Cristallo	98 396
T 11 243/24	Lampada Cero	55,380	Cristallo	98 545
P 11 334/20	Lampada Cero	379	Cristallo	98 192
T 11 345/20	Lampada Cero	379	Cristallo	98 192
T 11 447/24	Lampada Cero	86,380	Cristallo	98 669
T 11 780/20	Lampada Solare	384	Cristallo	98 385
T 11 780/25	Lampada Solare	384	Cristallo	98 396
T 11 782/19	Lampada Solare	189	Cristallo	98 873
T 11 782/24	Lampada Solare	189	Cristallo	98 545
T 11 783/19	Lampada Solare	198	Cristallo	98 873
T 11 783/24	Lampada Solare	198	Cristallo	98 545
T 11 786/19	Lampada Solare	384	Cristallo	98 873

OGGETTISTICA ORNAMENTALE

	Codice Articolo	Descrizione	Pagina	Accessorio	
				Descrizione	Codice
T	11 786/24	Lampada Solare	384	Cristallo	98 545
P	11 892/17	Lampada Cero	55,378	Cristallo	98 487
P	11 892/24	Lampada Cero	75,378	Cristallo	98 545
T	11 904/17	Lampada Cero	55,378	Cristallo	98 487
T	11 904/24	Lampada Cero	75,378	Cristallo	98 545
P	11 915/17	Lampada Cero	193	Cristallo	98 487
T	11 926/17	Lampada Cero	193	Cristallo	98 487
T	11 926/24	Lampada Cero	193	Cristallo	98 545
P	11 930/17	Lampada Cero	97,378	Cristallo	98 487
T	11 932/17	Lampada Cero	97,378	Cristallo	98 487
T	11 932/23	Lampada Cero	97,378	Cristallo	98 545

12

T	12 008/10R	Fioriera	73	Int. Alluminio	96 294
T	12 011/23	Fioriera	39	Int. Plastica	97 043
T	12 021/10R	Fioriera	149	Int. Alluminio	96 290
P	12 038/9	Fioriera	59	Int. Rame	96 304
P	12 038/10	Fioriera	59	Int. Rame	96 315
T	12 046/11	Fioriera	164	Int. Alluminio	96 308
P	12 047/11	Fioriera	164	Int. Alluminio	96 308
T	12 049/9	Fioriera	59	Int. Rame	96 304
T	12 049/10	Fioriera	59	Int. Rame	96 315
T	12 049/20	Fioriera	59	Int. Rame	96 326
T	12 111/12	Fioriera Inc.	78,319	Int. Alluminio	96 320
T	12 112/12	Fioriera Inc.	76,319	Int. Alluminio	96 320
T	12 113/12	Fioriera Inc.	93,320	Int. Alluminio	96 320
T	12 117/12	Fioriera Inc.	180,187	Int. Alluminio	96 322
T	12 118/12	Fioriera Inc.	95,320	Int. Alluminio	96 320
T	12 541/21	Fioriera	75	Int. Plastica	97 043
T	12 811/12	Fioriera	76	Int. Alluminio	96 330
T	12 812/12	Fioriera	78	Int. Alluminio	96 330
T	12 824/11	Fioriera	93	Int. Alluminio	96 062
T	12 826/11	Fioriera	180	Int. Alluminio	96 308
T	12 831/12	Fioriera	95	Int. Alluminio	96 330
T	12 833/12	Fioriera	93	Int. Alluminio	96 330
T	12 835/12	Fioriera	180	Int. Alluminio	96 332

13

T	13 000/07R	Vaso Inc.	319	Int. Alluminio	96 056
T	13 001/03P	Vaso Inc.	318	Int. Plastica	97 032
T	13 001/03R	Vaso Inc.	318	Int. Alluminio	96 050
T	13 003/12	Vaso Inc.	39,318	Int. Rame	96 246
T	13 009/10P	Vaso Inc.	173,187	Int. Plastica	97 032
T	13 011/20	Lamp. Elett. Inc.	319	Fiamma Vetro	98 066
T	13 012/04	Lamp. Elett. Inc.	318	Int. Alluminio	96 056
T	13 016/95R	Lamp. Elett. Inc.	133,140	Int. Alluminio	96 050
T	13 018/10P	Vaso Inc.	73,318	Int. Plastica	97 032
T	13 020/03R	Vaso Inc.	319	Int. Alluminio	96 056
T	13 021/10P	Vaso Inc.	149,164	Int. Plastica	97 032
T	13 026/10P	Vaso Inc.	114	Int. Plastica	97 032
T	13 030/09R	Vaso Inc.	194,198	Int. Alluminio	96 565
T	13 031/09R	Vaso Inc.	78,319	Int. Alluminio	96 057
T	13 034/17	Lamp. Elett. Inc.	319	Fiamma Vetro	98 066
T	13 036/09R	Vaso Inc.	76,319	Int. Alluminio	96 057
T	13 040/09R	Vaso Inc.	195,198	Int. Alluminio	96 565
T	13 043/09P	Vaso Inc.	93,320	Int. Plastica	97 065
T	13 043/09R	Vaso Inc.	93,320	Int. Alluminio	96 057
T	13 045/09	Vaso Inc.	180,187	Int. Plastica	97 068
T	13 046/09	Vaso Inc.	95,320	Int. Alluminio	96 057
T	13 055/07P	Vaso Inc.	81,319	Int. Plastica	97 464
T	13 057/4	Vaso Inc.	28,318	Int. Rame	96 485
T	13 060/09	Vaso Inc.	164	Int. Alluminio	96 610
T	13 062/10P	Vaso Inc.	113	Int. Plastica	97 032
T	13 065/25	Lamp. Elett. Inc.	81,319	Fiamma Vetro	98 088
T	13 076/10	Portina	326	Cristallo	98 027
T	13 076/12	Portina	326	Cristallo	98 139

OGGETTISTICA ORNAMENTALE

	Codice Articolo	Descrizione	Pagina	Accessorio	
				Descrizione	Codice
T	13 077/04P	Vaso Inc.	321	Int. Plastica	97 464
T	13 079/10P	Vaso Inc.	116	Int. Plastica	97 032
T	13 080/14	Lamp. Elett. Inc.	321	Fiamma Vetro	98 066
T	13 084/10P	Vaso Inc.	115	Int. Plastica	97 032
T	13 088/11	Lamp. Elett. Inc.	323	Cristallo Vetro	98 122 98 953
T	13 093/10P	Vaso Inc.	112	Int. Plastica	97 032
T	13 096/10P	Vaso Inc.	118	Int. Plastica	97 032
T	13 099/13	Lamp. Cero Inc.	323	Portacero Rame Vetro	96 432 98 953
T	13 100/08P	Vaso Inc.	323	Int. Plastica	97 065
T	13 102/02	Portina	326	Cristallo	98 137
T	13 102/06	Portina	326	Crist. Conico	98 237
T	13 102/08	Portina	326	Crist. Conico	98 247
T	13 102/10	Portina	326	Portlamp. All.	96 437
T	13 107/7	Vaso Inc.	42,318	Int. Rame	96 714
T	13 124/17	Lamp. Cero Inc.	323	Portacero Rame Vetro	96 432 98 148
T	13 128/05	Vaso Inc.	323	Int. Plastica	97 065
T	13 130/02	Portina	326	Pirex	98 872
T	13 131/05	Portina	326	Cristallo	98 351
T	13 135/05	Portina	327	Cristallo	98 343
T	13 136/06	Portina	141	Crist. Conico	98 237
T	13 136/08	Portina	141	Crist. Conico	98 247
T	13 136/10	Portina	141	Portlamp. All.	96 437
T	13 136/12	Portina	141	Cristallo	98 137
T	13 137/10P	Vaso Inc.	117	Int. Plastica	97 032
T	13 138/04	Vaso Inc.	323	Int. Plastica	97 065
T	13 141/06	Portina	163	Crist. Conico	98 237
T	13 141/08	Portina	163	Crist. Conico	98 247
T	13 141/10	Portina	163	Portlamp. All.	96 437
T	13 141/12	Portina	163	Cristallo	98 137
T	13 142/05	Portina	327	Cristallo	98 348
T	13 161/05	Portina	327	Cristallo	98 355
T	13 162/10P	Vaso Inc.	111	Int. Plastica	97 032
T	13 163/05	Portina	327	Cristallo	98 360
T	13 165/04P	Vaso Inc.	321	Int. Plastica	97 065
T	13 165/04R	Vaso Inc.	321	Int. Alluminio	96 057
T	13 167/03	Portina	326	Cristallo	98 274
T	13 168/03	Portina	326	Cristallo	98 280
T	13 169/03	Portina	326	Cristallo	98 286
T	13 170/05	Portina	327	Cristallo	98 370
T	13 175/03	Portina	326	Cristallo	98 277
T	13 176/03	Portina	326	Cristallo	98 281
T	13 177/03	Portina	326	Cristallo	98 287
T	13 178/05	Portina	327	Cristallo	98 368
T	13 180/06	Portina	327	Cristallo	98 292
T	13 180/08	Portina	327	Cristallo	98 392
T	13 180/12	Portina	327	Cristallo	98 492
T	13 181/10P	Vaso Inc.	119	Int. Plastica	97 032
T	13 185/06	Portina	141	Cristallo	98 292
T	13 185/08	Portina	141	Cristallo	98 392
T	13 185/12	Portina	141	Cristallo	98 492
T	13 187/55	Vaso Inc.	321	Int. Plastica	97 032
T	13 190/06	Portina	163	Cristallo	98 292
T	13 190/08	Portina	163	Cristallo	98 392
T	13 190/12	Portina	163	Cristallo	98 492
T	13 195/06	Portina	327	Cristallo	98 290
T	13 195/08	Portina	327	Cristallo	98 390
T	13 195/12	Portina	327	Cristallo	98 490
T	13 200/06	Portina	141	Cristallo	98 290
T	13 200/08	Portina	141	Cristallo	98 390
T	13 200/12	Portina	141	Cristallo	98 490
T	13 205/06	Portina	163	Cristallo	98 290
T	13 205/08	Portina	163	Cristallo	98 390
T	13 205/12	Portina	163	Cristallo	98 490
T	13 210/08	Portina	327	Cristallo	98 006
T	13 215/08	Portina	141	Cristallo	98 006

OGGETTISTICA ORNAMENTALE
OGGETTISTICA ORNAMENTALE

Codice Articolo	Descrizione	Pagina	Accessorio	
			Descrizione	Codice
T 13 220/08	Portina	163	Cristallo	98 006
T 13 225/08	Portina	327	Crist. Irid.	98 106
T 13 230/08	Portina	141	Crist. Irid.	98 106
T 13 235/08	Portina	163	Crist. Irid.	98 106
T 13 245/95	Vaso Inc.	75,319	Int. Alluminio	96 050
T 13 247/17	Vaso Inc.	322	Int. Alluminio	96 003
T 13 247/23	Vaso Inc.	322	Int. Alluminio	96 056
T 13 247/27P	Vaso Inc.	322	Int. Plastica	97 032
T 13 247/27R	Vaso Inc.	322	Int. Rame	96 496
T 13 247/29P	Vaso Inc.	322	Int. Plastica	97 065
T 13 247/29R	Vaso Inc.	322	Int. Alluminio	96 057
T 13 249/15R	Vaso Inc.	322	Int. Rame	96 005
T 13 250/23R	Vaso Inc.	140	Int. Alluminio	96 056
T 13 250/27R	Vaso Inc.	140	Int. Rame	96 496
T 13 251/15	Vaso Inc.	322	Int. Rame	96 005
T 13 258/15R	Vaso Inc.	140	Int. Rame	96 005
T 13 263/03	Vaso Inc.	322	Int. Rame	96 636
T 13 265/03P	Vaso Inc.	322	Int. Plastica	97 032
T 13 265/03R	Vaso Inc.	322	Int. Alluminio	96 056
T 13 267/04	Vaso Inc.	322	Int. Rame	96 638
T 13 363/06	Vaso Inc.	320	Int. Alluminio	96 056
T 13 405/95	Vaso Inc.	193,198	Int. Alluminio	96 275
T 13 422/11P	Vaso Inc.	88,321	Int. Plastica	97 464
T 13 422/11R	Vaso Inc.	88,321	Int. Rame	96 496
T 13 442/11P	Vaso Inc.	164	Int. Plastica	97 468
T 13 442/11R	Vaso Inc.	164	Int. Alluminio	96 532
T 13 511/12	Lamp. Cero Inc.	88,321	Int. Alluminio	96 051
			Cristallo	98 831
T 13 512/22	Lamp. Elett. Inc.	39,318	Fiamma Vetro	98 060
T 13 516/17	Lamp. Elett. Inc.	28,318	Fiamma Vetro	98 066
T 13 533/17	Lamp. Elett. Inc.	318	Fiamma Vetro	98 066
T 13 551/15	Lamp. Elett. Inc.	318	Fiamma Vetro	98 060
T 13 609/10	Lamp. Elett. Inc.	321	Int. Alluminio	96 051
			Cristallo	98 831
T 13 611/12	Lamp. Solare	384	Cristallo	98 831
T 13 623/21	Lamp. Elett. Inc.	76,319	Fiamma Vetro	98 066
T 13 625/21	Lamp. Elett. Inc.	78,319	Fiamma Vetro	98 066
T 13 628/21	Lamp. Elett. Inc.	194,198	Fiamma Vetro	98 066
T 13 634/21	Lamp. Elett. Inc.	93,320	Fiamma Vetro	98 066
T 13 636/21	Lamp. Elett. Inc.	95,320	Fiamma Vetro	98 066
T 13 638/21	Lamp. Elett. Inc.	195,198	Fiamma Vetro	98 066
T 13 639/21	Lamp. Elett. Inc.	180,187	Fiamma Vetro	98 066
T 13 650/21	Lamp. Elett. Inc.	164	Fiamma Vetro	98 066
T 13 666/16	Lamp. Elett. Inc.	321	Fiamma Vetro	98 015
T 13 746/21	Lamp. Elett. Inc.	75,319	Fiamma Vetro	98 060
T 13 750/11	Lamp. Elett. Inc.	322	Fiamma Vetro	98 055
T 13 750/17	Lamp. Elett. Inc.	322	Fiamma Vetro	98 066
T 13 755/11	Lamp. Elett. Inc.	140	Fiamma Vetro	98 055
T 13 755/17	Lamp. Elett. Inc.	140	Fiamma Vetro	98 066
T 13 781/15	Lamp. Elett. Inc.	322	Fiamma Vetro	98 055
T 13 783/21	Lamp. Elett. Inc.	133,140	Fiamma Vetro	98 060
T 13 804/21	Lamp. Elett. Inc.	193,198	Fiamma Vetro	98 060
T 13 814/10	Lamp. Cero Inc.	323	Int. Alluminio	96 051
			Cristallo	98 950
T 13 816/10	Lamp. Elett. Inc.	323	Cristallo	98 950
			Cristallo	98 982
T 13 820/10	Vaso Inc.	323	Int. Plastica	97 065
			Cristallo	98 950
T 13 822/04	Vaso Inc.	323	Int. Plastica	97 065
T 13 921/20	Lamp. Elett. Inc.	320	Fiamma Vetro	98 066

14

P 14 130/09	Monoblocco	35	Int. Rame	96 280
			Fiamma Vetro	98 055
P 14 130/11	Monoblocco	35	Int. Rame	96 280
			Fiamma Vetro	98 055
P 14 290/09	Monoblocco	34	Int. Rame	96 280

Codice Articolo	Descrizione	Pagina	Accessorio	
			Descrizione	Codice
P 14 290/11	Monoblocco	34	Fiamma Vetro	98 055
			Int. Rame	96 280
			Fiamma Vetro	98 055

15

P 15 000	Ritorno alla Natura	252		
P 15 010	Ritorno alla Natura	252		
P 15 020	Ritorno alla Natura	253		
P 15 021	Ritorno alla Natura	549	Int. Plastica	97 058
P 15 025	Ritorno alla Natura	253		
P 15 030	Soffio	261		
P 15 031	Soffio	549	Int. Plastica	97 058
P 15 040	Tempo	257		
P 15 041	Tempo	549	Int. Plastica	96 022
			Fiamma in Plex	97 515
P 15 051	Continuità Bianca	550		
P 15 052	Continuità Beige	550		
P 15 053	Continuità Blu	550		
P 15 061	Anima	549	Int. Plastica	97 058

19

P 19 001/09	Cornice	114		
P 19 001/11	Cornice	114		
P 19 002/09	Cornice	24,339		
P 19 002/11	Cornice	24,339		
P 19 003/06	Cornice	38,302,339		
P 19 003/07	Cornice	38,302,339		
P 19 003/08	Cornice	38,302,339		
P 19 003/09	Cornice	38,302,339		
P 19 003/11	Cornice	38,302,339		
P 19 003/13	Cornice	38,339		
P 19 005/09	Cornice	28,339		
P 19 005/11	Cornice	28,339		
T 19 007/09	Cornice	48,344		
T 19 007/11	Cornice	48,344		
P 19 008/09	Cornice	29,339		
P 19 008/11	Cornice	29,339		
P 19 010/09	Cornice	125,138		
P 19 010/11	Cornice	125,138		
P 19 010/13	Cornice	125,138		
P 19 011/09	Cornice	48,340		
P 19 011/11	Cornice	48,340		
P 19 011/13	Cornice	48,340		
P 19 013/09	Cornice	50,340		
P 19 013/11	Cornice	50,340		
P 19 013/13	Cornice	50,340		
P 19 014/09	Cornice	25,339		
P 19 014/11	Cornice	25,339		
T 19 017/09	Cornice	38,344		
T 19 017/11	Cornice	38,344		
P 19 018/09	Cornice	69,340		
P 19 018/11	Cornice	69,340		
P 19 019/09	Cornice	147,160		
P 19 019/11	Cornice	147,160		
P 19 019/13	Cornice	147,160		
P 19 020/08	Cornice	69,340		
P 19 021/08	Cornice	42,341		
P 19 021/09	Cornice	42,341		
P 19 021/11	Cornice	42,341		
P 19 022/09	Cornice	31,339		
P 19 022/11	Cornice	31,339		
P 19 024/09	Cornice	30,339		
P 19 024/11	Cornice	30,339		
P 19 029/09	Cornice	70,340		

OGGETTISTICA ORNAMENTALE

	Codice Articolo	Descrizione	Pagina	Accessorio	
				Descrizione	Codice
P	19 029/11	Cornice	70,340		
P	19 032/09	Cornice	44,341		
P	19 032/11	Cornice	44,341		
P	19 033/09	Cornice	172,183		
P	19 033/11	Cornice	172,183		
P	19 041/09	Cornice	124,138		
P	19 041/11	Cornice	124,138		
P	19 042/09	Cornice	32,340		
P	19 042/11	Cornice	32,340		
P	19 044/09	Cornice	113		
P	19 044/11	Cornice	113		
P	19 045/09	Cornice	45,341		
P	19 045/11	Cornice	45,341		
P	19 046/09	Cornice	116		
P	19 046/11	Cornice	116		
P	19 047/09	Cornice	115		
P	19 047/11	Cornice	115		
P	19 050/09	Cornice	41,340		
P	19 050/11	Cornice	41,340		
P	19 052/09	Cornice	112		
P	19 052/11	Cornice	112		
P	19 054/08	Cornice	70,340		
P	19 057/09	Cornice	118		
P	19 057/11	Cornice	118		
P	19 058/05	Cornice	342		
P	19 058/07	Cornice	342		
P	19 058/08	Cornice	342		
P	19 058/09	Cornice	342		
P	19 058/11	Cornice	342		
P	19 061/09	Cornice	117		
P	19 061/11	Cornice	117		
P	19 063/07	Cornice	26,339		
P	19 063/08	Cornice	26,339		
P	19 063/09	Cornice	26,339		
P	19 063/11	Cornice	26,339		
P	19 063/13	Cornice	26,339		
P	19 066/09	Cornice	111		
P	19 066/11	Cornice	111		
P	19 070/08	Cornice	172,183		
P	19 071/09	Cornice	343		
P	19 071/11	Cornice	343		
P	19 073/09	Cornice	119		
P	19 073/11	Cornice	119		
P	19 078/08	Cornice	71		
P	19 078/09	Cornice	71		
P	19 078/11	Cornice	71		
T	19 082/09	Cornice	345		
T	19 082/11	Cornice	345		
P	19 093/09	Cornice	343		
P	19 093/11	Cornice	343		
P	19 093/13	Cornice	343		
P	19 101/09	Cornice	84,96,342		
P	19 101/11	Cornice	84,96,342		
P	19 101/13	Cornice	84,96,342		
P	19 106/09	Cornice	43,341		
P	19 106/11	Cornice	43,341		
P	19 116/09	Cornice	62,343		
P	19 116/11	Cornice	62,343		
P	19 116/13	Cornice	62,343		
P	19 123/09	Cornice	174,183		
P	19 123/11	Cornice	174,183		
P	19 123/13	Cornice	174,183		
P	19 125/09	Cornice	151,160		
P	19 125/11	Cornice	151,160		
P	19 125/13	Cornice	151,160		
T	19 181/09	Cornice	89,345		
T	19 181/11	Cornice	89,345		
P	19 190/09	Cornice	130,138		

OGGETTISTICA ORNAMENTALE

	Codice Articolo	Descrizione	Pagina	Accessorio	
				Descrizione	Codice
P	19 190/11	Cornice	130,138		
P	19 195/09	Cornice	52,343		
P	19 195/11	Cornice	52,343		
P	19 218/09	Cornice	63,343		
P	19 218/11	Cornice	63,343		
P	19 231/09	Cornice	342		
P	19 231/11	Cornice	342		
P	19 253/09	Cornice	102,343		
P	19 253/11	Cornice	102,343		
P	19 275/09	Cornice	101,342		
P	19 275/11	Cornice	101,342		
T	19 286/09	Cornice	345		
T	19 286/11	Cornice	345		
P	19 305/09	Cornice	160		
P	19 305/11	Cornice	160		
P	19 311/09	Cornice	343		
P	19 311/11	Cornice	343		
P	19 350/09	Cornice	126,138		
P	19 350/11	Cornice	126,138		
P	19 352/08	Cornice	183		
P	19 352/09	Cornice	183		
P	19 352/11	Cornice	183		
P	19 352/13	Cornice	183		
P	19 352/18	Cornice	183		
P	19 355/05	Cornice	342		
P	19 355/06	Cornice	342		
P	19 355/07	Cornice	342		
P	19 355/08	Cornice	342		
P	19 355/09	Cornice	342		
P	19 355/11	Cornice	342		
P	19 355/13	Cornice	342		
P	19 355/18	Cornice	342		
P	19 359/07	Cornice	203		
P	19 359/08	Cornice	203		
P	19 359/09	Cornice	203		
P	19 359/11	Cornice	203		
P	19 359/13	Cornice	203		
P	19 360/09	Cornice	195,197		
P	19 360/11	Cornice	195,197		
P	19 361/05	Cornice	156,160		
P	19 361/06	Cornice	156,160		
P	19 361/07	Cornice	156,160		
P	19 361/08	Cornice	156,160		
P	19 361/09	Cornice	156,160		
P	19 361/11	Cornice	156,160		
P	19 361/13	Cornice	156,160		
P	19 365/09	Cornice	47,340		
P	19 365/11	Cornice	47,340		
T	19 366/09	Cornice	344		
T	19 366/11	Cornice	344		
T	19 366/13	Cornice	344		
T	19 366/18	Cornice	344		
P	19 377/07	Cornice	342		
P	19 377/08	Cornice	342		
P	19 377/09	Cornice	342		
P	19 377/11	Cornice	342		
P	19 377/13	Cornice	342		
P	19 377/18	Cornice	342		
P	19 534/09	Cornice	176,183		
P	19 534/11	Cornice	176,183		
P	19 534/13	Cornice	176,183		
P	19 537/09	Cornice	57		
P	19 537/11	Cornice	57		
P	19 537/13	Cornice	57		
P	19 539/09	Cornice	146,160		
P	19 539/11	Cornice	146,160		
P	19 539/13	Cornice	146,160		
P	19 559/09	Cornice	77,341		

OGGETTISTICA ORNAMENTALE

Codice Articolo	Descrizione	Pagina	Accessorio	
			Descrizione	Codice
P 19 559/11	Cornice	77,341		
P 19 559/13	Cornice	77,341		
P 19 590/09	Cornice	132,138		
P 19 590/11	Cornice	132,138		
P 19 595/10	Cornice	343		
P 19 595/12	Cornice	343		
T 19 602/09	Cornice	77,345		
T 19 602/11	Cornice	77,345		
T 19 602/13	Cornice	77,345		
P 19 617/09	Cornice	192,197		
P 19 617/11	Cornice	192,197		
P 19 617/13	Cornice	192,197		
T 19 639/09	Cornice	344		
T 19 639/11	Cornice	344		
T 19 639/13	Cornice	344		
T 19 639/18	Cornice	344		
P 19 652/12	Cornice	343		
P 19 652/14	Cornice	343		
P 19 660/09	Cornice	80,343		
P 19 660/11	Cornice	80,343		
P 19 710/09	Cornice	341		
P 19 710/11	Cornice	341		
P 19 715/07	Cornice	343		
P 19 715/08	Cornice	343		
P 19 715/09	Cornice	343		
P 19 715/11	Cornice	343		
P 19 740/08	Cornice	203		
P 19 740/09	Cornice	203		
P 19 740/11	Cornice	203		
P 19 740/13	Cornice	203		
P 19 760/08	Cornice	150,160		
P 19 760/09	Cornice	150,160		
P 19 760/11	Cornice	150,160		
P 19 760/13	Cornice	150,160		
P 19 766/07	Cornice	123,138		
P 19 766/08	Cornice	123,138		
P 19 766/09	Cornice	123,138		
P 19 766/11	Cornice	123,138		
P 19 766/13	Cornice	123,138		
P 19 768/06	Cornice	303,342		
P 19 768/07	Cornice	303,342		
P 19 768/08	Cornice	303,342		
P 19 768/09	Cornice	303,342		
P 19 768/11	Cornice	303,342		
P 19 768/13	Cornice	303,342		
P 19 768/18	Cornice	303,342		
P 19 770/08	Cornice	167,169		
P 19 770/09	Cornice	167,169		
P 19 770/11	Cornice	167,169		
P 19 780/06	Cornice	191,197		
P 19 780/07	Cornice	191,197		
P 19 780/08	Cornice	191,197		
P 19 780/09	Cornice	191,197		
P 19 780/11	Cornice	191,197		
P 19 780/13	Cornice	191,197		
P 19 780/18	Cornice	191,197		
P 19 787/09	Cornice	341		
P 19 787/11	Cornice	341		
P 19 787/13	Cornice	341		
P 19 787/18	Cornice	341		
P 19 789/09	Cornice	341		
P 19 789/11	Cornice	341		
P 19 789/13	Cornice	341		
P 19 789/18	Cornice	341		
P 19 790/09	Cornice	94,342		
P 19 790/11	Cornice	94,342		
P 19 790/13	Cornice	94,342		
P 19 801/09	Cornice	341		

OGGETTISTICA ORNAMENTALE

Codice Articolo	Descrizione	Pagina	Accessorio	
			Descrizione	Codice
P 19 801/11	Cornice	341		
P 19 820/09	Cornice	46,340		
P 19 820/11	Cornice	46,340		
P 19 823/07	Cornice	64,99,342		
P 19 823/09	Cornice	64,99,342		
P 19 823/11	Cornice	64,99,342		
P 19 823/13	Cornice	64,99,342		
P 19 823/18	Cornice	64,99,342		
P 19 826/09	Cornice	183		
P 19 826/11	Cornice	183		
P 19 826/13	Cornice	183		
P 19 834/09	Cornice	65,343		
P 19 834/11	Cornice	65,343		
P 19 845/09	Cornice	343		
P 19 845/11	Cornice	343		
T 19 856/09	Cornice	345		
T 19 856/11	Cornice	345		
T 19 856/13	Cornice	345		
T 19 856/18	Cornice	345		
P 19 886/09	Cornice	152,160		
P 19 886/11	Cornice	152,160		
P 19 886/13	Cornice	152,160		
T 19 892/09	Cornice	74,345		
T 19 892/11	Cornice	74,345		
T 19 892/13	Cornice	74,345		

20

T 20 110/09	Composizione	423	Fiamma Vetro	98 066
T 20 110/11	Composizione	423	Fiamma Vetro	98 066
T 20 117/15	Composizione	423	Fiamma Vetro	98 055
T 20 122/09	Composizione	423	Fiamma Vetro	98 066
T 20 122/11	Composizione	423	Fiamma Vetro	98 066
T 20 131/15	Composizione	423	Fiam. Crist.ø 5	98 117
T 20 143/15	Composizione	423	Fiamma Vetro	98 066
T 20 206/0	Composizione	423		

21

P 21 001/09	Cornice	48,340		
P 21 001/10	Cornice	48,340		
P 21 001/11	Cornice	48,340		
P 21 001/13	Cornice	48,340		
P 21 003/09	Cornice	50,340		
P 21 003/10	Cornice	50,340		
P 21 003/11	Cornice	50,340		
P 21 003/13	Cornice	50,340		
P 21 004/09	Cornice	42,340		
P 21 004/11	Cornice	42,340		
P 21 005/09	Cornice	69,340		
P 21 005/11	Cornice	69,340		
P 21 006/09	Cornice	114		
P 21 006/10	Cornice	114		
P 21 006/11	Cornice	114		
P 21 007/09	Cornice	38,302,339		
P 21 007/10	Cornice	38,302,339		
P 21 007/11	Cornice	38,302,339		
P 21 007/13	Cornice	38,339		
P 21 009/09	Cornice	147,160		
P 21 009/10	Cornice	147,160		
P 21 009/11	Cornice	147,160		
P 21 009/13	Cornice	147,160		
P 21 010/09	Cornice	28,339		
P 21 010/10	Cornice	28,339		
P 21 010/11	Cornice	28,339		
P 21 012/09	Cornice	26,339		
P 21 012/10	Cornice	26,339		
P 21 012/11	Cornice	26,339		

OGGETTISTICA ORNAMENTALE

	Codice Articolo	Descrizione	Pagina	Accessorio	
				Descrizione	Codice
P	21 012/13	Cornice	26,339		
T	21 014/09	Cornice	48,344		
T	21 014/10	Cornice	48,344		
T	21 014/11	Cornice	48,344		
P	21 015/07	Cornice	303,342		
P	21 015/08	Cornice	303,342		
P	21 015/09	Cornice	303,342		
P	21 015/10	Cornice	303,342		
P	21 015/11	Cornice	303,342		
P	21 015/13	Cornice	303,342		
P	21 015/18	Cornice	303,342		
P	21 017/08	Cornice	123,138		
P	21 017/09	Cornice	123,138		
P	21 017/10	Cornice	123,138		
P	21 017/11	Cornice	123,138		
P	21 017/13	Cornice	123,138		
P	21 018/09	Cornice	29,339		
P	21 018/10	Cornice	29,339		
P	21 018/11	Cornice	29,339		
P	21 021/09	Cornice	70,340		
P	21 021/11	Cornice	70,340		
P	21 023/09	Cornice	31,339		
P	21 023/10	Cornice	31,339		
P	21 023/11	Cornice	31,339		
P	21 024/08	Cornice	150,160		
P	21 024/09	Cornice	150,160		
P	21 024/10	Cornice	150,160		
P	21 024/11	Cornice	150,160		
P	21 024/13	Cornice	150,160		
P	21 025/09	Cornice	30,339		
P	21 025/10	Cornice	30,339		
P	21 025/11	Cornice	30,339		
P	21 028/07	Cornice	191,197		
P	21 028/08	Cornice	191,197		
P	21 028/09	Cornice	191,197		
P	21 028/10	Cornice	191,197		
P	21 028/11	Cornice	191,197		
P	21 028/13	Cornice	191,197		
P	21 028/18	Cornice	191,197		
P	21 030/08	Cornice	203		
P	21 030/09	Cornice	203		
P	21 030/10	Cornice	203		
P	21 030/11	Cornice	203		
P	21 030/13	Cornice	203		
P	21 032/08	Cornice	167,169		
P	21 032/09	Cornice	167,169		
P	21 032/10	Cornice	167,169		
P	21 032/11	Cornice	167,169		
T	21 034/09	Cornice	38,344		
T	21 034/10	Cornice	38,344		
T	21 034/11	Cornice	38,344		
P	21 035/09	Cornice	41,340		
P	21 035/11	Cornice	41,340		
P	21 038/09	Cornice	172,183		
P	21 038/11	Cornice	172,183		
T	21 043/19	Supporto	344		
T	21 043/22	Supporto	344		
P	21 044/09	Cornice	44,340		
P	21 044/11	Cornice	44,340		
P	21 047/09	Cornice	124,138		
P	21 047/10	Cornice	124,138		
P	21 047/11	Cornice	124,138		
P	21 048/09	Cornice	125,138		
P	21 048/10	Cornice	125,138		
P	21 048/11	Cornice	125,138		
P	21 048/13	Cornice	125,138		
P	21 050/09	Cornice	45,340		
P	21 050/11	Cornice	45,340		

OGGETTISTICA ORNAMENTALE

	Codice Articolo	Descrizione	Pagina	Accessorio	
				Descrizione	Codice
P	21 051/08	Cornice	69,340		
P	21 052/09	Cornice	343		
P	21 052/10	Cornice	343		
P	21 052/11	Cornice	343		
P	21 052/13	Cornice	343		
P	21 054/09	Cornice	32,340		
P	21 054/11	Cornice	32,340		
P	21 059/08	Cornice	70,340		
P	21 061/09	Cornice	113		
P	21 061/10	Cornice	113		
P	21 061/11	Cornice	113		
P	21 062/08	Cornice	172,183		
T	21 063/09	Cornice	345		
T	21 063/10	Cornice	345		
T	21 063/11	Cornice	345		
T	21 063/13	Cornice	345		
P	21 069/09	Cornice	116		
P	21 069/10	Cornice	116		
P	21 069/11	Cornice	116		
P	21 071/09	Cornice	115		
P	21 071/10	Cornice	115		
P	21 071/11	Cornice	115		
P	21 074/09	Cornice	343		
P	21 074/10	Cornice	343		
P	21 076/09	Cornice	112		
P	21 076/10	Cornice	112		
P	21 076/11	Cornice	112		
P	21 079/09	Cornice	94,342		
P	21 079/10	Cornice	94,342		
P	21 079/11	Cornice	94,342		
P	21 079/13	Cornice	94,342		
P	21 080/09	Cornice	118		
P	21 080/10	Cornice	118		
P	21 080/11	Cornice	118		
P	21 081/09	Cornice	84,96,342		
P	21 081/10	Cornice	84,96,342		
P	21 081/11	Cornice	84,96,342		
P	21 081/13	Cornice	84,96,342		
P	21 092/09	Cornice	117		
P	21 092/10	Cornice	117		
P	21 092/11	Cornice	117		
P	21 095/09	Cornice	111		
P	21 095/10	Cornice	111		
P	21 095/11	Cornice	111		
P	21 096/09	Cornice	342		
P	21 096/10	Cornice	342		
P	21 098/09	Cornice	119		
P	21 098/10	Cornice	119		
P	21 098/11	Cornice	119		
P	21 112/08	Cornice	71		
P	21 112/09	Cornice	71		
P	21 112/10	Cornice	71		
P	21 112/11	Cornice	71		
P	21 119/09	Cornice	101,342		
P	21 119/10	Cornice	101,342		
P	21 119/11	Cornice	101,342		
T	21 121/09	Cornice	345		
T	21 121/10	Cornice	345		
T	21 121/11	Cornice	345		
P	21 132/09	Cornice	63,343		
P	21 132/10	Cornice	63,343		
P	21 132/11	Cornice	63,343		
T	21 161/09	Cornice	89,345		
T	21 161/10	Cornice	89,345		
T	21 161/11	Cornice	89,345		
P	21 176/09	Cornice	343		
P	21 176/10	Cornice	343		
P	21 176/13	Cornice	343		

OGGETTISTICA ORNAMENTALE

Codice Articolo	Descrizione	Pagina	Accessorio	
			Descrizione	Codice
P 21 183/09	Cornice	174,183		
P 21 183/10	Cornice	174,183		
P 21 183/11	Cornice	174,183		
P 21 183/13	Cornice	174,183		
P 21 185/09	Cornice	151,160		
P 21 185/10	Cornice	151,160		
P 21 185/11	Cornice	151,160		
P 21 185/13	Cornice	151,160		
P 21 212/08	Cornice	342		
P 21 212/09	Cornice	342		
P 21 212/10	Cornice	342		
P 21 212/11	Cornice	342		
P 21 212/13	Cornice	342		
P 21 212/18	Cornice	342		
P 21 214/08	Cornice	203		
P 21 214/09	Cornice	203		
P 21 214/10	Cornice	203		
P 21 214/11	Cornice	203		
P 21 214/13	Cornice	203		
P 21 216/09	Cornice	195,197		
P 21 216/10	Cornice	195,197		
P 21 216/11	Cornice	195,197		
P 21 217/08	Cornice	183		
P 21 217/09	Cornice	183		
P 21 217/10	Cornice	183		
P 21 217/11	Cornice	183		
P 21 217/13	Cornice	183		
P 21 217/18	Cornice	183		
P 21 219/08	Cornice	156,160		
P 21 219/09	Cornice	156,160		
P 21 219/10	Cornice	156,160		
P 21 219/11	Cornice	156,160		
P 21 219/13	Cornice	156,160		
P 21 220/09	Cornice	126,138		
P 21 220/10	Cornice	126,138		
P 21 220/11	Cornice	126,138		
T 21 223/09	Cornice	344		
T 21 223/10	Cornice	344		
T 21 223/11	Cornice	344		
T 21 223/13	Cornice	344		
T 21 223/18	Cornice	344		
P 21 228/09	Cornice	47,340		
P 21 228/10	Cornice	47,340		
P 21 230/09	Cornice	160		
P 21 230/10	Cornice	160		
P 21 230/11	Cornice	160		
P 21 234/09	Cornice	343		
P 21 234/10	Cornice	343		
P 21 234/11	Cornice	343		
P 21 256/07	Cornice	342		
P 21 256/08	Cornice	342		
P 21 256/09	Cornice	342		
P 21 256/10	Cornice	342		
P 21 256/11	Cornice	342		
P 21 256/13	Cornice	342		
P 21 256/18	Cornice	342		
P 21 300/09	Cornice	132,138		
P 21 300/10	Cornice	132,138		
P 21 300/11	Cornice	132,138		
P 21 305/09	Cornice	43,340		
P 21 305/11	Cornice	43,340		
T 21 369/25	Libro	303		
T 21 369/35	Libro	303		
T 21 427/0	Targa	345		
P 21 451/09	Cornice	77,340		
P 21 451/10	Cornice	77,340		
P 21 451/11	Cornice	77,340		
P 21 451/13	Cornice	77,340		

OGGETTISTICA ORNAMENTALE

Codice Articolo	Descrizione	Pagina	Accessorio	
			Descrizione	Codice
P 21 473/09	Cornice	57,340		
P 21 473/10	Cornice	57,340		
P 21 473/11	Cornice	57,340		
P 21 473/13	Cornice	57,340		
P 21 476/09	Cornice	146,160		
P 21 476/10	Cornice	146,160		
P 21 476/11	Cornice	146,160		
P 21 476/13	Cornice	146,160		
P 21 477/09	Cornice	176,183		
P 21 477/10	Cornice	176,183		
P 21 477/11	Cornice	176,183		
P 21 477/13	Cornice	176,183		
P 21 500/09	Cornice	80,343		
P 21 500/10	Cornice	80,343		
P 21 518/09	Cornice	192,197		
P 21 518/10	Cornice	192,197		
P 21 518/11	Cornice	192,197		
P 21 518/13	Cornice	192,197		
T 21 542/09	Cornice	344		
T 21 542/10	Cornice	344		
T 21 542/11	Cornice	344		
T 21 542/13	Cornice	344		
T 21 542/18	Cornice	344		
P 21 553/09	Cornice	343		
P 21 553/10	Cornice	343		
P 21 564/09	Cornice	341		
P 21 564/10	Cornice	341		
P 21 564/11	Cornice	341		
P 21 564/13	Cornice	341		
P 21 564/18	Cornice	341		
P 21 566/09	Cornice	341		
P 21 566/10	Cornice	341		
P 21 566/11	Cornice	341		
P 21 566/13	Cornice	341		
P 21 566/18	Cornice	341		
P 21 586/09	Cornice	341		
P 21 586/10	Cornice	341		
T 21 609/09	Cornice	345		
T 21 609/10	Cornice	345		
T 21 609/11	Cornice	345		
T 21 609/13	Cornice	345		
T 21 609/18	Cornice	345		
P 21 620/09	Cornice	46,340		
P 21 620/10	Cornice	46,340		
P 21 641/09	Cornice	152,160		
P 21 641/10	Cornice	152,160		
P 21 641/11	Cornice	152,160		
P 21 641/13	Cornice	152,160		
T 21 646/09	Cornice	77,345		
T 21 646/10	Cornice	77,345		
T 21 646/11	Cornice	77,345		
T 21 646/13	Cornice	77,345		
T 21 651/09	Cornice	74,345		
T 21 651/10	Cornice	74,345		
T 21 651/11	Cornice	74,345		
T 21 651/13	Cornice	74,345		
P 21 666/12	Libro	303		
P 21 666/17	Libro	303		
T 21 677/12	Libro	303		
T 21 677/17	Libro	303		
P 21 702/12	Libro	303		
P 21 702/17	Libro	303		
T 21 713/12	Libro	303		
T 21 713/17	Libro	303		
T 21 862/18	Libro	302		
T 21 862/26	Libro	302		
P 21 873/18	Libro	302		
P 21 873/26	Libro	302		

OGGETTISTICA ORNAMENTALE

	Codice Articolo	Descrizione	Pagina	Accessorio	
				Descrizione	Codice
P	21 920/09	Cornice	341		
P	21 920/10	Cornice	341		
P	21 920/11	Cornice	341		
P	21 996/0	Snodo	344		

22

P	22 000/75	Pergamena	305		
P	22 000/100	Pergamena	305		
P	22 000/105	Pergamena	305		
P	22 000/140	Pergamena	305		
P	22 018/210	Pergamena	305		
P	22 018/250	Pergamena	305		
P	22 018/310	Pergamena	305		
P	22 030/75	Pergamena	307		
P	22 030/100	Pergamena	307		
P	22 040/75	Pergamena	307		
P	22 040/100	Pergamena	307		
P	22 042/70	Pergamena	305,563		
P	22 042/100	Pergamena	305		
P	22 042/110	Pergamena	305		
P	22 042/150	Pergamena	305		
P	22 042/180	Pergamena	305		
P	22 053/30	Targa	352		
P	22 053/65	Targa	352		
P	22 060/70	Pergamena	306		
P	22 060/100	Pergamena	306		
P	22 064/70	Pergamena	306		
P	22 064/100	Pergamena	306		
P	22 075/70	Pergamena	306		
P	22 075/100	Pergamena	306		
P	22 086/70	Pergamena	306		
P	22 086/100	Pergamena	306		
P	22 097/70	Pergamena	306		
P	22 097/100	Pergamena	306		
P	22 109/70	Pergamena	306		
P	22 109/100	Pergamena	306		
P	22 111/70	Pergamena	306		
P	22 111/100	Pergamena	306		
P	22 120/75	Pergamena	307		
P	22 120/100	Pergamena	307		
P	22 122/70	Pergamena	306		
P	22 122/100	Pergamena	306		
P	22 133/70	Pergamena	306		
P	22 133/100	Pergamena	306		
P	22 144/70	Pergamena	306		
P	22 144/100	Pergamena	306		
P	22 150/75	Pergamena	307		
P	22 150/100	Pergamena	307		
T	22 221/70	Pergamena	305		
T	22 221/100	Pergamena	305		
T	22 221/110	Pergamena	305		
T	22 221/150	Pergamena	305		
T	22 221/180	Pergamena	305		
T	22 221/210	Pergamena	305		
T	22 221/250	Pergamena	305		
T	22 221/310	Pergamena	305		
P	22 233/70	Pergamena	306		
P	22 233/100	Pergamena	306		
P	22 235/75	Pergamena	307		
P	22 235/100	Pergamena	307		
P	22 240/140	Pergamena	305		
P	22 240/180	Pergamena	305		
P	22 244/70	Pergamena	306		
P	22 244/100	Pergamena	306		
P	22 280/75	Pergamena	307		
P	22 280/100	Pergamena	307		
P	22 350/75	Pergamena	307		

OGGETTISTICA ORNAMENTALE

	Codice Articolo	Descrizione	Pagina	Accessorio	
				Descrizione	Codice
P	22 350/100	Pergamena	307		
P	22 370/75	Pergamena	307		
P	22 370/100	Pergamena	307		
P	22 413/70	Pergamena	189		
P	22 413/100	Pergamena	189		
P	22 413/110	Pergamena	189		
P	22 413/150	Pergamena	189		
P	22 413/180	Pergamena	189		
P	22 415/70	Pergamena	161		
P	22 415/100	Pergamena	161		
P	22 415/110	Pergamena	161		
P	22 415/150	Pergamena	161		
P	22 415/180	Pergamena	161		
P	22 450/75	Pergamena	307		
P	22 450/100	Pergamena	307		
P	22 490/75	Pergamena	307		
P	22 490/100	Pergamena	307		
P	22 610/75	Pergamena	307		
P	22 610/100	Pergamena	307		
P	22 645/70	Pergamena	142		
P	22 645/100	Pergamena	142		
P	22 645/110	Pergamena	142		
P	22 650/75	Pergamena	307		
P	22 650/100	Pergamena	307		

23

P	23 000/40	Croce	351		
P	23 001/40	Croce	356		
P	23 002/40	Croce	356		
P	23 003/40	Croce	360		
P	23 004/40	Croce	360		
P	23 005/15	Croce	24,348		
P	23 005/20	Croce	24,348		
P	23 007/15	Croce	114		
P	23 007/20	Croce	114		
P	23 007/25	Croce	114		
P	23 010/15	Croce	25,348		
P	23 010/20	Croce	25,348		
P	23 017/15	Croce	348		
P	23 017/20	Croce	348		
P	23 017/25	Croce	348		
P	23 017/30	Croce	348		
P	23 017/40	Croce	348		
P	23 019/40	Croce	358		
P	23 023/15	Croce	184		
P	23 023/20	Croce	184		
P	23 023/25	Croce	184		
P	23 023/30	Croce	184		
P	23 024/15	Croce	113		
P	23 024/20	Croce	113		
P	23 024/25	Croce	113		
P	23 026/40	Croce	361		
P	23 028/15	Croce	116		
P	23 028/20	Croce	116		
P	23 028/25	Croce	116		
P	23 030/15	Croce	350		
P	23 030/20	Croce	350		
P	23 030/25	Croce	350		
P	23 030/30	Croce	350		
P	23 030/40	Croce	350		
P	23 031/20	Croce	355		
P	23 036/127	Croce	367		
P	23 040/35	Croce	349		
P	23 040/40	Croce	349		
P	23 041/20	Croce	355		
P	23 045/15	Croce	115		
P	23 045/20	Croce	115		

OGGETTISTICA ORNAMENTALE

Codice Articolo	Descrizione	Pagina	Accessorio	
			Descrizione	Codice
P 23 045/25	Croce	115		
P 23 046/15	Croce	162		
P 23 046/20	Croce	162		
P 23 046/25	Croce	162		
P 23 046/30	Croce	162		
P 23 048/15	Croce	112		
P 23 048/20	Croce	112		
P 23 048/25	Croce	112		
P 23 050/15	Croce	361		
P 23 050/20	Croce	361		
P 23 050/25	Croce	361		
P 23 054/38	Croce	358		
P 23 057/15	Croce	118		
P 23 057/20	Croce	118		
P 23 057/25	Croce	118		
P 23 065/15	Croce	117		
P 23 065/20	Croce	117		
P 23 065/25	Croce	117		
P 23 070/15	Croce	111		
P 23 070/20	Croce	111		
P 23 070/25	Croce	111		
P 23 081/15	Croce	119		
P 23 081/20	Croce	119		
P 23 081/25	Croce	119		
P 23 098/8	Croce	359		
P 23 098/10	Croce	359		
P 23 098/12	Croce	359		
P 23 098/15	Croce	359		
P 23 098/20	Croce	359		
P 23 098/25	Croce	359		
P 23 098/30	Croce	359		
P 23 117/20	Croce	350		
P 23 117/30	Croce	350		
P 23 117/40	Croce	350		
P 23 118/30	Croce	350		
P 23 118/40	Croce	350		
P 23 119/20	Croce	361		
P 23 119/30	Croce	361		
P 23 119/40	Croce	361		
P 23 134/17	Croce	359		
P 23 145/45	Croce	360		
P 23 147/45	Croce	356		
P 23 178/30	Croce	358		
P 23 200/25	Croce	46,354		
P 23 210/25	Croce	47,354		
P 23 236/70	Croce	358		
P 23 247/18	Croce	65,357		
P 23 250/34	Croce	359		
P 23 258/97	Croce	365		
P 23 269/15	Croce	357		
P 23 269/20	Croce	357		
P 23 269/30	Croce	357		
P 23 293/12	Croce	352		
P 23 293/15	Croce	352		
P 23 293/20	Croce	352		
P 23 293/25	Croce	352		
P 23 293/30	Croce	352		
P 23 293/35	Croce	352		
P 23 293/50	Croce	352		
P 23 293/65	Croce	352		
P 23 293/80	Croce	352		
P 23 295/12	Croce	184		
P 23 295/15	Croce	184		
P 23 295/20	Croce	184		
P 23 295/25	Croce	184		
P 23 295/30	Croce	184		
P 23 296/12	Croce	51,352		
P 23 296/15	Croce	51,352		

OGGETTISTICA ORNAMENTALE

Codice Articolo	Descrizione	Pagina	Accessorio	
			Descrizione	Codice
P 23 296/20	Croce	51,352		
P 23 297/12	Croce	153,162		
P 23 297/15	Croce	153,162		
P 23 297/20	Croce	153,162		
P 23 297/25	Croce	153,162		
P 23 297/30	Croce	153,162		
P 23 300/25	Croce	47,360		
T 23 305/70	Croce	366		
T 23 305/85	Croce	366		
P 23 311/15	Croce	357		
P 23 311/20	Croce	357		
P 23 316/15	Croce	52,357		
P 23 316/20	Croce	52,357		
P 23 316/28	Croce	52,357		
P 23 316/35	Croce	52,357		
P 23 316/50	Croce	52,357		
P 23 320/30	Croce	351		
P 23 320/40	Croce	351		
P 23 320/50	Croce	351		
T 23 327/55	Croce	367		
T 23 330/34	Croce	366		
T 23 330/44	Croce	366		
T 23 330/54	Croce	366		
P 23 338/20	Croce	350		
P 23 338/30	Croce	350		
P 23 338/40	Croce	350		
P 23 338/50	Croce	350		
P 23 340/40	Croce	363		
P 23 342/20	Croce	184		
P 23 342/30	Croce	184		
P 23 342/40	Croce	184		
P 23 344/15	Croce	162		
P 23 344/20	Croce	162		
P 23 344/25	Croce	162		
P 23 344/30	Croce	162		
P 23 349/15	Croce	361		
P 23 349/20	Croce	361		
P 23 349/25	Croce	361		
P 23 349/30	Croce	361		
P 23 349/35	Croce	361		
P 23 349/50	Croce	361		
P 23 351/15	Croce	356		
P 23 351/20	Croce	356		
P 23 351/25	Croce	356		
P 23 351/30	Croce	356		
P 23 351/40	Croce	356		
P 23 351/50	Croce	356		
P 23 351/60	Croce	356		
P 23 351/80	Croce	356		
P 23 351/100	Croce	356		
P 23 351/120	Croce	356		
P 23 373/15	Croce	361		
P 23 373/20	Croce	361		
P 23 373/25	Croce	361		
P 23 373/30	Croce	361		
P 23 373/35	Croce	361		
P 23 373/50	Croce	361		
P 23 395/16	Croce	361		
P 23 395/20	Croce	361		
P 23 395/25	Croce	361		
P 23 395/30	Croce	361		
P 23 395/40	Croce	361		
P 23 395/52	Croce	361		
P 23 418/30	Croce	360		
P 23 418/35	Croce	360		
P 23 431/15	Croce	361		
P 23 431/20	Croce	361		
P 23 431/25	Croce	361		

OGGETTISTICA ORNAMENTALE

Codice Articolo	Descrizione	Pagina	Accessorio	
			Descrizione	Codice
P 23 431/30	Croce	361		
P 23 431/40	Croce	361		
P 23 453/20	Croce	363		
P 23 453/25	Croce	363		
P 23 453/35	Croce	363		
P 23 453/50	Croce	363		
P 23 475/40	Croce	363		
P 23 475/50	Croce	363		
P 23 497/10	Croce	352		
P 23 533/16	Croce	349		
P 23 533/20	Croce	349		
P 23 533/25	Croce	349		
P 23 533/30	Croce	349		
P 23 533/40	Croce	349		
P 23 533/52	Croce	349		
P 23 577/40	Croce	363		
P 23 577/52	Croce	363		
P 23 599/25	Croce	363		
P 23 599/30	Croce	363		
P 23 599/40	Croce	363		
P 23 599/52	Croce	363		
P 23 613/40	Croce	363		
P 23 657/40	Croce	362		
P 23 715/40	Croce	362		
P 23 770/20	Croce	353		
P 23 772/40	Croce	363		
P 23 794/40	Croce	363		
P 23 817/40	Croce	363		
P 23 839/40	Croce	362		
P 23 852/40	Croce	362		
P 23 874/40	Croce	363		
P 23 896/40	Croce	362		
P 23 919/40	Croce	362		

24

P 24 060/40	Croce	360		
T 24 066/133	Croce	367		
P 24 113/40	Croce	362		
P 24 124/40	Croce	362		
P 24 146/40	Croce	362		
P 24 157/40	Croce	360		
P 24 160/15	Croce	69,349		
P 24 160/20	Croce	69,349		
P 24 160/25	Croce	69,349		
P 24 168/40	Croce	362		
P 24 185/15	Croce	70,349		
P 24 185/20	Croce	70,349		
P 24 185/25	Croce	70,349		
P 24 190/15	Croce	172,184		
P 24 190/20	Croce	172,184		
P 24 190/25	Croce	172,184		
P 24 215/15	Croce	351,563		
P 24 215/20	Croce	351		
P 24 215/25	Croce	351		
P 24 215/30	Croce	351		
P 24 215/40	Croce	351		
P 24 219/20	Croce	200		
P 24 219/25	Croce	200		
P 24 219/30	Croce	200		
P 24 219/40	Croce	200		
P 24 237/15	Croce	57,351		
P 24 237/20	Croce	57,351		
P 24 237/25	Croce	57,351		
P 24 237/30	Croce	57,351		
P 24 237/40	Croce	57,351		
P 24 239/15	Croce	146,162		
P 24 239/20	Croce	146,162		

OGGETTISTICA ORNAMENTALE

Codice Articolo	Descrizione	Pagina	Accessorio	
			Descrizione	Codice
P 24 239/25	Croce	146,162		
P 24 239/30	Croce	146,162		
P 24 256/15	Croce	134,139		
P 24 256/20	Croce	134,139		
P 24 256/25	Croce	134,139		
P 24 257/15	Croce	184		
P 24 257/20	Croce	184		
P 24 257/25	Croce	184		
P 24 257/30	Croce	184		
P 24 259/15	Croce	198		
P 24 259/20	Croce	198		
P 24 259/25	Croce	198		
P 24 259/30	Croce	198		
P 24 259/40	Croce	198		
P 24 268/15	Croce	162		
P 24 268/20	Croce	162		
P 24 268/25	Croce	162		
P 24 268/30	Croce	162		
P 24 268/40	Croce	162		
P 24 270/12	Croce	167,169		
P 24 270/15	Croce	167,169		
P 24 270/20	Croce	167,169		
P 24 272/50	Croce	365		
P 24 272/65	Croce	365		
P 24 272/75	Croce	365		
P 24 274/12	Croce	130,139		
P 24 274/15	Croce	130,139		
P 24 274/20	Croce	130,139		
P 24 275/15	Croce	132,139		
P 24 275/20	Croce	132,139		
P 24 281/50	Croce	364		
P 24 281/65	Croce	364		
P 24 281/75	Croce	364		
T 24 283/69	Croce	366		
T 24 283/80	Croce	366		
T 24 283/95	Croce	366		
P 24 294/50	Croce	364		
P 24 294/65	Croce	364		
P 24 294/75	Croce	364		
P 24 298/40	Croce	361		
P 24 298/50	Croce	361		
T 24 302/69	Croce	184		
T 24 306/69	Croce	366		
T 24 306/80	Croce	366		
T 24 306/95	Croce	366		
P 24 317/50	Croce	198		
P 24 320/40	Croce	353		
P 24 322/40	Croce	353		
P 24 324/40	Croce	353		
T 24 363/69	Croce	366		
T 24 363/95	Croce	366		
P 24 374/50	Croce	364		
P 24 374/65	Croce	364		
P 24 374/75	Croce	364		
T 24 385/69	Croce	366		
T 24 385/95	Croce	366		
P 24 396/50	Croce	364		
P 24 396/65	Croce	364		
P 24 396/75	Croce	364		
P 24 419/50	Croce	365		
P 24 419/65	Croce	365		
P 24 419/75	Croce	365		
P 24 419/70	Croce	366		
T 24 454/85	Croce	366		
P 24 500/15	Croce	32,348		
P 24 500/20	Croce	32,348		
P 24 500/25	Croce	32,348		
P 24 510/15	Croce	45,348		

OGGETTISTICA ORNAMENTALE

Codice Articolo	Descrizione	Pagina	Accessorio	
			Descrizione	Codice
P 24 510/20	Croce	45,348		
P 24 510/25	Croce	45,348		
P 24 807/15	Croce	198		
P 24 807/20	Croce	198		
P 24 807/25	Croce	198		
P 24 807/30	Croce	198		
P 24 807/35	Croce	198		
T 24 818/82	Croce	367		
T 24 818/105	Croce	367		
P 24 830/12	Croce	354		
P 24 830/20	Croce	354		
T 24 831/105	Croce	367		
P 24 840/20	Croce	354		
P 24 853/77	Croce	365		
P 24 853/97	Croce	365		
P 24 875/97	Croce	365		
P 24 897/17	Croce	64,360		

25

P 25 012/20	Angolare	344		
P 25 023/40	Angolare	344		
P 25 023/60	Angolare	344		
P 25 023/80	Angolare	344		
P 25 034/29	Angolare	344		
P 25 056/24	Angolare	344		
P 25 089/14	Angolare	344		
P 25 114/22	Angolare	344		
P 25 125/22	Angolare	344		
25 171/36	Crocefisso	521		
25 182/35	Crocefisso	521		
25 193/40	Crocefisso	520		
25 216/43	Crocefisso	520		
25 227/31	Crocefisso	520		
25 227/36	Crocefisso	520		
25 375/27	Candelabro	521		
25 386/24	Candelabro	521		
25 397/33	Candelabro	520		
25 411/24	Candelabro	520		
25 422/10	Candelabro	520		
25 422/16	Candelabro	520		
25 604/5	Borchia	519		
25 615/40	Colonnina	519		
25 615/60	Colonnina	519		

26

26 024/30	Borchia	529		
26 024/40	Borchia	529		
26 024/50	Borchia	529		
26 024/60	Borchia	529		
26 024/80	Borchia	529		
26 031/30	Borchia	188		
26 031/40	Borchia	188		
26 032/30	Borchia	164		
26 032/40	Borchia	164		
26 034/30	Borchia	529		
26 034/40	Borchia	529		
26 034/50	Borchia	529		
26 035/20	Borchia	529		
26 035/30	Borchia	529		
26 035/40	Borchia	529		
26 035/50	Borchia	529		
26 037/30	Borchia	143		
26 037/40	Borchia	143		
26 046/30	Borchia	529		
26 046/40	Borchia	529		
26 046/45	Borchia	529		

OGGETTISTICA ORNAMENTALE

Codice Articolo	Descrizione	Pagina	Accessorio	
			Descrizione	Codice
26 057/40	Borchia	529		
26 068/40	Borchia	530		
26 073/30	Borchia	188		
26 073/55	Borchia	188		
26 074/30	Borchia	529		
26 074/55	Borchia	529		
26 076/830	Borchia	164		
26 076/855	Borchia	164		
26 078/830	Borchia	143		
26 078/855	Borchia	143		
26 079/30	Borchia	529		
26 079/40	Borchia	529		
26 079/55	Borchia	529		
26 079/75	Borchia	529		
26 079/830	Borchia	529		
26 079/840	Borchia	529		
26 079/855	Borchia	529		
26 081/S	Borchia	530		
26 081/40	Borchia	529		
26 081/60	Borchia	529		
26 092/S	Borchia	530		
26 092/50	Borchia	529		
26 092/850	Borchia	529		
26 101/45	Borchia	188		
26 104/45	Borchia	529		
26 108/45	Borchia	143		
26 110/45	Borchia	164		
26 115/60	Borchia	529		
26 126/02	Borchia	529		
26 126/03	Borchia	529		
26 126/04	Borchia	529		
26 126/05	Borchia	529		
26 137/25	Pomolo	530		
26 148/S	Borchia	530		
26 148/25	Borchia	530		
26 159/35	Pomolo	530		
26 161/30	Borchia	524		
26 161/40	Borchia	524		
26 161/55	Borchia	524		
26 161/75	Borchia	524		
26 170/30	Borchia	143		
26 170/55	Borchia	143		
26 172/50	Borchia	530		
26 183/20	Borchia	529		
26 183/30	Borchia	529		
26 183/40	Borchia	529		
26 183/50	Borchia	529		
26 185/30	Borchia	164		
26 185/55	Borchia	164		
26 194/60	Borchia	530		
26 206/60	Borchia	530		
26 228/55	Borchia	530		
26 308/45	Borchia	199		
26 319/45	Borchia	203		
26 321/20	Borchia	199		
26 321/30	Borchia	199		
26 321/40	Borchia	199		
26 321/50	Borchia	199		
26 332/20	Borchia	203		
26 332/30	Borchia	203		
26 332/40	Borchia	203		
26 332/50	Borchia	203		
26 354/05	Chiavistello	531		
26 354/06	Chiavistello	531		
26 354/08	Chiavistello	531		
26 365/25	Chiavistello	531		
26 365/30	Chiavistello	531		
26 365/35	Chiavistello	531		

OGGETTISTICA ORNAMENTALE

Codice Articolo	Descrizione	Pagina	Accessorio	
			Descrizione	Codice
26 401/60	Staffa	530		
26 412/65	Staffa	530		
26 514/160	Anellone	531		
26 525/125	Anellone	531		
26 525/160	Anellone	531		
26 547/70	Anellone	531		
26 547/85	Anellone	531		
26 547/100	Anellone	531		
26 556/80	Anellone	199		
26 556/105	Anellone	199		
26 558/80	Anellone	531		
26 558/105	Anellone	531		
26 718/65	Anellone	531		
26 718/75	Anellone	531		

27

27 020/10	Staffa	527		
27 030/10	Staffa	527		
27 040/10	Staffa	527		
27 050/10	Staffa	527		
27 060/10	Staffa	527		
27 120/00	Staffa	527		
27 130/00	Staffa	527		
27 304/00	Staffa	526		
27 304/10	Staffa	526		
27 305/00	Staffa	524		
27 307/00	Staffa	188		
27 307/10	Staffa	188		
27 309/00	Staffa	524		
27 309/10	Staffa	524		
27 311/00	Staffa	524		
27 311/10	Staffa	524		
27 314/00	Staffa	526		
27 314/10	Staffa	526		
27 315/00	Staffa	524		
27 318/00	Staffa	188		
27 318/10	Staffa	188		
27 320/00	Staffa	143		
27 320/10	Staffa	143		
27 322/10	Staffa	524		
27 324/10	Staffa	526		
27 325/10	Staffa	188		
27 329/00	Staffa	143		
27 329/10	Staffa	143		
27 333/00	Staffa	526		
27 333/10	Staffa	526		
27 335/10	Staffa	143		
27 344/10	Staffa	526		
27 355/00	Staffa	526		
27 355/10	Staffa	526		
27 366/00	Staffa	528		
27 388/00	Staffa	528		
27 402/00	Staffa	528		
27 440/18	Staffa	528		
27 461/18	Staffa	528		
27 504/00	Staffa	199		
27 504/10	Staffa	199		
27 506/10	Staffa	203		
27 515/00	Staffa	199		
27 515/10	Staffa	199		
27 517/10	Staffa	203		
27 526/10	Staffa	199		
27 528/10	Staffa	203		

28

28 010/78	Lamp. Pensile	517	Fiamma Vetro	98 088
-----------	---------------	-----	--------------	--------

OGGETTISTICA ORNAMENTALE

Codice Articolo	Descrizione	Pagina	Accessorio	
			Descrizione	Codice
28 015/100	Catena	519		
28 026/100	Catena	519		
28 048/100	Catena	519		
28 059/100	Catena	519		
28 071/100	Catena	203		
28 100/72	Lamp. Pensile	517	Fiamma Vetro	98 066
28 106/22	Supporto	519		
28 106/34	Supporto	519		
28 120/100	Lamp. Pensile	518	Fiamma Vetro	98 088
28 152/20	Plafoniera	518	Cristallo Vetro	98 807 98 864
28 163/20	Plafoniera	518	Cristallo Vetro	98 831 98 864
28 221/60	Lamp. Pensile	515	Fiamma Vetro	98 055
28 231/90	Lamp. Pensile	516	Fiamma Vetro	98 088
28 254/63	Lamp. Pensile	515	Fiamma Vetro	98 066
28 254/97	Lamp. Pensile	515	Fiamma Vetro	98 066
28 265/63	Lamp. Pensile	515	Fiamma Vetro	98 066
28 287/90	Lamp. Pensile	515	Fiamma Vetro	98 088
28 298/90	Lamp. Pensile	516	Fiamma Vetro	98 088
28 334/100	Lamp. Pensile	516	Fiamma Vetro	98 088
28 367/108	Lamp. Pensile	517	Fiamma Vetro	98 088
28 378/90	Lamp. Pensile	516	Fiamma Vetro	98 088
28 378/124	Lamp. Pensile	516	Fiamma Vetro	98 088
28 410/100	Lamp. Pensile	513	Fiamma Vetro	98 060
28 412/100	Lamp. Pensile	513	Fiam. Goc. Oro ø 6	98 128
28 414/90	Lamp. Pensile	515	Fiamma Vetro	98 088
28 414/135	Lamp. Pensile	515	Fiamma Vetro	98 088
28 418/100	Lamp. Pensile	512	Fiam. Goc. Oro ø 6 Piatto	98 128 98 142
28 440/100	Lamp. Pensile	142	Fiamma Vetro	98 088
28 440/134	Lamp. Pensile	142	Fiamma Vetro	98 088
28 458/100	Lamp. Pensile	514	Fiamma Vetro	98 088
28 469/100	Lamp. Pensile	514	Fiamma Vetro	98 088
28 469/134	Lamp. Pensile	514	Fiamma Vetro	98 088
28 511/100	Lamp. Pensile	514	Fiamma Vetro	98 088
28 513/100	Lamp. Pensile	514	Fiamma Vetro	98 088
28 520/100	Lamp. Pensile	142	Fiamma Vetro	98 088
28 520/134	Lamp. Pensile	142	Fiamma Vetro	98 088
28 607/15	Supporto	519		
28 607/17	Supporto	519		

29

P 29 003/06	Oggettistica	463		
P 29 009/05	Oggettistica	463		
P 29 010/34	Motivi Floreali	424		
P 29 012/39	Motivi Floreali	424		
P 29 016/21	Motivi Floreali	418		
P 29 016/31	Motivi Floreali	418		
P 29 016/35	Motivi Floreali	418		
P 29 016/42	Motivi Floreali	418		
P 29 016/45	Motivi Floreali	418		
P 29 016/52	Motivi Floreali	418		
P 29 016/56	Motivi Floreali	418		
P 29 020/40	Motivi Floreali	429		
P 29 020/51	Motivi Floreali	428		
P 29 022/42	Motivi Floreali	429		
P 29 024/42	Motivi Floreali	429		
P 29 026/40	Motivi Floreali	427		
P 29 026/51	Motivi Floreali	426		
P 29 027/21	Motivi Floreali	418		
P 29 027/31	Motivi Floreali	418		
P 29 027/35	Motivi Floreali	418		
P 29 027/43	Motivi Floreali	418		
P 29 027/46	Motivi Floreali	418		
P 29 027/53	Motivi Floreali	418		
P 29 027/56	Motivi Floreali	418		

OGGETTISTICA ORNAMENTALE

OGGETTISTICA ORNAMENTALE

Codice Articolo	Descrizione	Pagina	Accessorio	
			Descrizione	Codice
P 29 029/40	Motivi Floreali	429		
P 29 029/51	Motivi Floreali	428		
P 29 030/40	Motivi Floreali	427		
P 29 030/51	Motivi Floreali	426		
P 29 033/27	Motivi Floreali	429		
P 29 035/27	Motivi Floreali	429		
P 29 037/07	Motivi Floreali	403		
P 29 038/21	Motivi Floreali	419		
P 29 038/32	Motivi Floreali	419		
P 29 038/36	Motivi Floreali	419		
P 29 038/43	Motivi Floreali	419		
P 29 038/48	Motivi Floreali	419		
P 29 038/60	Motivi Floreali	419		
P 29 040/08	Motivi Floreali	431		
P 29 044/30	Motivi Floreali	427		
P 29 044/40	Motivi Floreali	427		
P 29 045/16	Motivi Floreali	431		
P 29 046/04	Oggettistica	463		
P 29 049/50	Motivi Floreali	419		
P 29 051/50	Motivi Floreali	419		
P 29 055/42	Motivi Floreali	427		
P 29 056/42	Motivi Floreali	427		
P 29 057/27	Motivi Floreali	427		
P 29 058/27	Motivi Floreali	427		
P 29 059/46	Motivi Floreali	430		
P 29 060/17	Motivi Floreali	402		
P 29 061/34	Motivi Floreali	430		
P 29 062/44	Motivi Floreali	422		
P 29 066/04	Oggettistica	463		
P 29 068/42	Motivi Floreali	430		
P 29 069/04	Motivi Floreali	403		
P 29 071/04	Oggettistica	463		
P 29 073/44	Motivi Floreali	422		
P 29 078/16	Motivi Floreali	431		
P 29 079/19	Motivi Floreali	402		
P 29 080/34	Motivi Floreali	402		
P 29 081/40	Motivi Floreali	430		
P 29 083/10	Motivi Floreali	429		
P 29 084/28	Motivi Floreali	422		
P 29 084/39	Motivi Floreali	422		
P 29 084/43	Motivi Floreali	422		
P 29 084/48	Motivi Floreali	422		
P 29 090/32	Motivi Floreali	431		
P 29 092/10	Motivi Floreali	427		
P 29 093/54	Motivi Floreali	404		
P 29 094/26	Motivi Floreali	431		
T 29 097/06	Oggettistica	463		
P 29 098/04	Motivi Floreali	403		
T 29 099/09	Oggettistica	463		
P 29 100/19	Motivi Floreali	402		
P 29 101/25	Motivi Floreali	431		
T 29 102/08	Oggettistica	463		
T 29 103/54	Motivi Floreali	404		
T 29 104/05	Oggettistica	463		
P 29 105/06	Motivi Floreali	403		
P 29 106/15	Motivi Floreali	402		
P 29 108/25	Motivi Floreali	431		
P 29 109/12	Motivi Floreali	404		
P 29 110/38	Motivi Floreali	423		
P 29 112/35	Motivi Floreali	423		
P 29 115/85	Motivi Floreali	430		
P 29 116/06	Motivi Floreali	403		
P 29 117/10	Motivi Floreali	402		
P 29 118/15	Motivi Floreali	404		
P 29 119/17	Motivi Floreali	402		
P 29 120/34	Motivi Floreali	402		
P 29 121/08	Motivi Floreali	403		
P 29 122/50	Motivi Floreali	430		

Codice Articolo	Descrizione	Pagina	Accessorio	
			Descrizione	Codice
P 29 124/14	Motivi Floreali	424		
P 29 128/17	Motivi Floreali	431		
P 29 130/19	Motivi Floreali	402		
P 29 132/14	Motivi Floreali	424		
P 29 134/14	Motivi Floreali	410		
P 29 134/18	Motivi Floreali	410		
P 29 134/22	Motivi Floreali	410		
P 29 134/27	Motivi Floreali	410		
P 29 134/30	Motivi Floreali	410		
P 29 134/39	Motivi Floreali	410		
P 29 134/44	Motivi Floreali	410		
P 29 138/14	Motivi Floreali	412		
P 29 138/18	Motivi Floreali	412		
P 29 138/22	Motivi Floreali	412		
P 29 138/27	Motivi Floreali	412		
P 29 138/30	Motivi Floreali	412		
P 29 138/39	Motivi Floreali	412		
P 29 138/44	Motivi Floreali	412		
P 29 140/30	Motivi Floreali	405		
P 29 140/40	Motivi Floreali	405		
P 29 142/08	Motivi Floreali	403		
P 29 144/22	Motivi Floreali	425		
P 29 146/08	Motivi Floreali	403		
P 29 150/30	Motivi Floreali	405		
P 29 150/40	Motivi Floreali	405		
P 29 180/08	Motivi Floreali	403		
P 29 195/52	Motivi Floreali	391		
P 29 200/52	Motivi Floreali	389		
P 29 205/35	Motivi Floreali	390		
P 29 206/50	Motivi Floreali	392		
P 29 209/32	Motivi Floreali	393		
P 29 210/52	Motivi Floreali	388		
P 29 211/25	Motivi Floreali	423		
P 29 220/30	Motivi Floreali	405		
P 29 220/40	Motivi Floreali	405		
P 29 229/30	Motivi Floreali	405		
P 29 229/40	Motivi Floreali	405		
P 29 233/47	Motivi Floreali	423		
P 29 235/30	Motivi Floreali	405		
P 29 235/40	Motivi Floreali	405		
P 29 239/30	Motivi Floreali	405		
P 29 239/40	Motivi Floreali	405		
P 29 259/13	Motivi Floreali	424		
P 29 260/13	Motivi Floreali	424		
P 29 270/18	Motivi Floreali	424		
P 29 280/18	Motivi Floreali	424		
P 29 290/16	Motivi Floreali	424		
P 29 300/52	Motivi Floreali	388		
P 29 301/45	Motivi Floreali	421		
P 29 304/52	Motivi Floreali	388		
P 29 305/14	Motivi Floreali	411		
P 29 305/18	Motivi Floreali	411		
P 29 305/22	Motivi Floreali	411		
P 29 305/27	Motivi Floreali	411		
P 29 305/30	Motivi Floreali	411		
P 29 305/39	Motivi Floreali	411		
P 29 305/44	Motivi Floreali	411		
P 29 307/52	Motivi Floreali	389		
P 29 309/52	Motivi Floreali	389		
P 29 310/14	Motivi Floreali	408		
P 29 310/18	Motivi Floreali	408		
P 29 310/22	Motivi Floreali	408		
P 29 310/27	Motivi Floreali	408		
P 29 310/30	Motivi Floreali	408		
P 29 310/39	Motivi Floreali	408		
P 29 310/44	Motivi Floreali	408		
P 29 312/45	Motivi Floreali	421		
P 29 314/35	Motivi Floreali	390		

OGGETTISTICA ORNAMENTALE

	Codice Articolo	Descrizione	Pagina	Accessorio	
				Descrizione	Codice
P	29 315/14	Motivi Floreali	409		
P	29 315/18	Motivi Floreali	409		
P	29 315/22	Motivi Floreali	409		
P	29 315/27	Motivi Floreali	409		
P	29 315/30	Motivi Floreali	409		
P	29 315/39	Motivi Floreali	409		
P	29 315/44	Motivi Floreali	409		
P	29 318/35	Motivi Floreali	390		
P	29 320/50	Motivi Floreali	392		
P	29 321/14	Motivi Floreali	413		
P	29 321/18	Motivi Floreali	413		
P	29 321/22	Motivi Floreali	413		
P	29 321/27	Motivi Floreali	413		
P	29 321/30	Motivi Floreali	413		
P	29 321/39	Motivi Floreali	413		
P	29 321/44	Motivi Floreali	413		
P	29 327/50	Motivi Floreali	392		
P	29 323/28	Motivi Floreali	421		
P	29 334/32	Motivi Floreali	393		
P	29 335/28	Motivi Floreali	421		
P	29 337/32	Motivi Floreali	393		
P	29 346/15	Motivi Floreali	421		
P	29 346/19	Motivi Floreali	421		
P	29 346/23	Motivi Floreali	421		
P	29 346/28	Motivi Floreali	421		
P	29 346/31	Motivi Floreali	421		
P	29 346/40	Motivi Floreali	421		
P	29 346/45	Motivi Floreali	421		
P	29 350/16	Motivi Floreali	424		
P	29 351/14	Motivi Floreali	420		
P	29 351/18	Motivi Floreali	420		
P	29 351/22	Motivi Floreali	420		
P	29 351/27	Motivi Floreali	420		
P	29 351/30	Motivi Floreali	420		
P	29 351/39	Motivi Floreali	420		
P	29 351/44	Motivi Floreali	420		
P	29 369/14	Motivi Floreali	420		
P	29 369/18	Motivi Floreali	420		
P	29 369/22	Motivi Floreali	420		
P	29 369/27	Motivi Floreali	420		
P	29 369/30	Motivi Floreali	420		
P	29 369/39	Motivi Floreali	420		
P	29 369/44	Motivi Floreali	420		
P	29 404/23	Motivi Floreali	425		
P	29 415/20	Motivi Floreali	425		
P	29 448/21	Motivi Floreali	425		
P	29 459/25	Motivi Floreali	424		
P	29 472/22	Motivi Floreali	424		
P	29 483/16	Motivi Floreali	425		
P	29 506/25	Motivi Floreali	425		
P	29 517/26	Motivi Floreali	425		
P	29 528/26	Motivi Floreali	425		
P	29 539/24	Motivi Floreali	424		
P	29 541/21	Motivi Floreali	425		
P	29 552/29	Motivi Floreali	425		
P	29 561/29	Motivi Floreali	425		
P	29 563/16	Motivi Floreali	425,563		
P	29 574/27	Motivi Floreali	425		
P	29 585/22	Motivi Floreali	425		
P	29 596/23	Motivi Floreali	424		
P	29 619/21	Motivi Floreali	415		
P	29 619/32	Motivi Floreali	415		
P	29 619/36	Motivi Floreali	415		
P	29 619/43	Motivi Floreali	415		
P	29 619/48	Motivi Floreali	415		
P	29 619/60	Motivi Floreali	415		
P	29 621/21	Motivi Floreali	414		
P	29 621/31	Motivi Floreali	414		

OGGETTISTICA ORNAMENTALE

	Codice Articolo	Descrizione	Pagina	Accessorio	
				Descrizione	Codice
P	29 621/35	Motivi Floreali	414		
P	29 621/43	Motivi Floreali	414		
P	29 621/46	Motivi Floreali	414		
P	29 621/53	Motivi Floreali	414		
P	29 621/56	Motivi Floreali	414		
P	29 632/21	Motivi Floreali	414		
P	29 632/31	Motivi Floreali	414		
P	29 632/35	Motivi Floreali	414		
P	29 632/42	Motivi Floreali	414		
P	29 632/45	Motivi Floreali	414		
P	29 632/52	Motivi Floreali	414		
P	29 632/56	Motivi Floreali	414		
P	29 634/50	Motivi Floreali	415		
P	29 636/50	Motivi Floreali	415		
P	29 654/21	Motivi Floreali	417		
P	29 654/32	Motivi Floreali	417		
P	29 654/36	Motivi Floreali	417		
P	29 654/43	Motivi Floreali	417		
P	29 654/48	Motivi Floreali	417		
P	29 654/60	Motivi Floreali	417		
P	29 655/21	Motivi Floreali	416		
P	29 665/31	Motivi Floreali	416		
P	29 665/35	Motivi Floreali	416		
P	29 665/43	Motivi Floreali	416		
P	29 665/46	Motivi Floreali	416		
P	29 665/53	Motivi Floreali	416		
P	29 665/56	Motivi Floreali	416		
P	29 676/21	Motivi Floreali	416		
P	29 676/31	Motivi Floreali	416		
P	29 676/35	Motivi Floreali	416		
P	29 676/42	Motivi Floreali	416		
P	29 676/45	Motivi Floreali	416		
P	29 676/52	Motivi Floreali	416		
P	29 676/56	Motivi Floreali	416		
P	29 678/50	Motivi Floreali	417		
P	29 680/50	Motivi Floreali	417		
T	29 681/53	Motivi Floreali	394		
T	29 683/53	Motivi Floreali	394		
T	29 685/53	Motivi Floreali	394		
T	29 688/53	Motivi Floreali	394		
T	29 690/51	Motivi Floreali	395		
T	29 693/51	Motivi Floreali	395		
T	29 695/51	Motivi Floreali	395		
T	29 698/51	Motivi Floreali	395		
P	29 715/25	Motivi Floreali	397		
P	29 720/25	Motivi Floreali	397		
P	29 750/30	Motivi Floreali	399		
P	29 751/28	Motivi Floreali	396		
P	29 752/30	Motivi Floreali	399		
P	29 753/28	Motivi Floreali	396		
P	29 754/30	Motivi Floreali	399		
P	29 755/28	Motivi Floreali	396		
P	29 756/30	Motivi Floreali	399		
P	29 757/28	Motivi Floreali	396		
P	29 758/30	Motivi Floreali	399		
P	29 760/15	Motivi Floreali	400		
P	29 762/15	Motivi Floreali	400		
P	29 764/15	Motivi Floreali	400		
P	29 766/15	Motivi Floreali	400		
P	29 780/16	Motivi Floreali	398		
P	29 782/16	Motivi Floreali	398		
P	29 784/16	Motivi Floreali	398		
P	29 786/16	Motivi Floreali	398		
P	29 811/28	Motivi Floreali	397		
P	29 818/28	Motivi Floreali	397		
P	29 830/16	Motivi Floreali	398		
P	29 832/16	Motivi Floreali	398		
P	29 834/16	Motivi Floreali	398		

OGGETTISTICA ORNAMENTALE

P	Codice Articolo	Descrizione	Pagina	Accessorio	
				Descrizione	Codice
P	29 836/16	Motivi Floreali	398		
P	29 850/15	Motivi Floreali	399		
P	29 852/15	Motivi Floreali	399		
P	29 854/15	Motivi Floreali	399		
P	29 856/15	Motivi Floreali	399		

30

P	30 000/16	Crocefisso	372		
P	30 000/24	Crocefisso	372		
P	30 000/27	Crocefisso	372		
P	30 000/30	Crocefisso	372		
P	30 000/60	Crocefisso	372		
P	30 001/11	Crocefisso	372		
P	30 001/21	Crocefisso	372		
P	30 001/28	Crocefisso	372		
P	30 001/36	Crocefisso	372		
P	30 001/50	Crocefisso	372		
P	30 018/10	Crocefisso	372		
P	30 018/15	Crocefisso	372		
P	30 018/20	Crocefisso	372		
P	30 018/25	Crocefisso	372		
P	30 020/25	Crocefisso	368		
P	30 020/58	Crocefisso	368		
P	30 035/25	Crocefisso	45,368		
P	30 053/09	Crocefisso	373		
P	30 053/13	Crocefisso	373		
P	30 053/17	Crocefisso	373		
P	30 053/26	Crocefisso	373		
P	30 053/37	Crocefisso	373		
P	30 053/50	Crocefisso	373		
P	30 053/65	Crocefisso	373		
P	30 053/80	Crocefisso	373		
P	30 058/13	Crocefisso	185		
P	30 058/17	Crocefisso	185		
P	30 058/26	Crocefisso	185		
P	30 058/37	Crocefisso	185		
P	30 060/13	Crocefisso	162		
P	30 060/17	Crocefisso	162		
P	30 060/26	Crocefisso	162		
P	30 060/37	Crocefisso	162		
P	30 064/90	Crocefisso	370		
P	30 075/120	Crocefisso	371		
P	30 080/134	Crocefisso	369		
P	30 086/09	Crocefisso	200		
P	30 086/13	Crocefisso	200		
P	30 086/17	Crocefisso	200		
P	30 086/26	Crocefisso	200		
P	30 086/37	Crocefisso	200		
P	30 140/83	Crocefisso	370		

31

P	31 001/38	Targa	461		
P	31 003/21	Targa	461		
P	31 005/14	Targa	461		
P	31 013/14	Targa	161		
P	31 014/16	Targa	450		
P	31 014/20	Targa	450		
P	31 014/30	Targa	450		
P	31 017/16	Targa	445		
P	31 017/20	Targa	445		
P	31 017/31	Targa	445		
P	31 019/12	Targa	443		
P	31 019/17	Targa	443		
P	31 019/24	Targa	443		
P	31 021/12	Targa	448		
P	31 021/17	Targa	448		

OGGETTISTICA ORNAMENTALE

P	Codice Articolo	Descrizione	Pagina	Accessorio	
				Descrizione	Codice
P	31 021/25	Targa	448		
P	31 025/34	Targa	450		
P	31 028/34	Targa	445		
P	31 030/14	Targa	449		
P	31 030/16	Targa	449		
P	31 030/20	Targa	449		
P	31 032/14	Targa	448		
P	31 032/20	Targa	448		
P	31 035/14	Targa	185		
P	31 035/20	Targa	185		
P	31 039/14	Targa	161		
P	31 039/20	Targa	161		
P	31 040/17	Targa	460		
P	31 041/14	Targa	445		
P	31 041/16	Targa	445		
P	31 041/20	Targa	445		
P	31 043/14	Targa	443		
P	31 043/20	Targa	443		
P	31 045/13	Targa	139		
P	31 045/18	Targa	139		
P	31 046/13	Targa	139		
P	31 046/18	Targa	139		
P	31 047/18	Targa	139		
P	31 047/26	Targa	139		
P	31 050/17	Targa	460		
P	31 052/14	Targa	453		
P	31 052/16	Targa	453		
P	31 052/21	Targa	453		
P	31 065/23	Targa	445		
P	31 075/10	Targa	442		
P	31 075/18	Targa	442		
P	31 075/28	Targa	442		
P	31 076/18	Targa	442		
P	31 082/06	Oggettistica	465		
P	31 083/08	Oggettistica	465		
P	31 085/13	Targhetta	425		
P	31 087/07	Oggettistica	465		
P	31 090/03	Oggettistica	465		
P	31 090/04	Oggettistica	465		
P	31 098/23	Targa	445		
P	31 101/18	Targa	453		
P	31 101/26	Targa	453		
P	31 103/18	Targa	201		
P	31 103/26	Targa	201		
P	31 106/18	Targa	185		
P	31 106/26	Targa	185		
P	31 108/18	Targa	161		
P	31 108/26	Targa	161		
P	31 112/12	Targa	451		
P	31 112/27	Targa	451		
P	31 115/16	Targa	445		
P	31 115/20	Targa	445		
P	31 115/31	Targa	445		
P	31 123/20	Targa	449		
P	31 126/34	Targa	445		
P	31 156/26	Targa	447		
P	31 160/33	Targa	444		
P	31 167/26	Targa	451		
P	31 178/15	Targa	443		
P	31 180/10	Targa	448		
P	31 180/18	Targa	448		
P	31 180/28	Targa	448		
P	31 189/15	Targa	451		
P	31 190/10	Targa	453		
P	31 190/18	Targa	453		
P	31 190/30	Targa	453		
P	31 191/14	Targa	442		
P	31 191/20	Targa	442		

OGGETTISTICA ORNAMENTALE

	Codice Articolo	Descrizione	Pagina	Accessorio	
				Descrizione	Codice
P	31 203/14	Targa	449		
P	31 203/20	Targa	449		
P	31 210/29	Targa	451		
P	31 223/30	Targa	461		
P	31 225/20	Targa	448		
P	31 236/26	Targa	449		
P	31 247/18	Targa	442		
P	31 247/30	Targa	442		
P	31 258/27	Targa	448		
T	31 260/10	Oggettistica	464		
P	31 282/49	Targa	453		
P	31 293/49	Targa	447		
P	31 305/44	Targa	446		
P	31 320/47	Targa	450		
P	31 327/50	Targa	453		
P	31 338/50	Targa	447		
P	31 349/41	Targa	453		
P	31 362/24	Targa	445		
P	31 373/37	Targa	446		
P	31 384/26	Targa	452		
P	31 395/46	Targa	452		
P	31 407/32	Targa	452		
P	31 418/40	Targa	446		
P	31 418/50	Targa	446		
P	31 429/40	Targa	446		
P	31 464/39	Targa	452		
P	31 475/40	Targa	452		
P	31 490/37	Targa	449		
P	31 504/50	Targa	455		
P	31 511/40	Targa	450		
P	31 522/52	Targa	452		
P	31 533/19	Targa	454		
P	31 533/26	Targa	454		
P	31 536/19	Targa	185		
P	31 536/26	Targa	185		
P	31 570/50	Targa	450		
P	31 645/13	Targa	460		
P	31 646/20	Targa	460		
P	31 646/25	Targa	460		
P	31 648/21	Targa	185		
P	31 648/25	Targa	185		
P	31 650/13	Targa	460		
P	31 655/29	Targa	455		
P	31 657/20	Targa	460		
P	31 657/25	Targa	460		
P	31 659/21	Targa	185		
P	31 659/25	Targa	185		
P	31 661/13	Targa	51,443		
P	31 661/18	Targa	51,443		
P	31 664/13	Targa	185		
P	31 664/18	Targa	185		
P	31 664/26	Targa	185		
P	31 666/13	Targa	201		
P	31 666/18	Targa	201		
P	31 668/13	Targa	443		
P	31 668/18	Targa	443		
P	31 668/26	Targa	443		
P	31 670/13	Targa	161		
P	31 670/18	Targa	161		
P	31 670/26	Targa	161		
P	31 672/13	Targa	51,448		
P	31 672/18	Targa	51,448		
P	31 675/13	Targa	185		
P	31 675/18	Targa	185		
P	31 675/26	Targa	185		
P	31 677/13	Targa	201		
P	31 677/18	Targa	201		
P	31 679/13	Targa	448		

OGGETTISTICA ORNAMENTALE

	Codice Articolo	Descrizione	Pagina	Accessorio	
				Descrizione	Codice
P	31 679/18	Targa	448		
P	31 679/26	Targa	448		
P	31 680/36	Targa	455		
P	31 681/14	Targa	453		
P	31 681/18	Targa	453		
P	31 681/26	Targa	453		
P	31 688/14	Targa	51,453		
P	31 688/18	Targa	51,453		
P	31 690/13	Targa	161		
P	31 690/18	Targa	161		
P	31 690/26	Targa	161		
P	31 790/49	Targa	455		
P	31 828/20	Targa	459		
P	31 830/23	Targa	444		
P	31 839/20	Targa	459		

32

P	32 001/05	Targa	460		
P	32 001/10	Targa	460		
P	32 010/09	Targa	446		
P	32 010/13	Targa	446		
P	32 010/26	Targa	446		
P	32 010/47	Targa	446		
T	32 035/27	Oggettistica	464		
P	32 044/24	Targa	448		
P	32 055/30	Targa	449		
P	32 077/29	Targa	445		
P	32 099/54	Targa	451		
P	32 100/30	Targa	461		
P	32 102/41	Targa	447		
P	32 107/42	Targa	453		
P	32 128/38	Targa	453		
P	32 131/43	Targa	453		
P	32 173/29	Targa	461		
P	32 180/45	Targa	455		
P	32 185/26	Targa	453		
P	32 215/38	Targa	461		
P	32 226/20	Targa	461		
P	32 226/37	Targa	461		
P	32 250/52	Targa	452		
P	32 283/42	Targa	452		
P	32 317/40	Targa	454		
P	32 317/56	Targa	454		
P	32 328/60	Targa	455		
P	32 419/20	Targa	457		
P	32 421/31	Targa	458		
P	32 470/35	Targa	459		
P	32 540/34	Targa	457		
P	32 541/24	Targa	461		
P	32 558/08	Cuore	305		
P	32 558/09	Cuore	305		
P	32 558/10	Cuore	305		
P	32 567/15	Cuori Allacciati	305		
P	32 576/105	Targa	201		
P	32 578/105	Targa	448,563		
P	32 587/106	Targa	201		
P	32 589/106	Targa	443		
P	32 592/53	Targa	458		
T	32 594/66	Targa	458		
P	32 603/21	Targa	458		
P	32 603/31	Targa	458		
P	32 630/26	Oggettistica	464		
P	32 630/37	Oggettistica	464		
P	32 669/10	Targa	449		
P	32 671/10	Targa	442		
P	32 674/14	Targa	442		
P	32 674/20	Targa	442		

OGGETTISTICA ORNAMENTALE

Codice Articolo	Descrizione	Pagina	Accessorio	
			Descrizione	Codice
P 32 682/18	Targa	446		
P 32 685/18	Targa	185		
P 32 693/20	Targa	445		
P 32 696/20	Targa	185		
P 32 716/35	Targa	446		
P 32 730/12	Targa	461		
P 32 738/22	Targa	446		
P 32 738/32	Targa	446		
P 32 773/35	Targa	444		
P 32 795/35	Targa	450		
P 32 818/20	Targa	445		
P 32 818/30	Targa	445		
P 32 829/20	Targa	450		
P 32 829/30	Targa	450		
P 32 831/36	Targa	452		
P 32 831/46	Targa	452		
P 32 831/53	Targa	452		
P 32 875/35	Targa	444		
P 32 886/35	Targa	450		
P 32 897/38	Targa	452		
P 32 897/49	Targa	452		
P 32 897/57	Targa	452		
P 32 911/39	Targa	450		
P 32 922/34	Targa	450		
P 32 933/39	Targa	444		
P 32 944/34	Targa	444		
P 32 955/55	Targa	452		
P 32 961/17	Targa	185		
P 32 963/17	Targa	185		
P 32 977/40	Targa	449		
P 32 988/42	Targa	444		
P 32 990/42	Targa	454		
P 32 995/51	Targa	452		

33

P 33 001/10	Cuore	305		
P 33 003/10	Cuore	305		
P 33 012/56	Targa	447		
P 33 023/28	Targa	449		
P 33 025/107	Targa	457		
P 33 027/20	Targa	461		
P 33 027/59	Targa	461		
P 33 045/35	Targa	451		
P 33 045/43	Targa	451		
T 33 080/44	Busto	508		
T 33 120/37	Busto	508		
P 33 136/48	Targa	458		
P 33 147/38	Targa	451		
P 33 171/93	Targa	455		
P 33 178/104	Targa	456		
P 33 200/08	Oggettistica	464		
P 33 200/11	Oggettistica	464		
P 33 200/15	Oggettistica	464		
P 33 200/20	Oggettistica	464		
P 33 200/30	Oggettistica	464		
P 33 200/50	Oggettistica	464		
P 33 210/12	Oggettistica	465		
P 33 210/20	Oggettistica	465		
P 33 210/30	Oggettistica	465		
P 33 210/45	Oggettistica	465		
P 33 231/60	Targa	455		
P 33 250/12	Oggettistica	464		
P 33 250/21	Oggettistica	464		
P 33 250/27	Oggettistica	464		
P 33 250/40	Oggettistica	464		
P 33 250/50	Oggettistica	464		
P 33 260/17	Oggettistica	464		

OGGETTISTICA ORNAMENTALE

Codice Articolo	Descrizione	Pagina	Accessorio	
			Descrizione	Codice
T 33 265/15	Oggettistica	464		
T 33 273/40	Busto	508		
T 33 284/43	Busto	508		
P 33 290/20	Oggettistica	465		
T 33 295/40	Busto	508		
T 33 307/35	Busto	508		
P 33 310/18	Oggettistica	464		
P 33 320/11	Oggettistica	464		
P 33 340/08	Oggettistica	465		
P 33 360/11	Oggettistica	465		
T 33 386/44	Oggettistica	462		
T 33 401/0	Oggettistica	463		
T 33 402/0	Oggettistica	463		
T 33 403/0	Oggettistica	463		
T 33 404/0	Oggettistica	463		
T 33 410/0	Oggettistica	463		
T 33 412/0	Oggettistica	463		
T 33 415/0	Oggettistica	463		
T 33 444/102	Oggettistica	462		
T 33 502/8	Oggettistica	462		
T 33 524/16	Oggettistica	462		
T 33 546/12	Oggettistica	462		
T 33 568/23	Oggettistica	462		
T 33 581/30	Oggettistica	462		
T 33 604/34	Oggettistica	462		
P 33 615/34	Targa	459		
T 33 934/0	Oggettistica	462		

34

T 34 010/36	Urna Cineraria	555		
T 34 020/39	Urna Cineraria	557		
T 34 030/28	Urna Cineraria	554		
T 34 040/39	Urna Cineraria	556		
P 34 200/37	Mosaico	439		
P 34 220/53	Mosaico	437		
P 34 230/51	Mosaico	433		
P 34 240/52	Mosaico	438		
P 34 250/52	Mosaico	438		
P 34 270/41	Mosaico	439		
P 34 290/46	Mosaico	434		
P 34 300/48	Mosaico	437		
P 34 310/45	Mosaico	434		
P 34 320/45	Mosaico	436		
P 34 330/45	Mosaico	435		
P 34 340/45	Mosaico	436		
P 34 350/45	Mosaico	435		

35

T 35 001/38	Statua	502		
T 35 003/60	Statua	468		
P 35 014/40	Statua	470		
T 35 025/38	Statua	470		
T 35 030/25	Statua	496		
T 35 047/39	Statua	482		
T 35 050/45	Statua	480		
P 35 058/38	Statua	468		
T 35 069/37	Statua	468		
T 35 082/26	Statua	468		
T 35 082/38	Statua	468		
T 35 093/43	Statua	480		
T 35 110/41	Statua	476		
T 35 116/44	Statua	488		
T 35 149/43	Statua	476		
P 35 151/41	Statua	472		
T 35 162/40	Statua	472		
T 35 162/63	Statua	472		

OGGETTISTICA ORNAMENTALE

	Codice Articolo	Descrizione	Pagina	Accessorio	
				Descrizione	Codice
P	35 173/41	Statua	468		
T	35 184/40	Statua	468		
T	35 184/63	Statua	468		
T	35 207/40	Statua	482		
T	35 207/63	Statua	482		
T	35 208/06	Angioletto	498		
T	35 210/11	Angioletto	498		
T	35 212/05	Angioletto	499		
T	35 214/06	Angioletto	498		
T	35 215/60	Statua	471		
T	35 215/78	Statua	471		
T	35 217/11	Angioletto	498		
T	35 218/44	Statua	496		
T	35 220/11	Angioletto	498		
T	35 223/74	Statua	471		
T	35 223/96	Statua	471		
T	35 226/11	Angioletto	498		
T	35 228/06	Angioletto	498		
T	35 245/06	Angioletto	498		
T	35 250/60	Statua	469		
T	35 251/05	Angioletto	499		
T	35 260/05	Angioletto	499		
T	35 264/61	Statua	468		
T	35 267/05	Angioletto	499		
T	35 270/43	Statua	472		
T	35 300/65	Statua	472		
T	35 350/35	Statua	502		
P	35 355/19	Statua	454		
P	35 355/26	Statua	454		
T	35 360/63	Statua	502		
T	35 366/19	Statua	454		
T	35 366/26	Statua	454		
T	35 420/45	Statua	488		
T	35 446/65	Statua	468		
P	35 524/28	Statua	482		
T	35 526/26	Statua	482		
T	35 526/41	Statua	482		
T	35 526/54	Statua	483		
T	35 526/80	Statua	483		
P	35 546/28	Statua	470		
T	35 548/26	Statua	470		
T	35 548/41	Statua	470		
T	35 548/54	Statua	470		
T	35 548/80	Statua	470		
T	35 561/55	Statua	494		
T	35 561/80	Statua	494		
P	35 581/28	Statua	471		
T	35 583/26	Statua	471		
T	35 583/41	Statua	471		
T	35 583/54	Statua	471		
T	35 583/80	Statua	471		
T	35 606/63	Statua	479		
T	35 674/55	Statua	488		
T	35 719/26	Statua	496		

36

T	36 170/62	Statua	504		
T	36 170/94	Statua	504		
T	36 605/62	Statua	502		
T	36 879/42	Statua	494		
T	36 879/55	Statua	494		
T	36 879/71	Statua	494		
T	36 881/44	Statua	484		
T	36 881/61	Statua	484		
T	36 892/76	Statua	491		
T	36 904/100	Statua	481		
T	36 904/131	Statua	481		

OGGETTISTICA ORNAMENTALE

	Codice Articolo	Descrizione	Pagina	Accessorio	
				Descrizione	Codice
T	36 906/104	Statua	478		
T	36 915/55	Statua	475		
T	36 915/124	Statua	475		
T	36 926/65	Statua	469		
T	36 948/63	Statua	482		
T	36 961/60	Statua	483		
T	36 972/53	Statua	504		
T	36 983/60	Statua	470		

37

T	37 007/80	Statua	472		
T	37 048/30	Statua	507		
T	37 050/60	Statua	507		
T	37 050/200	Statua	507		
T	37 061/80	Statua	479		
T	37 064/57	Statua	501		
T	37 064/100	Statua	501		
T	37 064/180	Statua	501		
T	37 068/45	Statua	478		
T	37 072/30	Statua	497		
T	37 072/53	Statua	472		
T	37 107/98	Statua	506		
T	37 109/92	Statua	494		
T	37 110/100	Statua	502		
T	37 115/174	Statua	503		
T	37 117/87	Statua	480		
T	37 128/30	Statua	497		
T	37 131/75	Statua	504		
T	37 180/87	Statua	476		
T	37 186/62	Statua	484		
T	37 186/83	Statua	484		
T	37 200/57	Statua	500		
T	37 200/100	Statua	500		
T	37 205/11	Oggettistica	496		
T	37 206/30	Statua	497		
T	37 208/57	Statua	500		
T	37 208/100	Statua	500		
T	37 210/67	Statua	477		
T	37 211/39	Statua	473		
T	37 211/50	Statua	473		
T	37 211/90	Statua	473		
T	37 219/30	Statua	497		
T	37 220/08	Statua	496		
T	37 221/06	Oggettistica	496		
T	37 235/83	Statua	477		
T	37 236/13	Oggettistica	496		
T	37 240/10	Statua	496		
T	37 243/90	Statua	476		
T	37 250/13	Statua	496		
T	37 251/104	Statua	486		
T	37 255/80	Statua	471		
T	37 266/110	Statua	485		
T	37 288/80	Statua	483		
T	37 404/100	Statua	493		
T	37 404/120	Statua	493		
T	37 440/93	Statua	473		
T	37 472/43	Statua	469		
T	37 472/57	Statua	469		
T	37 472/145	Statua	474		
T	37 500/73	Statua	473		
T	37 510/55	Statua	473		
T	37 552/175	Statua	487		
T	37 585/103	Statua	489		
T	37 608/115	Statua	491		
T	37 676/101	Statua	501		
T	37 690/101	Statua	490		
T	37 698/124	Statua	495		

OGGETTISTICA ORNAMENTALE

Codice Articolo	Descrizione	Pagina	Accessorio	
			Descrizione	Codice
T 37 700/35	Statua	490		
T 37 736/51	Statua	505		
T 37 736/80	Statua	505		
T 37 803/52	Statua	497		
T 37 820/63	Statua	494		
T 37 825/79	Statua	477		
T 37 860/90	Statua	476		
T 37 873/78	Statua	509		
T 37 916/89	Statua	486		
T 37 951/100	Statua	492		
T 37 984/80	Statua	489		
T 37 984/110	Statua	489		
T 37 990/89	Statua	489		
T 37 995/50	Statua	505		

39

39 000/07	Urna Cineraria	563		
39 001/26	Urna Cineraria	562		
39 020/24	Urna Cineraria	563		
39 050/26	Urna Cineraria	562		
39 080/26	Urna Cineraria	562		
39 100/28	Urna Cineraria	563		
39 150	Urna Cineraria	561		
39 160	Urna Cineraria	559		
39 170	Urna Cineraria	561		
39 180	Urna Cineraria	560		
39 190	Urna Cineraria	560		
39 202/21	Urna Cineraria	564		
39 246/16	Urna Cineraria	564		
39 268/24	Urna Cineraria	563		
39 408/06	Urna Cineraria	563		
39 410/06	Urna Cineraria	563		
39 593/07	Urna Cineraria	563		
39 593/10	Urna Cineraria	563		
39 603/29	Urna Cineraria	564		
39 607/27	Urna Cineraria	564		
39 609/29	Urna Cineraria	564		
39 611/25	Urna Cineraria	562		
39 637/25	Urna Cineraria	562		
39 659/25	Urna Cineraria	562		
39 663/25	Urna Cineraria	562		
39 667/32	Urna Cineraria	563		
39 684/25	Urna Cineraria	562		
39 709/25	Urna Cineraria	563		
39 755/25	Urna Cineraria	563		
39 764/25	Urna Cineraria	563		
39 823/25	Urna Cineraria	562		

60

P 60 001/13	Vaso	231,240,548	Int. Alluminio	96 601
P 60 001/20	Vaso	231	Int. Alluminio	96 055
P 60 003/13	Vaso	232,240,548	Int. Alluminio	96 601
P 60 003/20	Vaso	232	Int. Alluminio	96 055
P 60 007/10	Portaorchidea	240,548		
P 60 009/10	Portaorchidea	240,548		
T 60 010/20	Vaso	231	Int. Alluminio	96 055
T 60 010/29	Vaso	231	Int. Alluminio	96 532
T 60 011/23	Vaso	259		
T 60 012/20	Vaso	232	Int. Alluminio	96 055
T 60 012/29	Vaso	232	Int. Alluminio	96 532
P 60 015/13	Vaso	240,548	Int. Plastica	97 203
T 60 026/4	Vaso	240,548	Int. Plastica	97 203
P 60 037/13	Vaso	240,548	Int. Plastica	97 203
P 60 040/54	Vaso	253		
T 60 048/14	Vaso	240,548	Int. Plastica	97 203
P 60 050/19	Vaso	255		

OGGETTISTICA ORNAMENTALE

Codice Articolo	Descrizione	Pagina	Accessorio	
			Descrizione	Codice
P 60 055/54	Vaso	253		
P 60 070/54	Vaso	252		
P 60 083/54	Vaso	252		
P 60 117/19	Vaso	239	Int. Plastica	97 269
P 60 120/12	Vaso	240,548	Int. Alluminio	96 037
T 60 128/20	Vaso	239	Int. Plastica	97 269
P 60 139/19	Vaso	239	Int. Plastica	97 271
T 60 141/22	Vaso	239	Int. Plastica	97 271
P 60 150/20R	Vaso	226	Int. Alluminio	96 055
P 60 152/13	Vaso	240,548	Int. Plastica	97 395
P 60 152/18	Vaso	239	Int. Plastica	97 214
P 60 159/20R	Vaso	227	Int. Alluminio	96 055
T 60 163/14	Vaso	240,548	Int. Plastica	97 395
T 60 163/19	Vaso	239	Int. Plastica	97 214
P 60 168/20R	Vaso	252	Int. Rame	96 521
T 60 173/20R	Vaso	226	Int. Alluminio	96 055
P 60 174/19	Vaso	239	Int. Plastica	97 269
T 60 178/20R	Vaso	227	Int. Alluminio	96 055
P 60 180/18R	Vasca	226	Int. Rame	96 452
P 60 184/18R	Vasca	227	Int. Rame	96 452
T 60 185/21	Vaso	239	Int. Plastica	97 269
T 60 193/18R	Vasca	226	Int. Rame	96 452
P 60 196/18	Vaso	239	Int. Plastica	97 271
T 60 198/18R	Vasca	227	Int. Rame	96 452
T 60 208/22	Vaso	239	Int. Plastica	97 271
P 60 312/20	Vaso	234	Int. Plastica	97 191
T 60 323/20	Vaso	234	Int. Plastica	97 191
P 60 334/19	Vaso	238	Int. Plastica	97 236
T 60 345/21	Vaso	238	Int. Plastica	97 236
P 60 356/19	Vaso	238	Int. Plastica	97 236
T 60 367/21	Vaso	238	Int. Plastica	97 236
T 60 389/31	Vaso	238	Int. Plastica	97 305
T 60 403/31	Vaso	238	Int. Plastica	97 305
P 60 510/20	Vasca	233	Int. Plastica	97 495
P 60 675/19	Vaso	234	Int. Plastica	97 362
T 60 686/19	Vaso	234	Int. Plastica	97 362
P 60 697/19	Vaso	237	Int. Plastica	97 282
P 60 705/20R	Vaso	225	Int. Alluminio	96 055
P 60 711/19	Vaso	237	Int. Plastica	97 282
P 60 720/20R	Vaso	224,253	Int. Alluminio	96 055
P 60 733/20	Vaso	236	Int. Plastica	97 338
T 60 735/20R	Vaso	225	Int. Alluminio	96 055
T 60 740/20R	Vaso	224	Int. Alluminio	96 055
T 60 744/21	Vaso	236	Int. Plastica	97 338
P 60 755/20	Vaso	236	Int. Plastica	97 338
T 60 766/21	Vaso	236	Int. Plastica	97 338
P 60 777/20	Vaso	236	Int. Plastica	97 338
T 60 788/21	Vaso	236	Int. Plastica	97 338
P 60 808/18R	Vasca	225	Int. Rame	96 452
P 60 810/20	Vasca	233	Int. Plastica	97 495
P 60 820/18R	Vasca	224	Int. Rame	96 452
T 60 823/18R	Vasca	225	Int. Rame	96 452
P 60 835/19	Vaso	237	Int. Plastica	97 316
T 60 840/18R	Vasca	224	Int. Rame	96 452
T 60 846/21	Vaso	237	Int. Plastica	97 316
P 60 857/19	Vaso	236	Int. Plastica	97 316
T 60 868/21	Vaso	236	Int. Plastica	97 316
P 60 915/19	Vaso	235	Int. Plastica	97 407
T 60 926/19	Vaso	235	Int. Plastica	97 407
P 60 937/19	Vaso	235	Int. Plastica	97 407
T 60 948/19	Vaso	235	Int. Plastica	97 407
P 60 959/19	Vaso	235	Int. Plastica	97 338
T 60 961/21	Vaso	235	Int. Plastica	97 338
T 60 972/19	Vaso	235	Int. Plastica	97 407
T 60 983/21	Vaso	235	Int. Plastica	97 338

61

OGGETTISTICA ORNAMENTALE

	Codice Articolo	Descrizione	Pagina	Accessorio	
				Descrizione	Codice
P	61 016/19	Vaso	234	Int. Plastica	97 407
T	61 021/04	Vaso Inc.	231	Int. Alluminio	96 275
T	61 023/10	Vaso Inc.	231	Int. Alluminio	96 275
T	61 025/10	Vaso Inc.	232	Int. Alluminio	96 275
T	61 027/19	Vaso	234	Int. Plastica	97 407
P	61 175/19	Vaso	235	Int. Plastica	97 407
T	61 186/19	Vaso	235	Int. Plastica	97 407
P	61 197/19	Vaso	235	Int. Plastica	97 407
T	61 209/19	Vaso	235	Int. Plastica	97 407
P	61 233/20	Vaso	236	Int. Plastica	97 191
T	61 244/21	Vaso	236	Int. Plastica	97 191

63

P	63 111/19	Vaso	229	Int. Alluminio	96 463
T	63 122/19	Vaso	229	Int. Alluminio	96 463
P	63 133/16	Vasca	229	Int. Rame	96 452
P	63 140/20	Vaso	228	Int. Alluminio	96 055
P	63 142/17	Vasca	228	Int. Rame	96 452
P	63 155/15	Vasca	229	Int. Rame	96 452

66

P	66 010/19	Lampada Elett.	226	Fiamma Vetro	98 015
P	66 012/12	Lampada Elett.	240,548	Fiamma Polic.	97 511
P	66 015/24	Lampada Elett.	255		
P	66 018/19	Lampada Elett.	227	Fiamma Vetro	98 015
P	66 020/11	Lampada Elett.	259		
T	66 023/14	Lampada Elett.	240,548	Fiamma Polic.	97 511
T	66 030/19	Lampada Elett.	226	Fiamma Vetro	98 015
P	66 033/15	Lampada Elett.	253		
P	66 034/12	Lampada Elett.	240,548	Fiamma Polic.	97 511
T	66 037/19	Lampada Elett.	227	Fiamma Vetro	98 015
P	66 044/15	Lampada Elett.	253		
T	66 045/14	Lampada Elett.	240,548	Fiamma Polic.	97 511
P	66 070/19	Lampada Elett.	224	Fiamma Vetro	98 015
P	66 072/19	Lampada Elett.	225	Fiamma Vetro	98 015
P	66 075/15	Lampada Elett.	252		
T	66 080/19	Lampada Elett.	224	Fiamma Vetro	98 015
P	66 084/15	Lampada Elett.	252		
T	66 088/19	Lampada Elett.	225	Fiamma Vetro	98 015
P	66 101/15	Lampada Elett.	231,240,548	Fiamma Vetro	98 035
P	66 101/20	Lampada Elett.	231	Fiamma Vetro	98 015
P	66 103/15	Lampada Elett.	232,240,548	Fiamma Vetro	98 035
P	66 103/20	Lampada Elett.	232	Fiamma Vetro	98 015
T	66 110/20	Lampada Elett.	231	Fiamma Vetro	98 015
T	66 112/20	Lampada Elett.	232	Fiamma Vetro	98 015
P	66 114/16	Lampada Elett.	239	Fiamma Vetro	98 033
T	66 116/15	Lamp. Elett. Inc.	231	Fiamma Vetro	98 015
T	66 118/15	Lamp. Elett. Inc.	232	Fiamma Vetro	98 015
T	66 120/12	Lamp. Elett. Inc.	231	Fiamma Vetro	98 015
T	66 125/19	Lampada Elett.	239	Fiamma Vetro	98 033
P	66 136/18	Lampada Elett.	239	Fiamma Vetro	98 064
T	66 147/21	Lampada Elett.	239	Fiamma Vetro	98 064
P	66 171/12	Lampada Elett.	240,548	Fiamma Vetro	98 046
T	66 182/12	Lampada Elett.	240,548	Fiamma Vetro	98 046
P	66 193/16	Lampada Elett.	239	Fiamma Vetro	98 033
T	66 205/17	Lampada Elett.	239	Fiamma Vetro	98 033
P	66 250/20	Lampada Elett.	233	Fiamma Vetro	98 015
P	66 273/17	Lampada Elett.	234	Fiamma Vetro	98 033
T	66 284/17	Lampada Elett.	234	Fiamma Vetro	98 033
P	66 295/18	Lampada Elett.	238	Fiamma Vetro	98 033
T	66 307/20	Lampada Elett.	238	Fiamma Vetro	98 033
P	66 318/18	Lampada Elett.	238	Fiamma Vetro	98 033
T	66 329/20	Lampada Elett.	238	Fiamma Vetro	98 033
T	66 342/32	Lampada Elett.	238	Fiamma Vetro	98 088
T	66 364/32	Lampada Elett.	238	Fiamma Vetro	98 088
P	66 433/18	Lampada Elett.	237	Fiamma Vetro	98 033

OGGETTISTICA ORNAMENTALE

	Codice Articolo	Descrizione	Pagina	Accessorio	
				Descrizione	Codice
P	66 455/18	Lampada Elett.	237	Fiamma Vetro	98 033
P	66 477/12	Lampada Elett.	236	Cupoletta Vetro	92 958
T	66 488/14	Lampada Elett.	236	Cupoletta Vetro	92 958
T	66 513/10	Lampada Elett.	237	Cupoletta Vetro	92 947
T	66 524/12	Lampada Elett.	237	Cupoletta Vetro	92 947
P	66 535/10	Lampada Elett.	236	Cupoletta Vetro	92 947
T	66 546/12	Lampada Elett.	236	Cupoletta Vetro	92 947
P	66 672/16	Lampada Elett.	235	Fiamma Vetro	98 033
T	66 683/16	Lampada Elett.	235	Fiamma Vetro	98 033
P	66 694/16	Lampada Elett.	235	Fiamma Vetro	98 033
T	66 706/16	Lampada Elett.	235	Fiamma Vetro	98 033
P	66 739/12	Lampada Elett.	235	Cupoletta Vetro	92 958
T	66 741/14	Lampada Elett.	235	Cupoletta Vetro	92 958
P	66 752/16	Lampada Elett.	234	Fiamma Vetro	98 033
T	66 763/16	Lampada Elett.	234	Fiamma Vetro	98 033
P	66 774/12	Lampada Elett.	235	Cupoletta Vetro	92 958
T	66 785/14	Lampada Elett.	235	Cupoletta Vetro	92 958
P	66 832/16	Lampada Elett.	235	Fiamma Vetro	98 033
T	66 843/16	Lampada Elett.	235	Fiamma Vetro	98 033
P	66 854/16	Lampada Elett.	235	Fiamma Vetro	98 033
T	66 865/16	Lampada Elett.	235	Fiamma Vetro	98 033
P	66 876/12	Lampada Elett.	234	Cup. Metacr.	92 969
T	66 887/12	Lampada Elett.	234	Cup. Metacr.	92 969
P	66 912/17	Lampada Elett.	236	Fiamma Vetro	98 033
T	66 923/17	Lampada Elett.	236	Fiamma Vetro	98 033

67

P	67 500/19	Lampada Elett.	228	Fiamma Vetro	98 015
P	67 514/17	Lampada Elett.	229	Fiamma Vetro	98 015
T	67 525/17	Lampada Elett.	229	Fiamma Vetro	98 015
P	67 536/19	Lampada Elett.	229	Fiamma Vetro	98 015

68

T	68 010/22	Lampada Cero	237	Cristallo	98 002
P	68 014/17	Lampada Cero	239	Bicchieri	97 761
T	68 025/20	Lampada Cero	239	Bicchieri	97 761
P	68 036/23	Lampada Cero	239	Bicchieri	97 681
T	68 047/26	Lampada Cero	239	Bicchieri	97 681
P	68 116/17	Lampada Cero	234,237	Cristallo	98 911
T	68 127/20	Lampada Cero	234,237	Cristallo	98 911

71

P	71 018/09	Cornice	242		
P	71 020/08	Cornice	242		
P	71 020/09	Cornice	242		
P	71 020/11	Cornice	242		
P	71 031/09	Cornice	242		
P	71 053/09	Cornice	242		
P	71 075/08	Cornice	242		
P	71 075/09	Cornice	242		
P	71 075/11	Cornice	242		
P	71 097/07	Cornice	242		
P	71 097/08	Cornice	242		
P	71 097/09	Cornice	242		
P	71 097/11	Cornice	242		
P	71 097/13	Cornice	242		
P	71 111/06	Cornice	242		
P	71 111/07	Cornice	242		
P	71 111/08	Cornice	242		
P	71 111/09	Cornice	242		
P	71 111/11	Cornice	242		
P	71 121/09	Cornice	224,242		
P	71 121/11	Cornice	224,242		
P	71 182/09	Cornice	225,242		
P	71 182/11	Cornice	225,242		

OGGETTISTICA ORNAMENTALE

Codice Articolo	Descrizione	Pagina	Accessorio	
			Descrizione	Codice
P 71 519/09	Cornice	229,242		
P 71 519/11	Cornice	229,242		
P 71 823/09	Cornice	242		
P 71 823/11	Cornice	242		
P 71 823/13	Cornice	242		
P 71 823/18	Cornice	242		

72

P 72 054/09	Cornice	242		
P 72 098/08	Cornice	242		
P 72 098/09	Cornice	242		
P 72 098/10	Cornice	242		
P 72 098/11	Cornice	242		
P 72 098/13	Cornice	242		
P 72 212/09	Cornice	224,242		
P 72 212/10	Cornice	224,242		
P 72 212/11	Cornice	224,242		
P 72 324/09	Cornice	225,242		
P 72 324/10	Cornice	225,242		
P 72 324/11	Cornice	225,242		
P 72 511/09	Cornice	229,242		
P 72 511/10	Cornice	229,242		
P 72 600/12	Portafoto	241		
P 72 610/12	Portafoto	338		
P 72 620/17	Portafoto	241		
P 72 630/17	Portafoto	338		
P 72 640/14	Portafoto	241		
P 72 650/14	Portafoto	338		

73

P 73 025/03	Uccellino	550		
--------------------	-----------	-----	--	--

77

P 77 015/15	Croce	243		
P 77 015/20	Croce	243		
P 77 030/15	Croce	226,243		
P 77 030/20	Croce	226,243		
P 77 031/15	Croce	243		
P 77 031/20	Croce	243		
P 77 031/25	Croce	243		
P 77 031/30	Croce	243		
P 77 036/20	Croce	243		
P 77 037/15	Croce	243		
P 77 037/20	Croce	243		
P 77 038/20	Croce	243		
P 77 039/12	Croce	224,243		
P 77 039/15	Croce	224,243		
P 77 039/20	Croce	224,243		
P 77 039/30	Croce	224,243		
P 77 039/40	Croce	224,243		
P 77 040/15	Croce	227,243		
P 77 040/20	Croce	227,243		
P 77 059/11	Crocefisso	243		
P 77 059/20	Crocefisso	243		
P 77 059/27	Crocefisso	243		
P 77 072/15	Croce	243		
P 77 072/20	Croce	243		
P 77 072/25	Croce	243		
P 77 072/30	Croce	243		
P 77 094/08	Croce	243		
P 77 094/10	Croce	243		
P 77 094/12	Croce	243		
P 77 094/15	Croce	243		
P 77 094/20	Croce	243		
P 77 094/25	Croce	243		

OGGETTISTICA ORNAMENTALE

Codice Articolo	Descrizione	Pagina	Accessorio	
			Descrizione	Codice
P 77 094/30	Croce	243		
P 77 117/20	Croce	243		
P 77 117/25	Croce	243		
P 77 117/30	Croce	243		
P 77 119/12	Croce	225,243		
P 77 119/15	Croce	225,243		
P 77 119/20	Croce	225,243		
P 77 119/30	Croce	225,243		
P 77 119/40	Croce	225,243		
P 77 139/20	Croce	243		
P 77 139/25	Croce	243		
P 77 139/30	Croce	243		
P 77 222/06	Mensola	519		
P 77 516/20	Croce	229,243		
P 77 516/28	Croce	229,243		

78

P 78 001/20	Staffa	244		
P 78 002/20	Staffa	244		
P 78 309/00	Staffa	244		
P 78 309/10	Staffa	244		
P 78 311/00	Staffa	244		
P 78 311/10	Staffa	244		
P 78 322/10	Staffa	244		

79

P 79 017/03	Borchia	245		
P 79 017/04	Borchia	245		
P 79 017/05	Borchia	245		
P 79 028/03	Borchia	245		
P 79 052/03	Borchia	245		
P 79 052/04	Borchia	245		
P 79 052/05	Borchia	245		
P 79 063/03	Borchia	245		
P 79 063/04	Borchia	245		
P 79 063/05	Borchia	245		
P 79 074/45	Borchia	245		
P 79 079/830	Borchia	244		
P 79 079/840	Borchia	244		
P 79 079/855	Borchia	244		
P 79 161/30	Borchia	244		
P 79 161/40	Borchia	244		
P 79 161/55	Borchia	244		
T 79 350/04	Ghiera	245	Fiamma Vetro	98 044
T 79 350/05	Ghiera	245	Fiamma Vetro	98 055
T 79 350/06	Ghiera	245	Fiamma Vetro	98 066
T 79 369/12	Ghiera	245	Fiamma Vetro	98 033
T 79 369/13	Ghiera	245	Fiamma Vetro	98 033

80

P 80 050/100	Lamp. Pensile	245	Fiam. Goc. Oro ø 6 Piatto	98 128 98 142
---------------------	---------------	-----	------------------------------	------------------

95

P 95 006/0	Lumino	606		
P 95 008/10	Box Lumini	606		
P 95 010/0	Lumino	606		
P 95 015/0	Lumino	607		
P 95 019/14	Accumulatore	607		
P 95 024/0	Candela Elett.	605		
P 95 034/0	Fiore di luce	431		
P 95 036/0	Candela Elett.	604		
P 95 038/0	Candela Elett.	604		
P 95 043/0	Spatola Letterfix	608		

OGGETTISTICA ORNAMENTALE

	Codice Articolo	Descrizione	Pagina	Accessorio	
				Descrizione	Codice
	95 044/0	Cartucce Letterfix	608		
	95 046/0	Beccucci Letterfix	608		
	95 049/0	Candela Elett.	604		
	95 056/0	Kit Letterfix	608		
	95 060/0	Pistola Letterfix	608		
	95 066/0	Fiore di luce	431		
	95 067/0	Fiore di luce	431		
	95 068/12	Box Bronzonet	609		
	95 069/0	Lumino	606		
T	95 071/0	Piedistallo	595		
	95 074/300	Bronzonet	609		
	95 080	Marmo Clean	609		
	95 082/0	Fiore di luce	431		
	95 088/0	Fiore di luce	431		
T	95 089/0	Piedistallo	595		
T	95 097/0	Piedistallo	595		
P	95 098/15	Pannello Solare	385		
	95 099/0	Fiore di luce	431		
	95 103/0	Rainbow Verde	606		
	95 104/0	Rainbow Rossa	606		
	95 105/0	Rainbow Blu	606		
	95 106/0	Rainbow Multi.	606		
	95 107/0	Rainbow Neutra	606		
	95 113/0	Fiore di luce	431		
	95 118/0	Fiore di luce	431		
	95 119/4	Mobiletto	613		
	95 119/8	Mobiletto	613		
	95 123/0	Fiore di luce	431		
	95 125/0	Fiore di luce	431		
	95 140/0	Fiore di luce	431		
	95 145/0	Fiore di luce	431		
	95 165/0	Vetrina Ovale	615		
	95 180/0	Vetrina Quadrata	615		
	95 303/0	Cerniera	531		
	95 382/60	Zanca	531		
	95 382/80	Zanca	531		
	95 382/100	Zanca	531		
	95 382/150	Zanca	531		
	95 393/60	Vite per borchia	531		
	95 393/70	Vite per borchia	531		
	95 393/80	Vite per borchia	531		
	95 405/60	Perno	531		
	95 416/60	Vite Legno	531		
	95 507/60	Perno	531		
	95 507/80	Perno	531		
	95 609/60	Perno	531		
	95 609/80	Perno	531		
	95 820/100	Vite	528		
	95 831/100	Vite	528		
	95 905/6	Tassello Metall.	531		
	95 905/8	Tassello Metall.	531		
	95 905/10	Tassello Metall.	531		

98

	98 013/0	Fiamma Crist.ø 5	330		
	98 017/0	Fiamma Crist.ø 5	330		
	98 018/0	Fiamma Crist.ø 5	331		
	98 019/0	Fiamma Crist.ø 5	332		
	98 021/0	Fiamma Crist.ø 5	332		
	98 024/0	Fiamma Crist.ø 5	328		
	98 025/0	Fiamma Crist.ø 5	333		
	98 026/0	Fiamma Crist.ø 5	328		
	98 032/0	Fiamma Crist.ø 5	332		
	98 038/0	Fiamma Crist.ø 5	333		
	98 039/0	Fiamma Crist.ø 5	328		
	98 040/0	Fiamma Crist.ø 5	330		
	98 041/0	Fiamma Crist.ø 5	329		

OGGETTISTICA ORNAMENTALE

	Codice Articolo	Descrizione	Pagina	Accessorio	
				Descrizione	Codice
	98 042/0	Fiam. Crist.ø 5	330		
	98 053/0	Fiam. Crist.ø 4	329		
	98 084/0	Fiam. Crist.ø 5	329		
	98 086/0	Fiam. Crist.ø 5	329		
	98 107/0	Fiam. Crist.ø 5	331		
	98 109/0	Fiam. Crist.ø 5	331		
	98 113/0	Fiam. Crist.ø 5	331		
	98 115/0	Fiam. Crist.ø 5	331		
	98 117/0	Fiam. Crist.ø 5	329		
	98 121/0	Fiam. Crist.ø 5	329		
	98 128/0	Fiam. Goc. Oro ø 6	328		
	98 130/0	Fiam. Crist.ø 5	330		
	98 133/0	Fiam. Crist.ø 5	329		
	98 145/0	Fiam. Goc. Oro ø 5	328		
	98 150/0	Fiam. Goc. Oro ø 3,5	328		

99

	99 012/25	Punta Verde	610		
	99 012/30	Punta Verde	610		
	99 012/35	Punta Verde	610		
	99 012/40	Punta Verde	610		
	99 012/50	Punta Verde	610		
	99 012/60	Punta Verde	610		
	99 012/70	Punta Verde	610		
	99 012/80	Punta Verde	610		
	99 012/90	Punta Verde	610		
	99 012/100	Punta Verde	610		
	99 012/110	Punta Verde	610		
	99 012/120	Punta Verde	610		
	99 015/80	Punta Pantog.	610		
	99 015/100	Punta Pantog.	610		
	99 015/150	Punta Pantog.	610		
	99 023/30	Punta Oro	610		
	99 023/35	Punta Oro	610		
	99 023/40	Punta Oro	610		
	99 023/50	Punta Oro	610		
	99 023/60	Punta Oro	610		
	99 023/70	Punta Oro	610		
	99 023/80	Punta Oro	610		
	99 023/90	Punta Oro	610		
	99 023/100	Punta Oro	610		
	99 023/110	Punta Oro	610		
	99 023/120	Punta Oro	610		
	99 045/50	Scalpello	611		
	99 045/60	Scalpello	611		
	99 045/70	Scalpello	611		
	99 045/80	Scalpello	611		
	99 045/100	Scalpello	611		
	99 045/120	Scalpello	611		
	99 045/150	Scalpello	611		
	99 045/180	Scalpello	611		
	99 045/200	Scalpello	611		
	99 045/220	Scalpello	611		
	99 056/30	Scalp. a Mano	611		
	99 056/40	Scalp. a Mano	611		
	99 056/50	Scalp. a Mano	611		
	99 056/60	Scalp. a Mano	611		
	99 056/70	Scalp. a Mano	611		
	99 056/80	Scalp. a Mano	611		
	99 056/100	Scalp. a Mano	611		
	99 056/120	Scalp. a Mano	611		
	99 056/150	Scalp. a Mano	611		
	99 056/180	Scalp. a Mano	611		
	99 056/200	Scalp. a Mano	611		
	99 056/220	Scalp. a Mano	611		
	99 067/120	Gradina	612		
	99 067/150	Gradina	612		

OGGETTISTICA ORNAMENTALE

Codice Articolo	Descrizione	Pagina	Accessorio	
			Descrizione	Codice
99 067/180	Gradina	612		
99 067/200	Gradina	612		
99 067/220	Gradina	612		
99 070/62	Gradina	612		
99 070/63	Gradina	612		
99 070/83	Gradina	612		
99 070/84	Gradina	612		
99 070/103	Gradina	612		
99 070/104	Gradina	612		
99 070/105	Gradina	612		
99 070/124	Gradina	612		
99 070/125	Gradina	612		
99 070/153	Gradina	612		
99 070/154	Gradina	612		
99 070/155	Gradina	612		
99 078/40	Subbia a Mano	612		
99 078/50	Subbia a Mano	612		
99 078/60	Subbia a Mano	612		
99 078/80	Subbia a Mano	612		
99 078/100	Subbia a Mano	612		
99 089/40	Scalp. Basso	611		
99 089/50	Scalp. Basso	611		
99 089/60	Scalp. Basso	611		
99 089/70	Scalp. Basso	611		
99 089/80	Scalp. Basso	611		
99 089/100	Scalp. Basso	611		
99 091/80	Subbia	612		
99 091/100	Subbia	612		
99 091/120	Subbia	612		
99 103/50	Punta a Segno	611		
99 937	Placca Crem.	564		
99 940	Placca Crem.	564		
99 999/180	Display Gir.	616		
99 999/110	Esp. Cinerari	617		
99 999/210	Identity Disk	564		
99 999/227	Esp. Urne	616		

TARGHE			
Codice Articolo	Descrizione	Pagina	
T 0001	Targa Ovale cm. 30 x 20	314	
T 0005	Targa Rettangolare cm. 15 x 10	314	
T 0006	Targa Rettangolare cm. 35 x 23	314	
T 0007	Targa Rettangolare cm. 40 x 28	314	
T 0011	Targa Rettangolare cm. 22 x 15	314	
T 0012	Targa Rettangolare cm. 27 x 18	314	
T 0013	Targa Rettangolare cm. 50 x 30	314	
T 0015	Targa Ovale con Rose cm. 36 x 26	312	
T 0016	Targa Niilo cm. 36 x 26	313	
T 0017	Targa Claudia cm. 36 x 27	313	
T 0023	Targa Ovale cm. 36 x 22	312	
T 0024	Targa Decò cm. 43 x 23	313	
T 0025	Targa Giglio cm. 37 x 24	312	
T 0026	Targa Ovale cm. 17 x 10	314	
T 0029	Targa Rettangolare cm. 15 x 15	314	
T 0043	Targa Rettangolare cm. 20 x 10	314	
T 0045	Targa Rettangolare cm. 20 x 20	314	
T 0048	Targa Rettangolare cm. 25 x 10	314	
T 0050	Targa Rettangolare cm. 25 x 25	314	
T 0053	Targa Rettangolare cm. 30 x 15	314	
T 0055	Targa Rettangolare cm. 30 x 20	314	
T 0057	Targa Rettangolare cm. 30 x 25	314	
T 0059	Targa Rettangolare cm. 30 x 30	314	
T 0061	Targa Rettangolare cm. 35 x 15	314	
T 0063	Targa Rettangolare cm. 35 x 30	314	
T 0065	Targa Rettangolare cm. 35 x 35	314	
T 0068	Targa Rettangolare cm. 40 x 20	314	
T 0070	Targa Rettangolare cm. 40 x 40	314	
T 0073	Targa Rettangolare cm. 45 x 20	314	
T 0075	Targa Rettangolare cm. 45 x 25	314	
T 0077	Targa Rettangolare cm. 45 x 30	314	
T 0079	Targa Rettangolare cm. 45 x 45	314	
T 0081	Targa Rettangolare cm. 45 x 38	314	
T 0083	Targa Rettangolare cm. 50 x 20	314	
T 0085	Targa Rettangolare cm. 50 x 25	314	
T 0088	Targa Rettangolare cm. 50 x 35	314	
T 0090	Targa Rettangolare cm. 50 x 40	314	
T 0092	Targa Rettangolare cm. 50 x 45	314	
T 0094	Targa Rettangolare cm. 60 x 25	314	
T 0096	Targa Rettangolare cm. 60 x 30	314	
T 0098	Targa Rettangolare cm. 60 x 35	314	
T 0100	Targa Rettangolare cm. 60 x 40	314	
T 0102	Targa Rettangolare cm. 60 x 45	314	
T 0105	Targa Circolare ø cm. 30	314	
T 0109	Targa Ovale cm. 25 x 17	314	
T 0116	Targa Ovale cm. 36 x 26	314	
T 0133	Targa Ovale con Angioletto cm. 36 x 26	312	
T 0134	Targa Ovale con Madonna cm. 36 x 26	312	
T 0135	Targa Ovale con Cristo cm. 36 x 26	312	
T 0136	Targa Rettangolare cm. 60 x 10	314	
T 0137	Targa Rettangolare cm. 60 x 15	314	
T 0138	Targa Rettangolare cm. 60 x 20	314	
T 0139	Targa Rettangolare cm. 75 x 10	314	
T 0140	Targa Rettangolare cm. 75 x 15	314	
T 0141	Targa Rettangolare cm. 75 x 20	314	
T 0142	Targa Rettangolare cm. 90 x 10	314	
T 0143	Targa Rettangolare cm. 90 x 15	314	
T 0144	Targa Rettangolare cm. 90 x 20	314	
T 0176	Targa Niilo cm. 18 x 12	313	
T 0177	Targa Decò cm. 24 x 12	313	
T 0178	Targa Giglio cm. 18 x 12	312	
T 0179	Targa Pergamena cm. 21 x 15	304	
T 0180	Targa Pergamena cm. 28 x 20	304	
T 0181	Targa Pergamena cm. 35 x 25	304	
T 0183	Targa Circolare ø cm. 45	314	
T 0189	Targa Rettangolare cm. 60 x 50	314	
T 0190	Targa Rettangolare cm. 70 x 45	314	
T 0191	Targa Pergamena cm. 15 x 10	304	
T 0192	Targa Pergamena cm. 20 x 11	304	

TARGHE			
Codice Articolo	Descrizione	Pagina	
T 0234	Targa Ondulata cm. 27 x 18	313	
T 0237	Targa Concava Spigoli Tondi cm. 27 x 18	313	
T 0238	Targa Concava Spigoli Vivi cm. 27 x 18	313	
T 0246	Targa Rettangolare cm. 60 X 60	314	
T 0247	Targa Rettangolare cm. 75 x 30	314	
T 0248	Targa Rettangolare cm. 75 x 46	314	
T 0249	Targa Rettangolare cm. 75 x 50	314	
T 0250	Targa Rettangolare cm. 75 x 60	314	
T 0251	Targa Rettangolare cm. 75 x 75	314	
T 0252	Targa Rettangolare cm. 85 x 65	314	
T 0253	Targa Rettangolare cm. 90 x 50	314	
T 0254	Targa Rettangolare cm. 90 x 60	314	
T 0255	Targa Rettangolare cm. 90 x 75	314	
T 0256	Targa Rettangolare cm. 90 x 90	314	
T 0257	Targa Rettangolare cm. 100 x 50	314	
T 0258	Targa Rettangolare cm. 100 x 70	314	
T 0259	Targa Rettangolare cm. 105 x 90	314	
T 0260	Targa Rettangolare cm. 120 x 90	314	
T 0261	Targa Circolare ø cm. 60	314	
T 0262	Targa Circolare ø cm. 75	314	
T 0263	Targa Circolare ø cm. 90	314	
T 0264	Targa Circolare ø cm. 120	314	
T 0265	Targhetta cm. 8 x 4 (ord.minimo 50 pz.)	313	
T 0310	Targhetta cm. 8 x 4 (ord.minimo 50 pz.)	313	

TARGHE MOMENTI MAGICI			
Codice Articolo	Descrizione	Pagina	
	al cm ² (per targa fino a 500 cm ²)	311	
	al cm ² (per targa da 501 a 1000 cm ²)	311	
	al cm ² (per targa oltre 1000 cm ²)	311	

PORCELLANA

PORCELLANA

Codice Articolo	Descrizione	Pagina	Accessorio	
			Descrizione	Codice
P PO 133/13	Vaso	207,546	Int. Plastica	97 431
P PO 133/21	Vaso	207	Int. Plastica	97 444
T PO 134/21	Vaso	207	Int. Plastica	97 444
P PO 135/18	Vasca	207	Int. Plastica	97 024
T PO 136/18	Vasca	207	Int. Plastica	97 024
P PO 137/13	Vaso	211,546	Int. Plastica	97 431
P PO 137/21	Vaso	211	Int. Plastica	97 444
T PO 138/21	Vaso	211	Int. Plastica	97 444
P PO 139/20	Vasca	211	Int. Plastica	97 024
T PO 140/20	Vasca	211	Int. Plastica	97 024
P PO 165/13	Vaso	208,547	Int. Plastica	97 431
P PO 165/21	Vaso	208	Int. Plastica	97 442
T PO 166/21	Vaso	208	Int. Plastica	97 442
P PO 167/18	Vasca	208	Int. Plastica	97 021
T PO 168/18	Vasca	208	Int. Plastica	97 021
P PO 169/13	Vaso	213,547	Int. Plastica	97 431
P PO 169/21	Vaso	213	Int. Plastica	97 442
T PO 170/21	Vaso	213	Int. Plastica	97 442
P PO 171/20	Vasca	213	Int. Plastica	97 021
T PO 172/20	Vasca	213	Int. Plastica	97 021
P PO 173/13	Vaso	206,546	Int. Plastica	97 431
P PO 173/21	Vaso	206	Int. Plastica	97 444
T PO 174/21	Vaso	206	Int. Plastica	97 444
P PO 175/18	Vasca	206	Int. Plastica	97 024
T PO 176/18	Vasca	206	Int. Plastica	97 024
P PO 177/13	Vaso	205,546	Int. Plastica	97 431
P PO 177/21	Vaso	205	Int. Plastica	97 444
T PO 178/21	Vaso	205	Int. Plastica	97 444
P PO 179/18	Vasca	205	Int. Plastica	97 024
T PO 180/18	Vasca	205	Int. Plastica	97 024
P PO 181/13	Vaso	209,547	Int. Plastica	97 431
P PO 181/21	Vaso	209	Int. Plastica	97 442
T PO 182/21	Vaso	209	Int. Plastica	97 442
P PO 183/18	Vasca	209	Int. Plastica	97 021
T PO 184/18	Vasca	209	Int. Plastica	97 021
P PO 189/13	Vaso	210,546	Int. Plastica	97 431
P PO 189/21	Vaso	210	Int. Plastica	97 444
T PO 190/21	Vaso	210	Int. Plastica	97 444
P PO 191/20	Vasca	210	Int. Plastica	97 024
T PO 192/20	Vasca	210	Int. Plastica	97 024
P PO 193/13	Vaso	212,547	Int. Plastica	97 431
P PO 193/21	Vaso	212	Int. Plastica	97 442
T PO 194/21	Vaso	212	Int. Plastica	97 442
P PO 195/20	Vasca	212	Int. Plastica	97 021
T PO 196/20	Vasca	212	Int. Plastica	97 021
P PO 197/21	Vaso	214	Int. Plastica	97 444
T PO 198/21	Vaso	214	Int. Plastica	97 444
P PO 199/20	Vasca	214	Int. Plastica	97 024
T PO 200/20	Vasca	214	Int. Plastica	97 024
P PO 201/21	Vaso	215	Int. Plastica	97 442
T PO 202/21	Vaso	215	Int. Plastica	97 442
P PO 203/20	Vasca	215	Int. Plastica	97 021
T PO 204/20	Vasca	215	Int. Plastica	97 021
P PO 205/13	Vaso	216,546	Int. Plastica	97 431
P PO 205/20	Vaso	216	Int. Plastica	97 444
T PO 206/20	Vaso	216	Int. Plastica	97 444
P PO 207/19	Vasca	216	Int. Plastica	97 024
T PO 208/19	Vasca	216	Int. Plastica	97 024
P PO 209/13	Vaso	217,547	Int. Plastica	97 431
P PO 209/20	Vaso	217	Int. Plastica	97 442
T PO 210/20	Vaso	217	Int. Plastica	97 442
P PO 211/19	Vasca	217	Int. Plastica	97 021
T PO 212/19	Vasca	217	Int. Plastica	97 021
P PO 213/13	Vaso	218,546	Int. Plastica	97 431
P PO 213/20	Vaso	218	Int. Plastica	97 444
T PO 214/20	Vaso	218	Int. Plastica	97 444
P PO 215/18	Vasca	218	Int. Plastica	97 024
T PO 216/18	Vasca	218	Int. Plastica	97 024

Codice Articolo	Descrizione	Pagina	Accessorio	
			Descrizione	Codice
P PO 217/20	Vaso	220	Int. Plastica	97 444
T PO 218/20	Vaso	220	Int. Plastica	97 444
P PO 219/18	Vasca	220	Int. Plastica	97 024
T PO 220/18	Vasca	220	Int. Plastica	97 024
P PO 221/13	Vaso	219,547	Int. Plastica	97 431
P PO 221/20	Vaso	219	Int. Plastica	97 442
T PO 222/20	Vaso	219	Int. Plastica	97 442
P PO 223/18	Vasca	219	Int. Plastica	97 021
T PO 224/18	Vasca	219	Int. Plastica	97 021
P PO 717/15	Lamp. Elett.	207,546	Fiamma Vetro	98 044
P PO 717/20	Lamp. Elett.	207	Fiamma Vetro	98 055
T PO 718/20	Lamp. Elett.	207	Fiamma Vetro	98 055
P PO 733/15	Lamp. Elett.	208,547	Fiamma Vetro	98 044
P PO 733/20	Lamp. Elett.	208	Fiamma Vetro	98 055
T PO 734/20	Lamp. Elett.	208	Fiamma Vetro	98 055
P PO 735/15	Lamp. Elett.	213,547	Fiamma Vetro	98 044
P PO 735/21	Lamp. Elett.	213	Fiamma Vetro	98 055
T PO 736/21	Lamp. Elett.	213	Fiamma Vetro	98 055
P PO 737/15	Lamp. Elett.	206,546	Fiamma Vetro	98 044
P PO 737/20	Lamp. Elett.	206	Fiamma Vetro	98 055
T PO 738/20	Lamp. Elett.	206	Fiamma Vetro	98 055
P PO 739/15	Lamp. Elett.	205,546	Fiamma Vetro	98 044
P PO 739/20	Lamp. Elett.	205	Fiamma Vetro	98 055
T PO 740/20	Lamp. Elett.	205	Fiamma Vetro	98 055
P PO 741/15	Lamp. Elett.	209,547	Fiamma Vetro	98 044
P PO 741/20	Lamp. Elett.	209	Fiamma Vetro	98 055
T PO 742/20	Lamp. Elett.	209	Fiamma Vetro	98 055
P PO 745/15	Lamp. Elett.	210,546	Fiamma Vetro	98 044
P PO 745/21	Lamp. Elett.	210	Fiamma Vetro	98 055
T PO 746/21	Lamp. Elett.	210	Fiamma Vetro	98 055
P PO 747/15	Lamp. Elett.	212,547	Fiamma Vetro	98 044
P PO 747/21	Lamp. Elett.	212	Fiamma Vetro	98 055
T PO 748/21	Lamp. Elett.	212	Fiamma Vetro	98 055
P PO 749/21	Lamp. Elett.	214	Fiamma Vetro	98 055
T PO 750/21	Lamp. Elett.	214	Fiamma Vetro	98 055
P PO 751/21	Lamp. Elett.	215	Fiamma Vetro	98 055
T PO 752/21	Lamp. Elett.	215	Fiamma Vetro	98 055
P PO 753/15	Lamp. Elett.	211,546	Fiamma Vetro	98 044
P PO 753/21	Lamp. Elett.	211	Fiamma Vetro	98 055
T PO 754/21	Lamp. Elett.	211	Fiamma Vetro	98 055
P PO 755/15	Lamp. Elett.	216,546	Fiamma Vetro	98 044
P PO 755/19	Lamp. Elett.	216	Fiamma Vetro	98 055
T PO 756/19	Lamp. Elett.	216	Fiamma Vetro	98 055
P PO 757/15	Lamp. Elett.	217,547	Fiamma Vetro	98 044
P PO 757/19	Lamp. Elett.	217	Fiamma Vetro	98 055
T PO 758/19	Lamp. Elett.	217	Fiamma Vetro	98 055
P PO 759/15	Lamp. Elett.	218,546	Fiamma Vetro	98 044
P PO 759/20	Lamp. Elett.	218	Fiamma Vetro	98 055
T PO 760/20	Lamp. Elett.	218	Fiamma Vetro	98 055
P PO 761/20	Lamp. Elett.	220	Fiamma Vetro	98 055
T PO 762/20	Lamp. Elett.	220	Fiamma Vetro	98 055
P PO 763/15	Lamp. Elett.	219,546	Fiamma Vetro	98 044
P PO 763/20	Lamp. Elett.	219	Fiamma Vetro	98 055
T PO 764/20	Lamp. Elett.	219	Fiamma Vetro	98 055
P P1 909/09	Cornice	221		
P P1 909/11	Cornice	221		
P P1 910/09	Cornice	221		
P P1 910/11	Cornice	221		
P P2 109/09	Cornice	221		
P P2 109/11	Cornice	221		
P P2 110/09	Cornice	221		
P P2 110/11	Cornice	221		
P P2 201/05	Pergamena	221		
P P2 201/07	Pergamena	221		
P P2 201/09	Pergamena	221		
P P2 201/12	Pergamena	221		
P P2 201/15	Pergamena	221		
P P2 313/13	Croce	221		

PORCELLANA

Codice Articolo	Descrizione	Pagina	Accessorio	
			Descrizione	Codice
P P2 313/17	Croce	221		
P P2 313/22	Croce	221		
P P2 313/26	Croce	221		
P P2 314/13	Croce	221		
P P2 314/17	Croce	221		
P P2 314/22	Croce	221		
P P2 314/26	Croce	221		
P P3 107/14	Targa	221		
P P3 107/17	Targa	221		
P P3 108/14	Targa	221		
P P3 108/17	Targa	221		
P P3 109/14	Targa	221		
P P3 109/18	Targa	221		
P P3 110/14	Targa	221		
P P3 110/17	Targa	221		
P P3 111/14	Targa	221		
P P3 111/17	Targa	221		
P P3 112/14	Targa	221		
P P3 112/18	Targa	221		

FOTOCERAMICHE

Codice Articolo	Descrizione
F0123/06	Fotoceramica Boemia in b/n cm.6 x 8
F0123/07	Fotoceramica Boemia in b/n cm.7 x 9
F0123/08	Fotoceramica Boemia in b/n cm.8 x 10
F0123/09	Fotoceramica Boemia in b/n cm.9 x 11
F0123/11	Fotoceramica Boemia in b/n cm.11 x 14
F0126/06	Fotoceramica Boemia a colori cm.6 x 8
F0126/07	Fotoceramica Boemia a colori cm.7 x 9
F0126/08	Fotoceramica Boemia a colori cm.8 x 10
F0126/09	Fotoceramica Boemia a colori cm.9 x 11
F0126/11	Fotoceramica Boemia a colori cm.11 x 14
F0193/05	Fotoceramica Ovale in b/n cm.5 x 7
F0193/06	Fotoceramica Ovale in b/n cm.6 x 8
F0193/07	Fotoceramica Ovale in b/n cm.7 x 9
F0193/08	Fotoceramica Ovale in b/n cm.8 x 10
F0193/09	Fotoceramica Ovale in b/n cm.9 x 12
F0193/10	Fotoceramica Ovale in b/n cm.10 x 13
F0193/11	Fotoceramica Ovale in b/n cm.11 x 15
F0193/13	Fotoceramica Ovale in b/n cm.13 x 18
F0193/18	Fotoceramica Ovale in b/n cm.18 x 24
F0193/24	Fotoceramica Ovale in b/n cm.24 x 30
F0196/05	Fotoceramica Ovale a colori cm.5 x 7
F0196/06	Fotoceramica Ovale a colori cm.6 x 8
F0196/07	Fotoceramica Ovale a colori cm.7 x 9
F0196/08	Fotoceramica Ovale a colori cm.8 x 10
F0196/09	Fotoceramica Ovale a colori cm.9 x 12
F0196/10	Fotoceramica Ovale a colori cm.10 x 13
F0196/11	Fotoceramica Ovale a colori cm.11 x 15
F0196/13	Fotoceramica Ovale a colori cm.13 x 18
F0196/18	Fotoceramica Ovale a colori cm.18 x 24
F0196/24	Fotoceramica Ovale a colori cm.24 x 30
F0210/20	Fotoceramica Quadrata colori cm.20 x 20
F0213/06	Fotoceramica Rettang. in b/n cm.6 x 8
F0213/07	Fotoceramica Rettang. in b/n cm.7 x 9
F0213/08	Fotoceramica Rettang. in b/n cm.8 x 10
F0213/09	Fotoceramica Rettang. in b/n cm.9 x 12
F0213/10	Fotoceramica Rettang. in b/n cm.10 x 15
F0213/11	Fotoceramica Rettang. in b/n cm.11 x 15
F0213/13	Fotoceramica Rettang. in b/n cm.13 x 18
F0213/16	Fotoceramica Rettang. in b/n cm.16 x 20
F0213/18	Fotoceramica Rettang. in b/n cm.18 x 24
F0213/24	Fotoceramica Rettang. in b/n cm.24 x 30
F0216/06	Fotoceramica Rettang. colori cm.6 x 8
F0216/07	Fotoceramica Rettang. colori cm.7 x 9
F0216/08	Fotoceramica Rettang. colori cm.8 x 10
F0216/09	Fotoceramica Rettang. colori cm.9 x 12
F0216/10	Fotoceramica Rettang. colori cm.10 x 15
F0216/11	Fotoceramica Rettang. colori cm.11 x 15
F0216/13	Fotoceramica Rettang. colori cm.13 x 18
F0216/14	Fotoceramica Rettang. colori cm.14,5 x 17
F0216/16	Fotoceramica Rettang. colori cm.16 x 20
F0216/18	Fotoceramica Rettang. colori cm.18 x 24
F0216/24	Fotoceramica Rettang. colori cm.24 x 30
F0302/20	Fotocristallo colori con Led cm.20
F0333/00	Maggiorazione per bordo oro
F0443/00	Fotominiatura in b/n
F0446/00	Fotominiatura a colori
F0555/00	Maggiorazione per fotoritocco
F0666/00	Maggiorazione per filo oro
F0111/00	Fotoceramica in seppia Maggioraz.30% dal b/n
F0222/00	Elab. da b/n a colori Maggiorazione 30%
F0777/00	Fotoceramica a 2 teste Maggiorazione 50%

CRISTALLI DI LUCE		
Codice Articolo	Descrizione	Pagina
C4542/32	Cristallo di Luce 32X17	595
C4542/36	Cristallo di Luce 36X19	595
C4542/40	Cristallo di Luce 40X21	595
C4543/25	Cristallo di Luce 25X10	595
C4543/30	Cristallo di Luce 30X12	595
C4543/35	Cristallo di Luce 35X14	595
C4543/40	Cristallo di Luce 40X16	595
C4544/10	Cristallo di Luce 10X25	595
C4544/12	Cristallo di Luce 12X30	595
C4544/14	Cristallo di Luce 14X35	595
C4544/16	Cristallo di Luce 16X40	595

“EMOZIONALI”

C5011/20	Cristallo di Luce 20X15	587
C5011/24	Cristallo di Luce 24X18	587
C5011/28	Cristallo di Luce 28X21	587
C5011/32	Cristallo di Luce 32X24	587
C5011/36	Cristallo di Luce 36X27	587
C5011/40	Cristallo di Luce 40X30	587
C5012/20	Cristallo di Luce 20X10,5	587
C5012/24	Cristallo di Luce 24X13	587
C5012/28	Cristallo di Luce 28X15	587
C5012/32	Cristallo di Luce 32X17	587
C5012/36	Cristallo di Luce 36X19	587
C5012/40	Cristallo di Luce 40X21	587
C5013/25	Cristallo di Luce 25X10	587
C5013/30	Cristallo di Luce 30X12	587
C5013/35	Cristallo di Luce 35X14	587
C5013/40	Cristallo di Luce 40X16	587
C5014/10	Cristallo di Luce 10X25	587
C5014/12	Cristallo di Luce 12X30	587
C5014/14	Cristallo di Luce 14X35	587
C5014/16	Cristallo di Luce 16X40	587
C5021/20	Cristallo di Luce 20X15	587
C5021/24	Cristallo di Luce 24X18	587
C5021/28	Cristallo di Luce 28X21	587
C5021/32	Cristallo di Luce 32X24	587
C5021/36	Cristallo di Luce 36X27	587
C5021/40	Cristallo di Luce 40X30	587
C5022/20	Cristallo di Luce 20X10,5	587
C5022/24	Cristallo di Luce 24X13	587
C5022/28	Cristallo di Luce 28X15	587
C5022/32	Cristallo di Luce 32X17	587
C5022/36	Cristallo di Luce 36X19	587
C5022/40	Cristallo di Luce 40X21	587
C5023/25	Cristallo di Luce 25X10	587
C5023/30	Cristallo di Luce 30X12	587
C5023/35	Cristallo di Luce 35X14	587
C5023/40	Cristallo di Luce 40X16	587
C5024/10	Cristallo di Luce 10X25	587
C5024/12	Cristallo di Luce 12X30	587
C5024/14	Cristallo di Luce 14X35	587
C5024/16	Cristallo di Luce 16X40	587
C5511/20	Cristallo di Luce 20X15	588
C5511/24	Cristallo di Luce 24X18	588
C5511/28	Cristallo di Luce 28X21	588
C5511/32	Cristallo di Luce 32X24	588
C5511/36	Cristallo di Luce 36X27	588
C5511/40	Cristallo di Luce 40X30	588
C5512/20	Cristallo di Luce 20X10,5	588
C5512/24	Cristallo di Luce 24X13	588
C5512/28	Cristallo di Luce 28X15	588
C5512/32	Cristallo di Luce 32X17	588
C5512/36	Cristallo di Luce 36X19	588
C5512/40	Cristallo di Luce 40X21	588
C5513/25	Cristallo di Luce 25X10	588
C5513/30	Cristallo di Luce 30X12	588
C5513/35	Cristallo di Luce 35X14	588
C5513/40	Cristallo di Luce 40X16	588

CRISTALLI DI LUCE		
Codice Articolo	Descrizione	Pagina
C5514/10	Cristallo di Luce 10X25	588
C5514/12	Cristallo di Luce 12X30	588
C5514/14	Cristallo di Luce 14X35	588
C5514/16	Cristallo di Luce 16X40	588
C5521/20	Cristallo di Luce 20X15	588
C5521/24	Cristallo di Luce 24X18	588
C5521/28	Cristallo di Luce 28X21	588
C5521/32	Cristallo di Luce 32X24	588
C5521/36	Cristallo di Luce 36X27	588
C5521/40	Cristallo di Luce 40X30	588
C5522/20	Cristallo di Luce 20X10,5	588
C5522/24	Cristallo di Luce 24X13	588
C5522/28	Cristallo di Luce 28X15	588
C5522/32	Cristallo di Luce 32X17	588
C5522/36	Cristallo di Luce 36X19	588
C5522/40	Cristallo di Luce 40X21	588
C5523/25	Cristallo di Luce 25X10	588
C5523/30	Cristallo di Luce 30X12	588
C5523/35	Cristallo di Luce 35X14	588
C5523/40	Cristallo di Luce 40X16	588
C5524/10	Cristallo di Luce 10X25	588
C5524/12	Cristallo di Luce 12X30	588
C5524/14	Cristallo di Luce 14X35	588
C5524/16	Cristallo di Luce 16X40	588

“QUADRATI”

C6060/10	Cris. di Luce Quadrato 10X10	567
C6060/13	Cris. di Luce Quadrato 13X13	567
C6060/15	Cris. di Luce Quadrato 15X15	567

ACCESSORI		
Codice Articolo		Descrizione
79 311/04		Ghiera acciaio
79 311/05		Ghiera acciaio
92 947		Cupoletta Vetro
92 958		Cupoletta Vetro
92 969		Cupoletta Metacr.
95 998		Interno
95 999		Interno
96 003		Int. Alluminio
96 005		Int. Rame
96 007		Int. Alluminio
96 008		Int. Rame
96 010		Int. Alluminio
96 012		Int. Alluminio
96 018		Int. Alluminio
96 022		Int. Plastica
96 026		Int. Rame
96 029		Int. Rame
96 030		Int. Rame
96 031		Int. Rame
96 037		Int. Alluminio
96 042		Int. Rame
96 047		Int. Rame
96 049		Int. Alluminio
96 050		Int. Alluminio
96 051		Int. Alluminio
96 052		Int. Alluminio
96 055		Int. Alluminio
96 056		Int. Alluminio
96 057		Int. Alluminio
96 058		Int. Alluminio
96 059		Int. Alluminio
96 062		Int. Alluminio
96 064		Int. Rame
96 066		Int. Alluminio
96 068		Int. Alluminio
96 100		Int. Alluminio
96 130		Int. Rame
96 133		Int. Rame
96 144		Interno
96 155		Int. Alluminio
96 166		Int. Rame
96 177		Int. Rame
96 188		Int. Rame
96 199		Int. Rame
96 205		Int. Rame
96 224		Int. Alluminio
96 235		Int. Rame
96 242		Int. Rame
96 246		Int. Rame
96 250		Int. Rame
96 257		Int. Rame
96 275		Int. Alluminio
96 279		Int. Rame
96 280		Int. Rame
96 281		Int. Rame
96 290		Int. Alluminio
96 292		Int. Alluminio
96 294		Int. Alluminio
96 304		Int. Rame
96 308		Int. Alluminio
96 315		Int. Rame
96 320		Int. Alluminio
96 322		Int. Alluminio
96 326		Int. Rame
96 330		Int. Alluminio
96 332		Int. Alluminio
96 350		Int. Alluminio
96 406		Int. Rame
96 432		Portacero Rame

ACCESSORI		
Codice Articolo		Descrizione
96 437		Portalamp. Allum.
96 439		Portacero Rame
96 450		Int. Alluminio
96 452		Int. Rame
96 454		Int. Rame
96 463		Int. Alluminio
96 485		Int. Rame
96 496		Int. Rame
96 521		Int. Rame
96 523		Int. Alluminio
96 532		Int. Alluminio
96 565		Int. Alluminio
96 576		Int. Rame
96 601		Int. Alluminio
96 610		Int. Alluminio
96 634		Int. Rame
96 636		Int. Rame
96 638		Int. Rame
96 641		Int. Alluminio
96 645		Int. Alluminio
96 656		Int. Rame
96 660		Int. Alluminio
96 667		Int. Rame
96 714		Int. Rame
96 758		Int. Alluminio
97 005		Int. Plastica
97 006		Int. Plastica
97 010		Int. Plastica
97 012		Int. Plastica
97 014		Int. Plastica
97 019		Int. Plastica
97 021		Int. Plastica
97 024		Int. Plastica
97 026		Int. Plastica
97 029		Int. Plastica
97 032		Int. Plastica
97 035		Int. Plastica
97 043		Int. Plastica
97 051		Int. Plastica
97 056		Int. Plastica
97 057		Int. Plastica
97 058		Int. Plastica
97 064		Int. Plastica
97 065		Int. Plastica
97 068		Int. Plastica
97 112		Int. Plastica
97 122		Int. Plastica
97 191		Int. Plastica
97 203		Int. Plastica
97 214		Int. Plastica
97 236		Int. Plastica
97 269		Int. Plastica
97 271		Int. Plastica
97 282		Int. Plastica
97 305		Int. Plastica
97 316		Int. Plastica
97 327		Int. Plastica
97 338		Int. Plastica
97 349		Int. Plastica
97 362		Int. Plastica
97 395		Int. Plastica
97 407		Int. Plastica
97 431		Int. Plastica
97 442		Int. Plastica
97 444		Int. Plastica
97 464		Int. Plastica
97 468		Int. Plastica
97 475		Int. Plastica
97 486		Int. Plastica

ACCESSORI		
Codice Articolo		Descrizione
97 495		Int. Plastica
97 511		Fiamma Policarb.
97 513		Fiamma
97 515		Fiamma in Plex
97 516		Fiamma Plex
97 517		Fiamma Plex
97 518		Fiamma Plex
97 600		Bicchiere
97 613		Bicchiere
97 624		Bicchiere
97 635		Bicchiere
97 646		Bicchiere
97 657		Bicchiere
97 668		Bicchiere
97 681		Bicchiere
97 715		Bicchiere
97 726		Bicchiere
97 761		Bicchiere
98 002		Cristallo
98 006		Cristallo
98 015		Fiamma Vetro
98 022		Fiamma Vetro
98 027		Cristallo
98 031		Cristallo
98 033		Fiamma Vetro
98 035		Fiamma Vetro
98 043		Fiamma Vetro
98 044		Fiamma Vetro
98 046		Fiamma Vetro
98 048		Fiamma Vetro
98 055		Fiamma Vetro
98 060		Fiamma Vetro
98 064		Fiamma Vetro
98 066		Fiamma Vetro
98 088		Fiamma Vetro
98 102		Fiamma Vetro
98 106		Cristallo Iridescente
98 110		Bicchiere
98 122		Cristallo
98 135		Cristallo
98 137		Cristallo
98 139		Cristallo
98 142		Piatto
98 143		Bicchiere
98 146		Cristallo
98 148		Cristallo
98 165		Cristallo
98 170		Vetro
98 175		Vetro
98 177		Vetro
98 180		Vetro
98 183		Vetro
98 185		Vetro
98 187		Vetro
98 189		Vetro
98 192		Cristallo
98 200		Cristallo
98 237		Cristallo Conico
98 247		Cristallo Conico
98 260		Cristallo
98 272		Cristallo
98 274		Cristallo
98 277		Cristallo
98 280		Cristallo
98 281		Cristallo
98 283		Vetro
98 286		Cristallo
98 287		Cristallo
98 290		Cristallo

ACCESSORI

Codice Articolo	Descrizione
98 292	Cristallo
98 324	Vetro
98 328	Cristallo
98 331	Vetro
98 335/01	Cristallo
98 335/03	Cristallo
98 335/04	Cristallo
98 343	Cristallo
98 348	Cristallo
98 350	Cristallo
98 351	Cristallo
98 355	Cristallo
98 360	Cristallo
98 368	Cristallo
98 370	Cristallo
98 385	Cristallo
98 390	Cristallo
98 392	Cristallo
98 396	Cristallo
98 425	Cristallo
98 429	Cristallo
98 487	Cristallo
98 490	Cristallo
98 492	Cristallo
98 512	Cristallo
98 523	Cristallo
98 534	Cristallo
98 545	Cristallo
98 556	Cristallo
98 560	Cristallo
98 583	Cristallo
98 603	Cristallo
98 625	Cristallo
98 669	Cristallo
98 716	Cristallo
98 749	Cristallo
98 807	Cristallo
98 831	Cristallo
98 864	Vetro
98 871	Cristallo Circolare
98 872	Pirex
98 873	Cristallo
98 878	Cristallo
98 911	Cristallo
98 950	Cristallo
98 953	Vetro
98 982	Cristallo
98 984	Cristallo
99 060	Lampada Led
99 061	Lampada Led
99 062	Lampada Led



Diamo Valore alle Emozioni

CONDIZIONI GENERALI DI VENDITA

CONDITIONS GENERALES DE VENTE

GENERAL SALES CONDITIONS

CONDICIONES GENERALES DE VENTA

ALLGEMEINE VERKAUFSBEDINGUNGEN

CONDIZIONI GENERALI DI VENDITA

- 1) I prezzi indicati sul listino si intendono per merce resa franca nostro stabilimento.
- 2) Le spedizioni vengono eseguite secondo le disponibilità di magazzino, garantendo la massima sollecitudine nel disbrigo dell'evasione dell'ordine. In caso di ritardata spedizione, il cliente non è autorizzato a sospendere i pagamenti in corso.
- 3) Tutte le spese di trasporto, imballo e postali sono ad esclusivo carico del Cliente.
- 4) La merce viaggia a rischio e pericolo del Cliente senza alcuna nostra responsabilità per eventuali ritardi, rotture, manomissioni e furto dei pacchi. Trascorsi 8 giorni dal ricevimento della merce non si accettano reclami.
- 5) Non verrà accettata merce in restituzione se non previo benestare della Società. In ogni caso le spese di ripristino, controllo e magazzinaggio verranno addebitate al cliente al costo.
- 6) Il pagamento se non diversamente concordato è da ritenersi per contrassegno.
- 7) Per i ritardati pagamenti alle scadenze pattuite contrattualmente, verranno applicati a decorrere dal giorno successivo a quello in cui doveva essere effettuato il pagamento, gli interessi moratori ex D.lgs. 231/2002. Il mancato pagamento comporterà inoltre il riaddebito di tutte le relative spese sostenute.
- 8) La Società garantisce la ottima qualità dei prodotti e si impegna a sostituire solo il materiale che risultasse difettoso per carenze produttive. È però espressamente escluso il risarcimento di ogni eventuale danno.
- 9) Le illustrazioni e le misure da noi fornite si intendono approssimative potendo i modelli subire lievi modifiche o variazioni senza obbligo di preavviso da parte della Società.
- 10) Per qualsiasi controversia dovesse insorgere tra la società e il cliente è competente il FORO di PARMA.

Matthews International S.p.A.

CONDITIONS GENERALES DE VENTE

- 1) Les prix indiqués sur le tarif s'entendent pour de la marchandise franco au départ de nos usines.
- 2) Les expéditions sont exécutées selon la disponibilité en magasin, en assurant une sollecitude maximale de l'exécution des commandes. En cas de retard de livraison, le client n'est pas autorisé à interrompre les paiements en cours.
- 3) Les frais postaux, de transport, et d'emballage sont au débit du client.
- 4) La marchandise voyage au risques et périls de l'acheteur; notre responsabilité est dégagée pour d'éventuels retards postaux, détériorations, effractions et vol des colis. Les réclamations ne sont pas admises que dans le délai de 8 jours suivant la réception de la marchandise.
- 5) Il ne sera pas acceptée de marchandise en retour sans autorisation préalable de la société. Dans tous les cas, les frais de réparation, contrôle et magasinage sont facturés au client.
- 6) Le paiement, si on ne s'accorde pas autrement, doit être effectué contre remboursement.
- 7) En cas de retard de paiement aux échéances, ils seront appliqués des intérêts moratoires ex D.lgs. 231/2002 à partir du jour après la date d'échéance. L'absence de paiement emportera l'imputation de tous les frais supportés.
- 8) La société garantie la qualité optimale de ses produits et s'engage à remplacer la marchandise défectueuse si elle résulte d'un défaut de production. Cependant, il ne peut y avoir de dommages et intérêts d'aucune sorte.
- 9) Les illustrations et les mesures qui vous sont données sont approximatives. En effet, les modèles peuvent subir de légères modifications ou variations sans obligation de préavis de la part de la société.
- 10) Pour toutes controverses, seul le tribunal de Parme est compétent.

Matthews International S.p.A

GENERAL SALES CONDITIONS

- 1) The price indicated on the price-list are meant ex-works in Parma.
- 2) Shipments are made according to the availability in stock, and we guarantee the maximum promptness of the shipment of the order. In case of a delayed shipment, the Customer is not entitled to stop the payments which are about to be made.
- 3) All expenses of transport, packaging and Post are charged to the purchaser.
- 4) Goods are shipped at the purchaser's risk. We hereby disclaim any responsibility for possible delays, breakages, tamperings and thefts of the parcels. After eight days from the receiving of the goods no claim is admitted.
- 5) The return of the goods will not be accepted, without our previous consent. In any case the Customer is debited with restoration, examination and storage expenses.
- 6) The payment if not otherwise agreed should be cash on delivery.
- 7) In case of a delayed payment, moratorium interests ex D.lgs. 231/2002 will be calculated after the expiration date. A non-payment will imply the debit of all the expenses.
- 8) Our firm guarantees the excellent quality of the products and undertakes to replace only the material which should be defective owing to production deficiencies. Compensation for any possible damage is however excluded.
- 9) The pictures and dimensions indicated in this catalogue are approximate. The models can be subjected to slight changes or variations without obligation to give notice on our part.
- 10) For any possible disputes, Parma court is chosen as the place of jurisdiction.

Matthews International S.p.A.

CONDICIONES GENERALES DE VENTA

- 1) El precio indicado en el listado se entiende la mercancía franca en nuestro establecimiento.
- 2) Las expediciones serán servidas según las disponibilidades de almacén, garantizando la máxima prontitud en los trámites de salida de los pedidos. En caso de retraso de la expedición el cliente no está autorizado a suspender los pagos en cursos.
- 3) Todos los gastos de transporte, embalajes y postales son con cargo exclusivo del comitente.
- 4) La mercancía viaja a riesgo y peligro del comitente sin nuestra responsabilidad por eventuales retrasos, roturas o robo del paquete. Transcurridos ocho días del recibo de la mercancía no se aceptan reclamaciones.
- 5) No vendrá aceptada mercancía en sustitución sin previa conformidad de la Empresa. En cada caso los gastos de restablecimiento, control y almacenaje son por cuenta del cliente al coste.
- 6) Los pagos salvo acuerdo pactado se entienden contra reembolso.
- 7) Por el retraso en los pagos en la fecha de vencimiento acordada serán aplicados a partir del día sucesivo a aquel en que se debió efectuar el pago, intereses moratorios iguales ex D.lgs. 231/2002. La falta de pago supondrá además el cargo de todos los gastos relativos soportados.
- 8) La Empresa garantiza la óptima calidad de los productos y se empeña en sustituir solo el material que resulta defectuoso por carencia productiva. Esta expresamente excluido el resarcimiento de cualquier eventual daño.
- 9) Las ilustraciones y las medidas de nuestros productos se entienden aproximadas, pudiendo los modelos sufrir leves modificaciones o variaciones sin obligación de preaviso por parte de la Empresa.
- 10) Para cualquier controversia Foro competente PARMA.

Matthews International S.p.A

ALLGEMEINE VERKAUFSBEDINGUNGEN

- 1) Die Preise verstehen sich ab Werk in Parma.
- 2) Die Lieferungen abhängt von Verfügbarkeit des Warenlager, im fall der verzögerten Lieferung hat der Kunde nicht das Recht laufende Zahlungen einzustellen.
- 3) Die Transportkosten, Verpackung und postisch fallen zu Lasten des Auftraggebers.
- 4) Die Ware reist auf Gefahr des Auftraggebers. Wir lehnen jegliche Verantwortung für eventuelle Verspätungen der Post, Schäden, Aufbrechen und Diebstähle der Pakete ab. Sind acht Tage nach dem Empfang der Ware vergangen, werden keine Reklamationen mehr angenommen.
- 5) Keine Rückerstattung von Waren kann ohne die vorherige Genehmigung der Firma stattfinden. Auf jeden Fall gehen die Lagerungs- und Instandsetzungskosten, sowie die Kosten für die Kontrolle, zu Lasten des Kunden.
- 6) Die Bezahlungen per Nachnahme erfolgen werden, außer besondere Fallen.
- 7) Im Fall der verzögerten Zahlung, es wird einen Zinssatz wie den ex D.lgs. 231/2002 auferlegt. Im Fall der fehlenden Zahlung die Kosten wird belastet.
- 8) Die Firma Caggiati versichert die ausgezeichnete Qualität der Produkte und verpflichtet sich die Ware, die auf Grund von Herstellungsmangeln fehlerhaft hervorgeht, zu ersetzen. Schadenersatz für mögliche Schäden ist aber von vornherein ausgeschlossen.
- 9) Sowohl die Bilder als auch die Größen, die in den vorliegenden Katalogen enthalten sind, sind annähernd. Alle Modelle unterliegen möglichen kleinen Änderungen. Die Firma ist aber keineswegs, den Kunden im voraus davon in Kenntnis zu setzen.
- 10) Falls sich Streitigkeiten ergeben, wählen wir Parma als zuständigen Gerichtsstand.

Matthews International S.p.A

Immagini Fotografiche:
Aleandro Battistini - Studio Gamma - Alfredo Ferrari
Studio Habits Milano - Grafiche Step - Rete Mirabile

Grafica:
Nicola Bardò

Stampa:
Grafiche Step
Parma

Finito di stampare nel mese di Giugno 2018

Matthews International S.p.A.

Sede Legale ed Uffici Direzionali: Via Martiri della Libertà, 71 - 43052 Colorno - Parma - Italy
Cap. i.v. € 2.500.000,00 - Partita Iva 02104230343 - Codice Fiscale 12475620154
Tel. +39 0521 5208 - Fax +39 0521 521148/0521 816777 - www.matw.it - servizio.clienti@matw.it

Uffici Commerciali ed Assistenza Clienti: Via Galileo Galilei, 1 - 43052 Colorno - Parma - Italy
Tel. +39 0521 815801 - Fax verde 840 022444 - www.caggiati.it - servizio.clienti@caggiati.it

Matthews International S.p.A.
Sede Legale ed Uffici Direzionali:
Via Martiri della Libertà, 71
43052 Colomo - Parma - Italy
Cap. i.v. € 2.500.000,00
Partita Iva 02104230343
Codice Fiscale 12475620154
Tel. +39 0521 5208
Fax +39 0521 521148/0521 816777
www.matw.it - servizio.clienti@matw.it

Uffici Commerciali ed
Assistenza Clienti:
Via Martiri della Libertà, 71
43052 Colomo - Parma - Italy
Tel. +39 0521 815801
Fax verde 840 022444
www.caggiati.it
servizio.clienti@caggiati.it

Finito di stampare in Giugno 2018

Caggiati[®]

Matthews
INTERNATIONAL SPA